

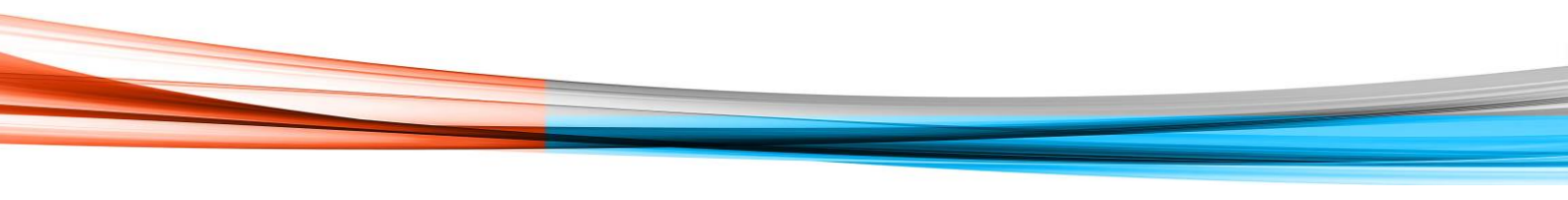

# **Operating and infrastructure options for increasing flood mitigation at Lake Eppalock**

## **Technical assessment report**

**November 2023**



### Document status

Client	Department of Energy, Environment and Climate Action
Project	Operating and infrastructure options for increasing flood mitigation at Lake Eppalock
Report	Technical assessment report
Project manager	Simon Lang
File name	VIC00115_R_LakeEppalock-FloodMitigation-FinalForWeb
Project number	VIC00115

### Document history

Version	Date issued	Reviewed by	Approved by	Sent to	Comment
Milestone 1	July 2023	P. Hill	S. Lang	DEECA	For review
Milestone 2	October 2023	D. Stephens	S. Lang	DEECA, GMW, NCCMA	For review
Draft	Nov. 2023	S. Lang	S. Lang	Stakeholder group	For review
Final	Nov. 2023	S. Lang	S. Lang	DEECA	For review
Final for website	Nov. 2023	S. Lang	S. Lang	DEECA	For public release

### Copyright and Limitation

This report has been produced by Hydrology and Risk Consulting Pty Ltd (“HARC”) for the Department of Energy, Environment and Climate Action. Unless otherwise indicated, the concepts, techniques, methods and information contained within the report are the intellectual property of HARC and may not be reproduced or used in any form by third parties without the express written consent of HARC and the Department of Energy, Environment and Climate Action.

The report has been prepared based on the information and specifications provided to HARC by the Department of Energy, Environment and Climate Action. HARC does not warrant this document as being complete, current or free from error and disclaims all liability for any loss, damage, costs or expenses (including consequential losses) relating from this report. It should only be used for its intended purpose by the Department of Energy, Environment and Climate Action and should not be relied upon by third parties.

Copyright © Hydrology and Risk Consulting Pty Ltd ACN 603 391 993. All rights reserved.

## Contents

<b>Summary report</b>	<b>4</b>
<b>1. Introduction</b>	<b>18</b>
1.1 Project scope	18
1.2 Project context	19
1.3 This report	19
1.4 Models used	20
1.5 Terminology	21
<b>2. Lake Eppalock</b>	<b>22</b>
2.1 Storage information	22
2.2 Catchment details	23
2.3 Historic storage behaviour	25
2.4 Influence on Rochester floods	27
<b>3. Previous studies</b>	<b>29</b>
3.1 State Rivers and Water Supply Commission (1947)	29
3.2 State Rivers and Water Supply Commission (1959)	29
3.3 State Rivers and Water Supply Commission (1974)	30
3.4 SKM (2012a)	30
3.5 Water Technology (2013 & 2018)	33
3.6 HARC (2017 & 2019)	35
<b>4. Options investigated</b>	<b>36</b>
4.1 Selection method	36
4.2 Reduce target storage	37
4.3 Reduce target storage and increase outlet capacity	37
4.4 Reduce full supply level using a spillway slot	38
4.5 Add spillway gates	39
4.6 Reconfigure spillways	40
4.7 Summary	41
<b>5. Water resource implications</b>	<b>42</b>
5.1 Method	42
5.2 Results	44
<b>6. Flood frequency changes – Lake Eppalock</b>	<b>51</b>
6.1 Method	51
6.2 Revised spillway ratings	53
6.3 Pre-releases in response to forecasts	57
6.4 Results	60
6.5 Sensitivity testing using the SGEFM in place of the GSM	64

<b>7.</b>	<b>The 2011 and 2022 floods</b>	<b>67</b>
7.1	Historical information	67
7.2	Potential changes if options were implemented	70
7.2.1	If existing outlet capacity was retained	70
7.2.2	If pre-releases were made in response to forecasts	72
7.2.3	If start storage was lower, or spillways modified	75
<b>8.</b>	<b>Concept designs and capital costs</b>	<b>79</b>
8.1	Infrastructure options	79
8.1.1	Increased outlet capacity	79
8.1.2	Spillway slot	81
8.1.3	Spillway gates	83
8.1.4	Piano key spillways	86
8.2	Costs to offset supply reliability changes	89
8.2.1	Estimated using the GSM	89
8.2.2	Sensitivity testing using the SGEFM	93
8.3	Initial capital cost summary	94
<b>9.</b>	<b>Upstream impacts</b>	<b>98</b>
9.1	Reduced target storage or full supply level	98
9.2	Increased reservoir level during floods	100
<b>10.</b>	<b>Changes to downstream flow regime</b>	<b>104</b>
10.1	Monthly time-step assessment	104
10.2	Daily time-step assessment	106
10.3	Traditional Owner feedback	111
<b>11.</b>	<b>Changes to downstream flooding</b>	<b>112</b>
11.1	Flood class extents in Rochester	112
11.2	Potential changes if options were implemented	113
11.2.1	Flood peaks in Rochester	113
11.2.2	Flood damages	115
11.3	Options ranking (avoided damages vs initial capital cost)	121
<b>12.</b>	<b>Conclusion</b>	<b>124</b>
<b>13.</b>	<b>References</b>	<b>128</b>
	Appendix A General dam arrangements	130
	Appendix B Options not assessed in detail	135
	Appendix C Concept design drawings	139
	Appendix D Method to estimate flood damages	159
	Appendix E Future impacts of climate change	164



## Summary Report

### Introduction

This is a summary of outcomes from the technical assessment of potential operating and infrastructure options for increasing the flood mitigation provided by Lake Eppalock. The technical assessment was commissioned by the Department of Energy, Environment and Climate Action (DEECA) following the October 2022 flood in the Campaspe River basin.

### Lake Eppalock

Lake Eppalock was constructed between 1960 and 1964 to store water for consumptive use. The water stored at Lake Eppalock is used to supply private diverters (irrigators), meet environmental water demands along the Campaspe River, underpin urban water security for Bendigo and a number of other towns, and meet trade commitments to the River Murray

The full supply level (FSL) at Lake Eppalock is 193.91 m AHD, at which 304,650 ML (304.65 GL) is held in storage. This capacity is shared 82% : 18% between Goulburn-Murray Water (GMW) and Coliban Water respectively. The maximum capacity of the outlet for releasing water downstream is approximately 1,600 ML/d.

The storage behaviour at Lake Eppalock from the mid-1990s onwards has been distinctly different compared with the period from the mid-1960s to mid-1990s (Figure 1). Before the mid-1990s, Lake Eppalock filled and spilled most years, and was rarely drawn down below 50% of FSL (approximately 150,000 ML). Spills were typically below or slightly above the minor flood threshold at Eppalock.

Since the mid-1990s, the reservoir levels at Lake Eppalock have typically been lower and for longer periods of time compared with the earlier period. The frequency of spills from storage has therefore reduced. However, two of the spills (January 2011 and October 2022) are by far the largest in the historic record.

The Lake Eppalock catchment encompasses an area of approximately 2,030 km<sup>2</sup>, and the catchment area of the Campaspe River between Lake Eppalock and Rochester is approximately 1,370 km<sup>2</sup>. There is a strong correlation between the peak spill from Lake Eppalock and the peak flow at Rochester, with the peak flow at Rochester typically being 1.2 to 3.3 times the peak spill from Lake Eppalock (Figure 2).

If the flood mitigation provided by Lake Eppalock can be increased, flood frequencies in Rochester would be likely to decrease. However, the correlation between Lake Eppalock spills and flooding in Rochester is not perfect. This is because of the catchment area and the tributaries of the Campaspe River between Lake Eppalock and Rochester. If rainfall is heaviest in the region downstream of the dam rather than upstream, significant flooding at Rochester can occur even if there is minimal flooding at Lake Eppalock. For example, in August 1983 there was major flooding in Rochester, even though the spill from Lake Eppalock was just above the minor flood threshold at Eppalock.

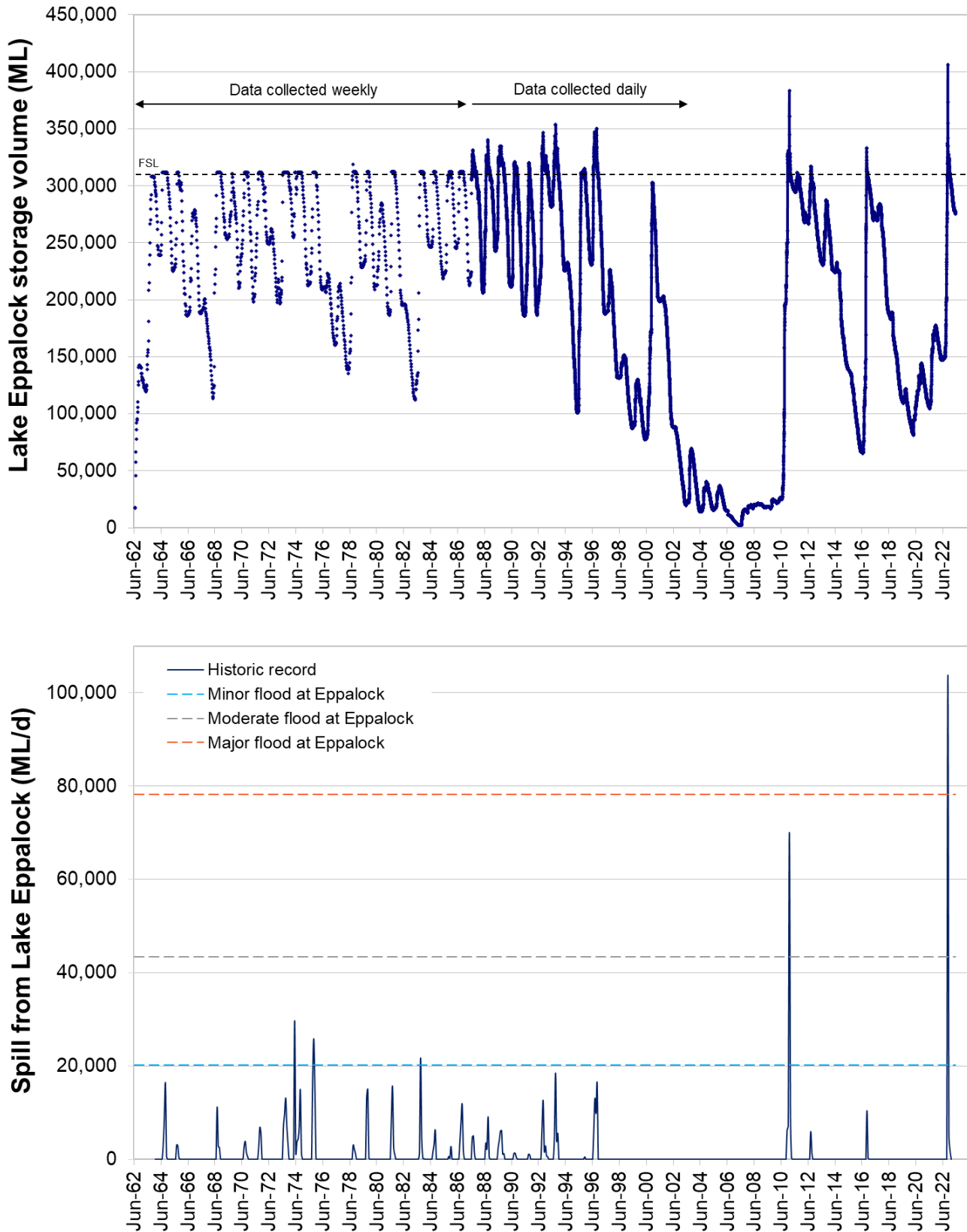

Figure 1: Recorded storage volumes (top) and spills from Lake Eppalock (bottom) for the period from June 1962 to April 2023. Data supplied by GMW.

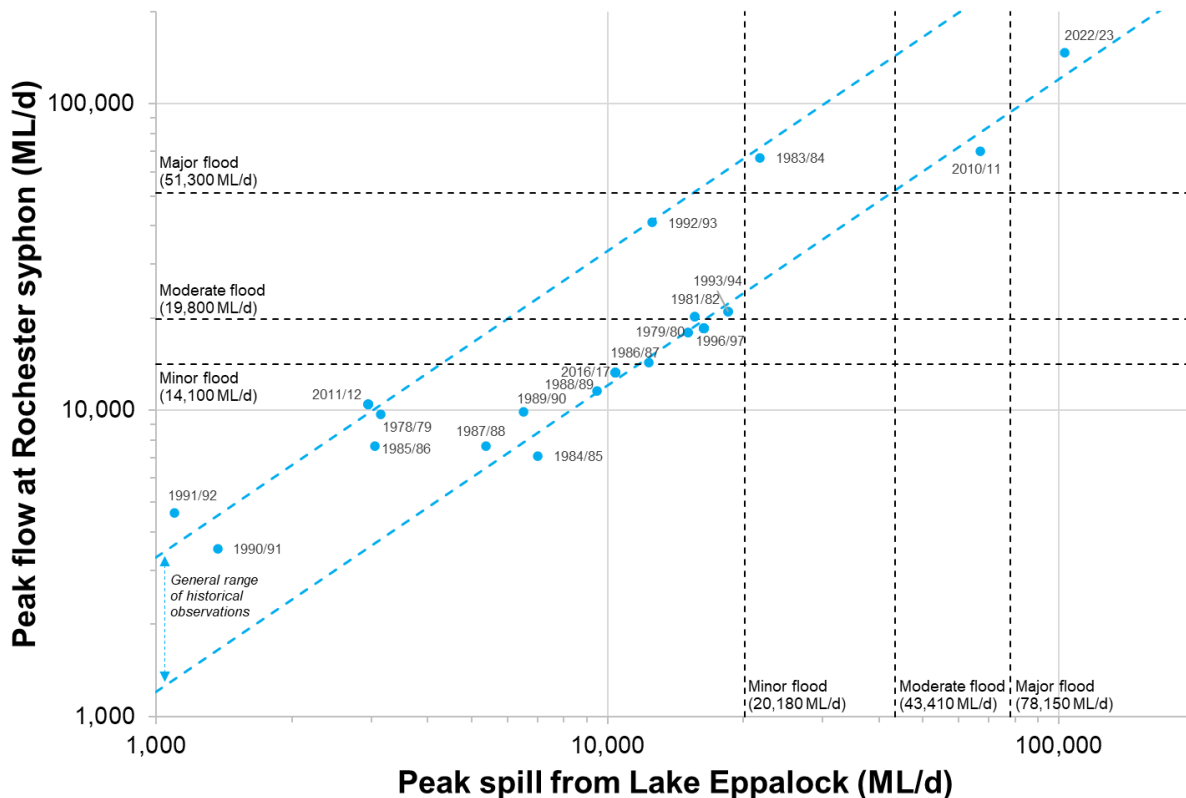

Figure 2: Peak spills from Lake Eppalock versus peak flows at the Rochester syphon for each water year post-1975, shown as a scatter plot

## Options investigated for increasing the flood mitigation provided by Lake Eppalock

This technical assessment of potential operating and infrastructure options for increasing the flood mitigation provided by Lake Eppalock has examined five options:

- The first three of the options involve lowering the target storage or FSL at Lake Eppalock. These options would therefore reduce the volume of water stored in the Campaspe system for entitlement holders.
- The other two options would maintain the existing FSL at Lake Eppalock, but hold more water behind the dam wall during floods. These options would therefore increase the number of recreational and commercial tourism sites around Lake Eppalock that are inundated during floods.

These options were selected based on a workshop with DEECA, Goulburn-Murray Water, Coliban Water, Central Highlands Water, the Victorian Environmental Water Holder, the North Central Catchment Management Authority, Bendigo City Council and Campaspe Shire Council. The five options are described below.

Five other options were also considered during the workshop or later stages of the project. These included the transfer of water to Greens Lake or Lake Cooper. However, these options were not assessed to the same level of detail, because they are unlikely to significantly increase the flood mitigation provided by Lake Eppalock, or improve upon the five options selected.

For example, Greens Lake and Lake Cooper were already near or above capacity during the 2011 flood, and in October 2022 the spare capacity in Greens Lake was a small fraction of the inflows to Lake Eppalock.

***Option 1: Reduce Lake Eppalock target storage using existing infrastructure***

This option involves using the existing outlet for downstream releases to hold the storage – to the degree possible – below or at a targeted proportion of FSL, rather than allowing Lake Eppalock to fill to FSL. The additional airspace in Lake Eppalock would further reduce flood peaks as events passed through the storage. In this technical assessment, options to reduce the target storage to 50%, 70% or 90% of the current FSL were investigated.

The degree to which this option reduces peak outflows from Lake Eppalock would vary by event because the current outlet capacity is only 1,600 ML/d. For example, in 2011 and 2022 inflows in the months prior to the floods were such that the storage could not have been held at a defined target (e.g. 70% or 90% of FSL) before either event.

***Option 2: Reduce Lake Eppalock target storage and increase outlet capacity***

This option involves reducing the target storage at Lake Eppalock, and increasing the downstream outlet capacity so that operators have greater ability to release water from storage during intervals between floods. To implement this option, a second downstream outlet would be required at Lake Eppalock, because of the anticipated dam safety risks associated with expanding the existing outlet.

For this technical assessment, an outlet capacity of 5,000 ML/d was selected. A total release of 5,000 ML/d from Lake Eppalock is below thresholds that have historically caused flooding at Rochester (Figure 2), the additional 3,400 ML/d outlet capacity would be sufficient to deliver the 1,800 – 2,000 ML/d winter freshes recommended for the Campaspe River, and this outlet capacity would have been sufficient to hold Lake Eppalock at a target storage below FSL in the lead-up to the 2011 and 2022 floods.

***Option 3: Reduce Lake Eppalock full supply level using a spillway slot (e.g. Figure 3)***

Permanently reducing the FSL at Lake Eppalock is another way of increasing the amount of airspace in storage prior to a flood. The option considered in this technical assessment was installing a passive spillway slot to lower FSL by approximately 3 m, which would reduce the volume held when the storage is full to 70% of the current FSL. However, inflows to storage preceding a flood may mean that the lake level is above 70% of FSL before the event arrives.



Figure 3: An example of a spillway slot – Hinze Dam in Queensland



#### **Option 4: Add spillway gates**

The three options above all reduce the water stored in Lake Eppalock for entitlement holders. In contrast, this option involves adding spillway gates to the primary spillway, and maintaining the existing FSL. Having spillway gates at Lake Eppalock would potentially allow the storage operators to reduce peak outflows during floods by surcharging the reservoir to levels higher than would otherwise occur with a fixed crest spillway. However, surcharging the reservoir during floods would increase the number of recreational sites and buildings around Lake Eppalock that are inundated compared with current conditions.

The uncertainty in rainfall forecasts constrains the degree to which storage operators can confidently make pre-releases without either a) releasing water that cannot be replaced by subsequent inflows or b) exacerbating downstream flooding. Therefore, the concept design for this option was based on adding gates to the existing spillway (to minimise the cost), rather than lowering the spillway crest and using the gates to maintain the existing FSL.

#### **Option 5: Reconfigure spillways, by installing piano key spillways (e.g. Figure 4)**

The last option selected for assessment was reconfiguring the primary, secondary and tertiary spillways – without reducing FSL or adding spillway gates – so that more storage at Lake Eppalock is utilised during floods. The method selected for investigation was the installation of piano keys on part of the primary spillway and all of the secondary spillway. A piano key spillway was added to Loombah Dam in north-east Victoria in 2013.

By adding piano keys either side of the central portion of the primary spillway, a slot could be created through which Lake Eppalock outflows below a given threshold would be ‘throttled’. Once flows were above this threshold the keys would engage to increase the spillway flow and thus ensure dam safety is not compromised. Piano keys would also be required on the secondary spillway, and an erodible crest raise on the tertiary spillway, so that the frequency at which these emergency spillways are operating does not increase despite the changes to the primary spillway. As per the addition of spillway gates, during floods this option would increase the number of recreational sites and buildings around Lake Eppalock that are inundated compared with current conditions



Figure 4: An example of a piano key spillway (<https://www.hydropower.org/blog/climate-resilience-case-study-piano-key-weirs>)

## Assessment method

For each option, the water resource implications, flood frequency changes at Lake Eppalock, anticipated changes to 2011 and 2022 spills from Lake Eppalock (if the events were repeated), concept designs and initial capital costs<sup>1</sup>, upstream water level implications, downstream flow regime changes, and potential reductions of tangible flood damages<sup>2</sup> have been considered.

The assessment was informed by applying existing water resource and flood hydrology models, and using historical datasets. Results from the technical analyses completed are suitable for high-level comparisons between current conditions and what is anticipated if the options were implemented. The relative differences between options are not expected to change significantly as models are updated or more work is completed, but specific values quoted in this report will become superseded.

## Changes to flooding if the 2011 or 2022 events were repeated

Adopting a target storage of 70% or 90% below FSL using the existing infrastructure at Lake Eppalock would not have significantly changed the outcomes observed in January 2011 and October 2022. This is because in 2011 and 2022 inflows in the months prior to the floods were such that the storage could not have been held at a defined target before either event. Likewise, releasing water from storage in response to rainfall forecasts will not be a feasible way of significantly reducing flood frequencies downstream of Lake Eppalock for the foreseeable future because of forecast uncertainties. The full technical assessment report includes more detail to support these statements.

For the other options assessed, Figure 5 shows how the outflows from Lake Eppalock and the reservoir levels would differ if the 2011 flood were repeated. The option to reduce the Lake Eppalock target storage and increase the outlet capacity is represented by the 90%, 70% or 50% start storage curves. Not surprisingly, as the start storage is lowered, the peak outflow from Lake Eppalock reduces. The spillway slot, spillway gates and piano keys spillways options all have similar peak outflows, but different upstream water levels.

Figure 6 is a similar analysis of the 2022 flood. This demonstrates that the degree to which the options will increase the flood mitigation provided by Lake Eppalock will vary from event to event. In this case the 90% start storage option provides the least additional flood mitigation. The same amount of additional flood mitigation is provided by the spillway slot and piano keys spillways options, and more flood mitigation comes from the spillway gates or lower reservoir start storages. For this technical assessment, the spillway gates design and high-level operational rules were based on the 2022 flood. If the spillway gates option is pursued further, the design and operational rules would need to be refined so that trade-off between upstream and downstream flooding is better optimised across a range of potential future flood scenarios.

---

<sup>1</sup> The design and construction costs for the works were estimated to a AACE Class 5 level, which are typically within -50% to +100% of the true cost. The scope of work did not include estimating the additional operation and maintenance costs for new infrastructure, or the ongoing socio-economic costs of reducing the volume of water stored in the Campaspe system.

<sup>2</sup> This analysis does not account for the intangible damages caused by flooding, such as mental health impacts for individuals, or unwanted changes to community dynamics.

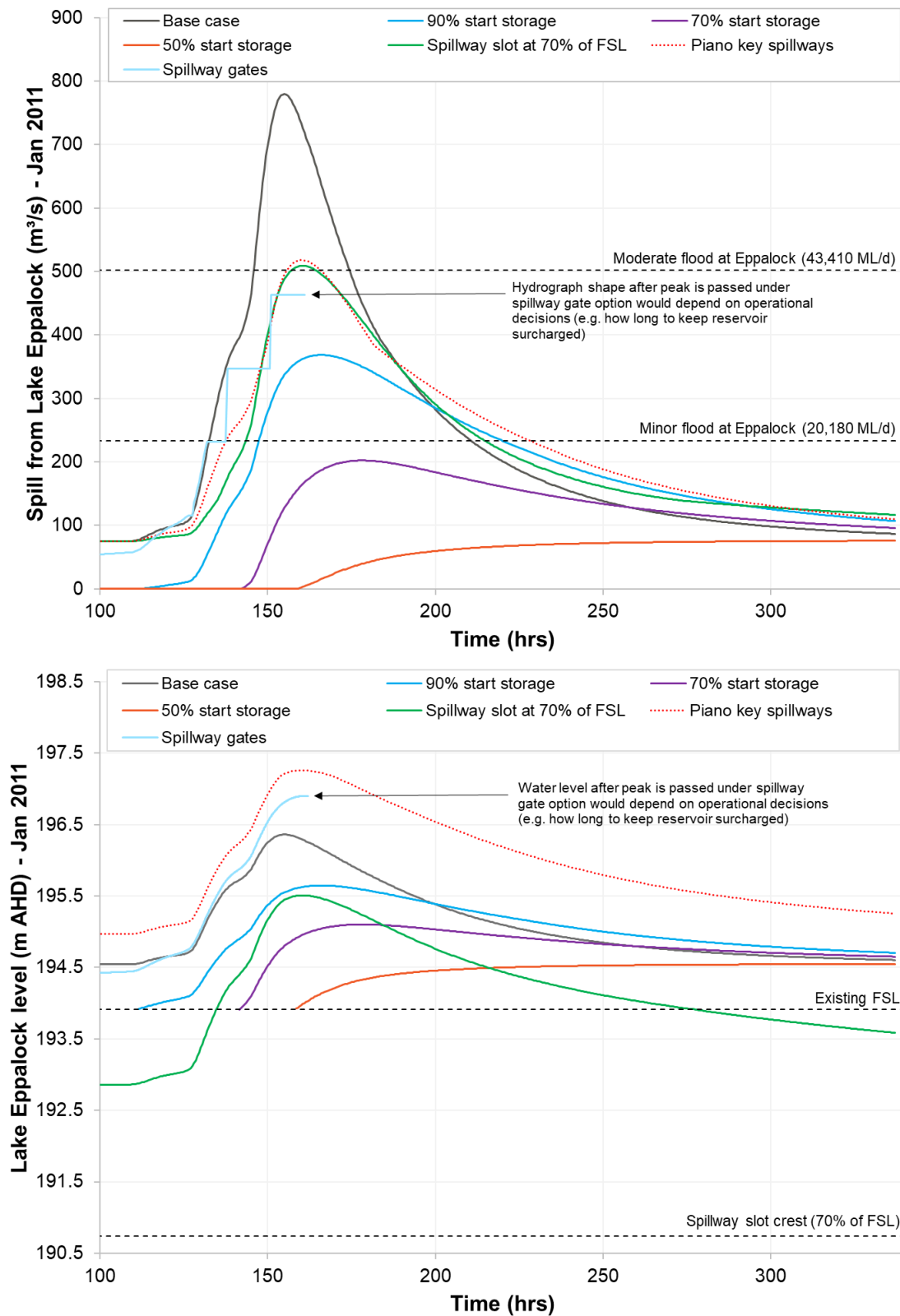

Figure 5: The modelled (in RORB) changes that various options would make to the outflows from Lake Eppalock (top) and reservoir level (bottom) if the January 2011 flood were repeated. A 90%, 70% or 50% start storage would only have been achievable with an increased outlet capacity. 1 m³/s equals 86.4 ML/d.

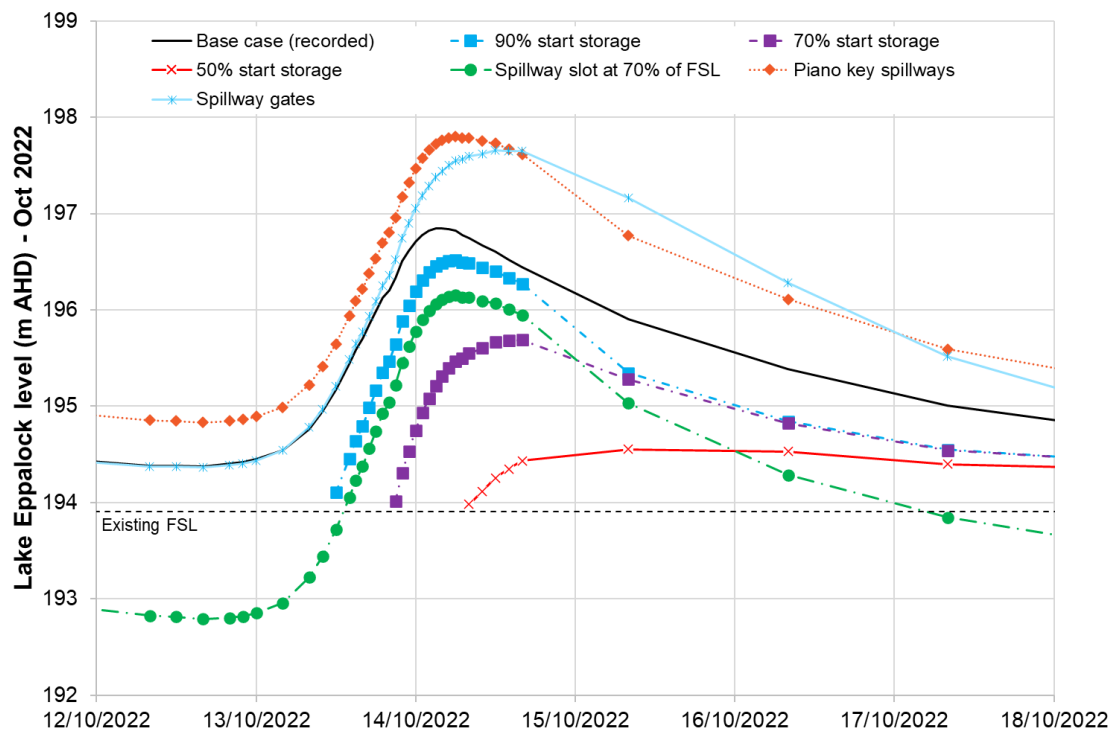
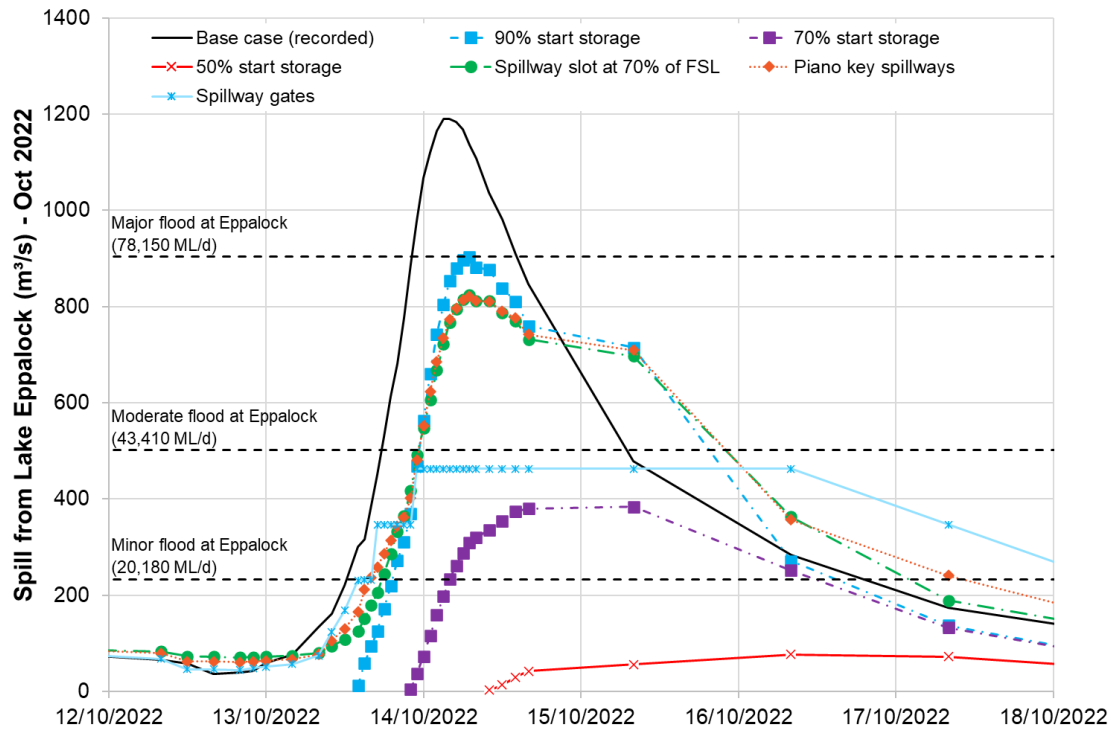

Figure 6: The modelled (in a spreadsheet) changes that various options would make to the outflows from Lake Eppalock (top) and reservoir level (bottom) if the October 2022 flood were repeated. A 90%, 70% or 50% start storage would only have been achievable with an increased outlet capacity. 1 m<sup>3</sup>/s equals 86.4 ML/d.



Table 1 summarises the peak outflows in Figure 5 and Figure 6, and provides an indicative assessment of how the options would have changed peak flows in Rochester, the flood damages upstream of Lake Eppalock, and the flood damages from Lake Eppalock to Rochester. The flood damage values combine damages estimated for buildings and contents (residential and non-residential), vehicles, road and rail, and agriculture. All options would reduce flood damages downstream, but the spillway gates and piano keys spillways options would increase flood damages upstream (Table 2).

Table 1: A summary of how the options would reduce the flood damages if the 2011 or 2022 events were repeated. A 90%, 70% or 50% start storage would only have been achievable with an increased outlet capacity.

Option	Approximate peak flow (ML/d)		Approximate flood damages (in millions)			
	Eppalock spill	Rochester syphon	Upstream of Eppalock	Eppalock to Rochester*	Total (rounded)	Difference v base case
2011 – base case	70,000	^84,000	\$7	(1700) \$200	\$205	-
2011 – 50% start storage	7,000	8,500	-	~\$0	~\$0	\$205
2011 – 70% start storage	17,500	21,000	-	(50) \$15	\$15	\$190
2011 – 90% start storage	32,000	38,500	-	(340) \$40	\$40	\$165
2011 – spillway gates	40,000	48,000	\$15	(600) \$75	\$90	\$115
2011 – slot spillway at 70%	44,000	52,800	-	(800) \$95	\$95	\$110
2011 – piano key spillways	44,000	52,800	\$20	(800) \$95	\$115	\$90
2022 – base case	103,000	^123,500	\$15	(>2000) \$360	\$375	-
2022 – 50% start storage	7,000	8,500	-	~\$0	~\$0	\$375
2022 – 70% start storage	33,000	39,500	-	(360) \$45	\$45	\$330
2022 – 90% start storage	78,000	93,500	\$8	(1970) \$250	\$260	\$115
2022 – spillway gates	40,000	48,000	\$25	(600) \$75	\$100	\$275
2022 – slot spillway at 70%	71,000	85,000	-	(1800) \$220	\$220	\$155
2022 – piano key spillways	71,000	85,000	\$30	(1800) \$220	\$250	\$125

^ To consistently relate the peak spill from Lake Eppalock to an approximate peak flow at Rochester syphon, the lower blue-dotted lines shown in Figure 2 have been used. This means the values here are different to those recorded at the Rochester syphon gauge in 2011 (~70,000 ML/d) and 2022 (~140,000 ML/d).

\* The values in brackets are the approximate number of houses affected from Lake Eppalock to Rochester.

Table 2: Estimates of the number of buildings inundated around Lake Eppalock during the 2011 and 2022 floods, and if the floods were repeated with the spillway gates or piano keys spillways options implemented

Year / option	Estimated number of buildings inundated upstream of Lake Eppalock	
	Total	Difference to base case
2011 – base case	60	-
2011 – add spillway gates	120	60
2011 – piano key spillways	170	110
2022 – base case	110	-
2022 – add spillway gates	225	115
2022 – add piano key spillways	270	160

## Water resource implications

The options that involve lowering the target storage or FSL at Lake Eppalock would reduce the reliability of supply to entitlement holders in the Campaspe system (Table 3), and the volume of water supplied to urban and rural customers in the Coliban system (Table 4), if existing entitlements and water shares are maintained. This is because less water would be held in storage (Figure 7).

To return the reliability of supply to levels expected under current conditions, approximately 15%, 33% or 55% of the combined high- and low-reliability entitlements and water shares in the Campaspe system would need to be recovered if the target storage or FSL was reduced to 90%, 70% or 50% respectively. At present, irrigators and water corporations hold approximately 60% of the total entitlements and water shares in the Campaspe system, and the environment – via the Victorian and Commonwealth environmental water holders – has the other 40%.

The socio-economic consequences of additional water recovery in the Campaspe system, and the mechanisms by which this may happen (e.g. purchases via the water market or changes to bulk or environmental entitlements) have not been assessed. Lowering the Lake Eppalock target storage or FSL would also increase the distance between recreational facilities (e.g. boat ramps and holiday accommodation) and the water's edge.

**Table 3: Modelled average February allocations to high-reliability water shares (HRWS) and low-reliability water shares (LRWS) in the Campaspe and Goulburn systems**

Option	Average modelled February allocations (July 1891 – June 2022)			
	Campaspe system		Goulburn system	
	HRWS	LRWS	HRWS	LRWS
Base case	<b>94%</b>	<b>76%</b>	<b>97%</b>	<b>50%</b>
90% target storage	94%	71%	97%	50%
70% target storage / FSL	93%	60%	97%	50%
50% target storage	87%	45%	97%	50%

**Table 4: Modelled change in average annual volume supplied to the Coliban system from Lake Eppalock**

Option	Modelled supply from Lake Eppalock to Coliban system (July 1891 – June 2022)	
	Average annual volume (ML)	Difference to base case (ML)
Base case	9,200	-
90% target storage	8,900	300
70% target storage / FSL	8,600	600
50% target storage	7,700	1,500

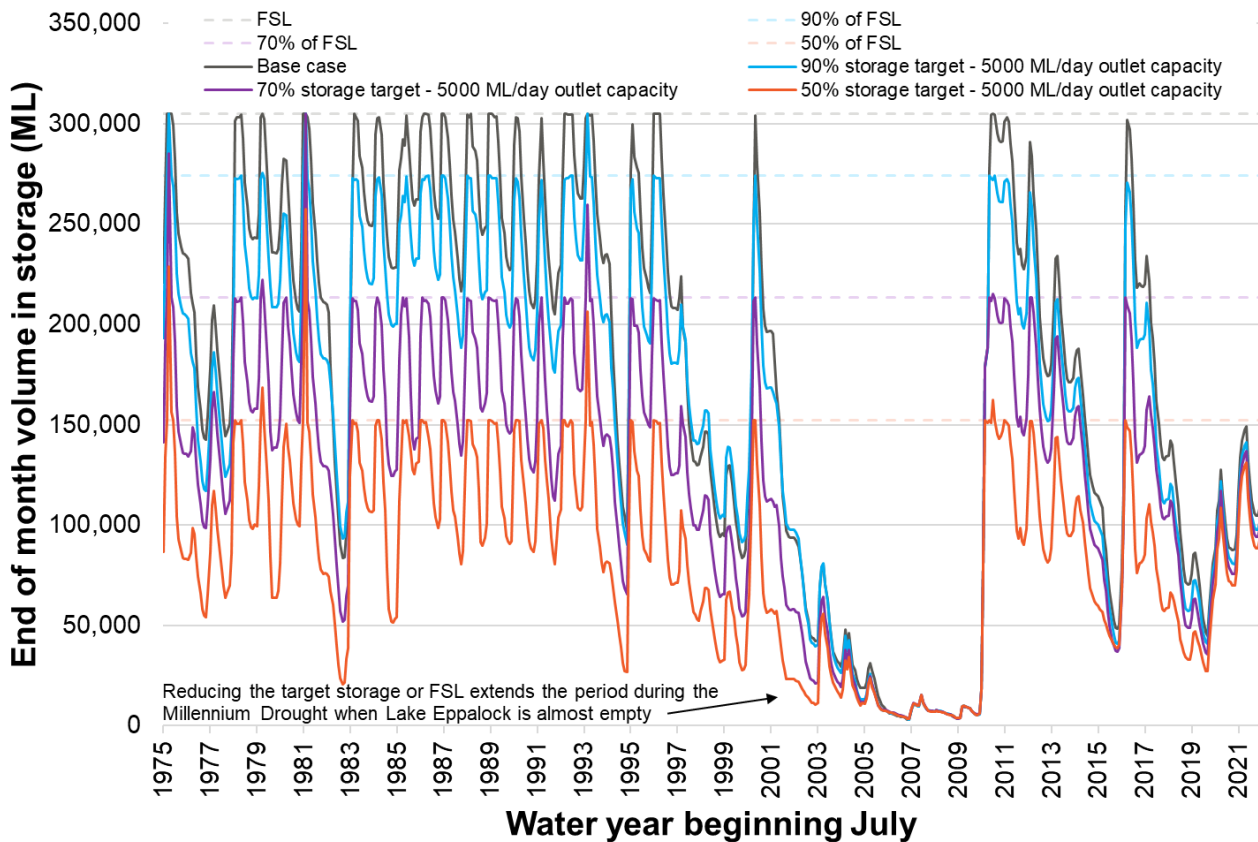

Figure 7: Monthly time-series of the modelled storage trace for Lake Eppalock, from January 1975 to June 2022, for the option to reduce target storage to 50%, 70% or 90% of FSL using a 5,000 ML/d outlet capacity

### Downstream flow regime

If the target storage at Lake Eppalock is lowered using the existing outlet capacity, there will be a reduction of flows in winter and early spring and increased flows in late spring and early summer. This is because the outlet will often be operating near the 1,600 ML/d capacity during late spring and early summer to bring the reservoir level back to the target storage, and in winter and early spring there will be more airspace compared with the base case and hence less spills. This shift of the flow regime downstream of Lake Eppalock would be likely to cause some negative environmental impacts.

In contrast, the options that include an increased outlet capacity or spillway slot are likely to have a neutral or positive impact on the downstream environment, because they provide for larger (but within bank) flows in winter and early spring. For the increased outlet capacity option, this conclusion is based on the assumption that releasing flows from storage at up to 5,000 ML/d, which is higher than the 1,800 – 2,000 ML/d winter fresh flow recommendation downstream of Lake Eppalock but less than the 10,000 ML/d – 12,000 ML/d bankfull flow recommendation, will not have detrimental environmental impacts. This assumption will need to be tested in future.

Further investigation will also be required to weigh the potential benefit of having higher flows down the Campaspe River if the target storage or FSL is lowered at Lake Eppalock, against the cost of having less water stored for environmental use in dry periods (e.g. the early 2000s period in Figure 7). The minimum flows passed downstream of Lake Eppalock would also decrease under current bulk entitlement rules if less water is held in storage.

## Ranking of options

Modelled flood frequencies were combined with estimates of how flood damages vary according to Lake Eppalock outflows to produce approximate values of average annual damages for the base case (current conditions) and options assessed. The estimates of average annual damages will increase once flood hydrology and hydraulic modelling is updated using rainfall, streamflow and inundated area records available for the October 2022 event, but are still useful for ranking the options investigated.

Table 5 shows how the avoided flood damages if the options were in place compare with the initial capital cost, assuming a 50-year horizon, a 6% discount rate and ignoring any increase in operation and maintenance costs. For the reasons stated below the table, the benefit to cost ratios are approximate and will change if the options are investigated in more detail.

Colours have been added to the rows to highlight three groupings across the options. The options to reduce the target storage or FSL to 70% of the current FSL using an increased outlet capacity or passive spillway slot – shaded blue – have the highest ratio of avoided damages to initial capital cost (Table 5). The ratio is lower for the options to reduce the target storage at Lake Eppalock to 90% or 50%. These are shaded yellow. The options to maintain the existing FSL and add spillway gates or piano keys spillways – coloured orange – have the lowest benefit to cost ratio. The option to reduce the target storage at Lake Eppalock using the existing outlet capacity is not shown because it is not a robust option.

This ranking of the options however, does not account for the ongoing socio-economic consequences of reducing the volume of water stored for entitlement holders in the Campaspe system, and the recreational impacts of holding the Lake Eppalock water level below FSL. Therefore, before one or more option is selected as the preferred option(s) for further investigation:

- Results from this technical assessment will need to be compared with outcomes from the update of the Rochester flood management plan that is underway.
- The socio-economic consequences of reducing the volume of water stored in the Campaspe system need to be modelled.
- An assessment – informed by consultation with entitlement holders – is needed about the mechanisms available to change water sharing arrangements, to allow airspace to be maintained in Lake Eppalock without reducing water supply reliability and/or compromising water pricing in the Campaspe system.



If changing the water sharing arrangements in the Campaspe system is not feasible, then the options to reduce the target storage or FSL at Lake Eppalock are not worth pursuing further. If the arrangements can be changed, further work is required to optimise the trade-off between the socio-economic, recreational, environmental and cultural consequences of reducing the target storage or FSL, and the additional flood mitigation provided.

**Table 5: Estimates of avoided damages vs initial capital cost, assuming a 50-year horizon, a 6% discount rate and ignoring any increase in operation and maintenance costs.**

Option	Approximate benefit-cost (50 years, 6% discount)		
	Avoided damages (\$ m) <sup>^</sup>	Initial capital cost (\$ m) <sup>*</sup>	Ratio
Slot spillway at 70% FSL	30.3 – 39.3	40	0.8 – 1.0
70% target storage + 5,000 ML/d outlet	41.8 – 60.8	65	0.6 – 0.9
90% target storage + 5,000 ML/d outlet	22.3 – 35.6	45	0.5 – 0.8
50% target storage + 5,000 ML/d outlet	51.2 – 71.2	105	0.5 – 0.7
Piano key spillways	24.5 – 32.4	60	0.4 – 0.5
Spillway gates	23.6 – 41.2	200	0.1 – 0.2

<sup>^</sup> The estimates of avoided damages are approximate, because:

- The relationship between spills from Lake Eppalock and flood damages from Lake Eppalock to Rochester is approximate, and has been extrapolated.
- Flood damages downstream of Rochester have not been considered.
- Estimates of the avoided damages will increase once the flood hydrology and hydraulic modelling is updated using rainfall, streamflow and inundated area records available for the October 2022 event.

<sup>\*</sup> For the estimates of costs:

- The design and construction costs for the works were estimated to a AACE Class 5 level, which are typically within -50% to +100% of the true cost.
- The costs associated with recovering water to offset the supply reliability impacts are approximate.
- The ongoing socio-economic costs associated with reducing the volume of water stored in the Campaspe system (if the target storage or FSL at Lake Eppalock is reduced) are not included.
- The additional operation and maintenance costs of new infrastructure are not included.

## Recommended further work

Before further work is done on the potential operating and infrastructure options for increasing the flood mitigation provided by Lake Eppalock, the RORB model of the catchment and dam should be re-calibrated and re-verified using rainfall and streamflow records available for the 2022 flood. DEECA should also consider using the daily Goulburn-Broken-Campaspe-Coliban-Loddon Source model during future assessments of the water resource and downstream flow regime implications, rather than continuing to use the monthly Goulburn Simulation Model that was made available for this study.

If the water sharing arrangements in the Campaspe River catchment are able to be changed, further investigations are needed before the trade-offs can be optimised. This includes:

- Assessing the socio-economic consequences of reducing the volume of water stored in the Campaspe system
- Considering the costs and benefits of different potential ways for recovering or retiring entitlements and water shares
- Refining the assessment of flood damages, and how these vary according to peak outflows from Lake Eppalock
- Refining the initial assessments of the expected costs and benefits to existing recreational, environmental and cultural values around Lake Eppalock and downstream
- Refining the design and cost estimates for the increased outlet capacity, and optimising the outlet size by balancing the associated cost with the flood mitigation and operational benefits provided by the increased capacity.

If the water sharing arrangements cannot be changed and therefore only infrastructure options are possible for increasing the flood mitigation provided by Lake Eppalock, additional work will be required to optimise the design of the spillway gates or piano key spillways, to provide the best possible trade-off between costs, the upstream impacts from increased reservoir levels, and the additional flood mitigation for the downstream community. However, even with further optimisation, the implementation costs for these two options are likely to be greater than estimates<sup>3</sup> of flood damages avoided over a 50-year timespan.

Regardless of the option(s) selected for further investigation, it is also recommended that the option(s) be stress-tested using additional long-term and short-term climate sequences that are indicative of potential future conditions in the Campaspe River catchment.

---

<sup>3</sup> The extent of avoided damages varies by both the flood magnitude and option. This means that if any of the options considered were implemented, the time to recoup the costs in the form of avoided flood damages would depend on the timing and magnitude of future flooding along the Campaspe River, both of which are unknown.



# 1. Introduction

## 1.1 Project scope

This report summarises the outcomes of the technical assessment of potential operating and infrastructure options for increasing the flood mitigation provided by Lake Eppalock. The assessment was completed in two milestones, and this report covers both.

Milestone 1 included:

- A literature review of previous studies into options previously considered for increasing flood mitigation at Lake Eppalock
- A workshop with the Department of Energy, Environment and Climate Action (DEECA) and stakeholders to identify operating and infrastructure options to investigate in this study
- Modelling the anticipated changes to seasonal determinations (i.e. allocations) for water shares, and flood frequencies downstream of Lake Eppalock, if the options were implemented
- Modelling the anticipated changes the options would have made to outflows from Lake Eppalock during the 2011 and 2022 floods
- A high-level assessment of how the options would change flood frequencies at Rochester.

Milestone 2 included:

- Preparing high-level concept designs of the infrastructure upgrades required to implement the options investigated, and estimating the capital cost of the associated works
- Estimating the volume of water that may need to be recovered from the Campaspe system, to offset anticipated changes to seasonal determinations if the options were implemented
- Assessing how the daily flow regime downstream of Lake Eppalock could change under the options investigated
- Using the rapid flood risk assessment underway for the Campaspe River reach from Lake Eppalock to Rochester, and the inundation mapping available from the 2013 Rochester Flood Management Plan (Water Technology, 2013), to characterise expected changes to flood damages if the options are implemented
- Collating information regarding the potential impact that each option may have on Traditional Owner values
- Assessing the potential impacts for recreational users of Lake Eppalock and upstream landholders
- Providing commentary on how a warming climate may change the flood characteristics at Lake Eppalock and downstream, and hence the effectiveness of potential operating and infrastructure options for increasing the flood mitigation provided by the storage.

Results from this technical assessment will inform the update of the Rochester flood management plan, which is being conducted by Campaspe Shire Council with the support of the North Central Catchment Management Authority (CMA).



## 1.2 Project context

This study was commissioned by DEECA in May 2023, following the October 2022 floods in the Campaspe River basin. Information about the October 2022 floods has been summarised by Goulburn-Murray Water (GMW) on the website <http://www.g-mwater.com.au/customer-services-resources/flood-recovery/floods-in-focus-campaspe-river-system>.

Key facts from this website include that:

- Lake Eppalock has fixed crest spillways, but still reduces the peak of floods as they pass through the storage
- Lake Eppalock, which holds 304,650 ML at full supply level (FSL), was at 50% of storage capacity in early August 2022, and began spilling on September 30
- Releases from Lake Eppalock, via the outlet used to supply downstream irrigation and environmental water demands, were increased to maximum capacity on 4 October (approximately 1,600 ML/d) in anticipation of forecast rainfall
- On 8 October, inflows to Lake Eppalock were approximately 30,000 ML/d and outflows 13,000 ML/d. The inflows and outflows receded to approximately 3,000 ML/d – 4,000 ML/d by 12 October.
- On 13-14 October, inflows into and outflows from Lake Eppalock increased rapidly to peak at historical highs (approximately 235,000 ML/d and 103,000 ML/d respectively)
- Outflows from Lake Eppalock and tributary inflows from Forest Creek, Mount Pleasant Creek and Axe Creek contributed to the major Campaspe River flooding in Rochester on 14-15 October, which peaked at approximately 120,000 – 140,000 ML/d.

The October 2022 flooding through Rochester resulted in inundation of most of the properties, and the damage of more than 800 homes<sup>4</sup>.

## 1.3 This report

In this report:

- Section 2 includes information about Lake Eppalock
- Section 3 summarises the outcomes of previous relevant studies
- Section 4 describes the options assessed in this study to increase the flood mitigation provided by Lake Eppalock
- Section 5 outlines the water resource implications of the options investigated
- Section 6 summarises the expected flood frequency changes at Lake Eppalock if the options were implemented
- Section 7 includes an assessment of how the options would have potentially changed the outflows from Lake Eppalock during the January 2011 and October 2022 floods

---

<sup>4</sup><https://new.parliament.vic.gov.au/4a4c99/contentassets/1a76336c2e3d4442a850ee4dea08817d/submission-documents/650.-campaspe-shire-council.pdf>



- Section 8 includes concept designs of the infrastructure works required to implement the options investigated, and the estimated capital costs. These costs include the volumes of water that may need to be recovered from the Campaspe system, to offset anticipated changes to the reliability of supply.
- Section 9 discusses the potential impacts for recreational users of Lake Eppalock and upstream landholders
- Section 10 provides an assessment of how the daily flow regime downstream of Lake Eppalock could change under the options investigated, and the potential impacts on known Traditional Owner values
- Section 11 includes information on potential flood frequency changes at Rochester, and the associated flood damages
- Section 12 provides some concluding remarks, including comments on the further work that would be required to progress options beyond the concepts considered in this report.

Additional information is included in the appendices, including drawings of the current dam arrangements (Appendix A), a summary of options which were considered but initially assessed as unlikely to provide additional flood mitigation (Appendix B), extra drawings for the infrastructure options assessed (Appendix C), a description of the method used to estimate flood damages (Appendix D) and commentary on expected future climate change impacts (Appendix E).

## 1.4 Models used

This assessment of potential operating and infrastructure options for increasing the flood mitigation provided by Lake Eppalock was informed by applying several existing models:

- The Goulburn Simulation Model (GSM), which is owned by DEECA, was used to assess the water resource implications of the options investigated. The 'base case' version available for this study simulates the period from July 1891 to June 2022 on a monthly time-step, and represents the application of current infrastructure and system operation rules under long-term historic climate conditions, with consumptive and environmental water demands as per Victoria's water resource plans<sup>5</sup>. More detail on the GSM is included in Section 5.1.
- The RORB model of the Lake Eppalock catchment and dam, which is owned by GMW, was applied to simulate how the options would change flood frequencies immediately downstream of the storage. The RORB model was first developed by SKM (1998) and was last updated by HARC (2017). It simulates runoff from rainfall events ranging in burst durations from 12 hours to 168 hours. The RORB model was also used to assess how the options may have changed the January 2011 flood outflows if they were in place. Refer to Section 6 and Section 7 for more detail.

---

<sup>5</sup> <https://www.water.vic.gov.au/our-programs/murray-darling-basin/water-resource-plans>



- The Stochastic Goulburn Environmental Flow Model (SGEFM), developed by the University of Melbourne (John, 2021), was used to investigate expected changes to the daily flow regime downstream of Lake Eppalock. The SGEFM simulates the distribution of water resources at a monthly time-step – as does the GSM – but then disaggregates the results to a daily time-step using anticipated reservoir release patterns and streamflow patterns derived from historic gauge records of tributary flows. More detail on the SGEFM is included in Section 10.2.

Given the time available for this study, these existing models were used as available. They are fit-for-purpose for this technical assessment, as demonstrated in the sections referenced in the dot-points above, when used to make high-level comparisons between current conditions (i.e. the base case) and what is anticipated if the options were implemented. But although the relative differences between options are not expected to change significantly as further investigations are completed, specific values quoted in this report will become superseded:

- When the DEECA daily Goulburn-Broken-Campaspe-Coliban-Loddon Source model replaces the GSM in the near future
- When the RORB model of the Lake Eppalock catchment is re-calibrated using the October 2022 flood records
- If any of the potential operating and infrastructure options for increasing the flood mitigation provided by Lake Eppalock is simulated using the hydrology and hydraulic models that are being applied to update the Rochester flood management plan.

## 1.5 Terminology

In this report, for simplicity the term FSL has been used to refer to the full supply level and the volume of water held in storage when the reservoir is at FSL. Therefore, terms such as 50%, 70% or 90% of FSL refer to the volume of water held in storage (i.e. 50%, 70% or 90% of the volume stored when Lake Eppalock is at FSL), rather than 50%, 70% or 90% of the full supply level measured in m AHD.



## 2. Lake Eppalock

The information in this section of the report is paraphrased from reports by SKM (2012a) and HARC (2017).

### 2.1 Storage information

Lake Eppalock was constructed between 1960 and 1964 to store water for consumptive use. The FSL is 193.91 m AHD, at which 304,650 ML (304.65 GL) is held in storage. This capacity is shared 82% : 18% between GMW and Coliban Water respectively. The main embankment at Lake Eppalock consists of a central clay core and dumped rockfill shoulders separated by filter layers. The ‘short’ and ‘long’ secondary embankments are of similar earth and rockfill construction.

Lake Eppalock has three overflow spillways set at different crest levels. The main spillway cuts through a basalt capped promontory near the left abutment of the main dam, and consists of a curved ogee crest weir, a concrete lined converging chute and a short stilling basin. The approach channel is crossed by a road bridge. East of the main dam is the secondary spillway which discharges over a 200 m long ogee crest weir into a gully. The tertiary spillway to the west of the main dam consists of a gully with the crest formed by Spillway Road. This spillway overflows into Mosquito Creek, a tributary of the Campaspe River.

Drawings of the general dam arrangements are provided in Appendix A, and key aspects of the embankments and spillways are summarised in Table 6.

Table 6: Key aspects of the spillways and embankments at Lake Eppalock

Component (reference)	Value
Primary spillway crest level (SKM, 2012b)	193.91 m AHD
Primary spillway crest length (SKM, 2012b)	76 m
Secondary spillway crest level (SKM, 2012b)	195.74 m AHD
Secondary spillway crest length (SKM, 2012b)	198 m (approximate)
Tertiary spillway crest level (SKM, 2012b)	197.57 m AHD
Tertiary spillway crest length (SKM, 2012b)	361 m (approximate)
Short bank crest level (SKM, 2000)	199.27 m AHD (min); 199.49 m AHD (mean)
Short bank crest length (SKM, 2000)	356 m
Long bank crest level (URS, 2007; SKM, 2005)	199.60 m AHD
Long bank crest length (SKM, 2000)	1432 m
Main embankment crest level (SKM, 2000)	199.77 m AHD (min); 199.86 m AHD (mean)
Main embankment crest length (SKM, 2000)	600 m
Natural embankment height between main embankment and tertiary spillway (SKM, 2000)	200.02 m AHD (min); 201.10 m AHD (mean)
Natural embankment length (SKM, 2000)	260 m (approximate)



The water stored at Lake Eppalock is used to supply private diverters (irrigators), meet environmental water demands along the Campaspe River, underpin urban water security for Bendigo and a number of other towns, and meet trade commitments to the River Murray. In years when there is sufficient water available in the Campaspe system, Lake Eppalock is also used to supplement the Waranga Western Channel, which supplies water to the Rochester and Pyramid-Boort irrigation areas. This sharing of the stored water is governed by the Bulk Entitlement (Campaspe System – Goulburn-Murray Water) Conversion Order 2000, and historical water availability and use in the Campaspe system is tracked on the Victorian Water Register<sup>6</sup>.

The outlet works at Lake Eppalock consist of a cylindrical concrete outlet tower which leads over a transition culvert to a concrete lined pressure tunnel. Inlet ports in the tower can be opened and closed to draw off water at different reservoir levels. The maximum capacity of this outlet is approximately 1,600 ML/d when the reservoir is at FSL.

The energy available in the water released from Lake Eppalock can be used to drive hydraulic turbines coupled to high-head pumps (Heitlinger et al., 1965). However, one of the three turbines has been removed and it has been a number of years since the others were operated (SKM, 2012a). Instead, the pumping of water from Lake Eppalock to Bendigo is powered by electric motors installed by Coliban Water. For water to be pumped by the hydraulic turbines, the turbines would need to be recommissioned. The volumes pumped from Lake Eppalock are determined by Coliban Water's need for the water, and the airspace in their storages.

## 2.2 Catchment details

The Lake Eppalock catchment encompasses an area of approximately 2,028 km<sup>2</sup>. Two major tributaries flow into the storage; the Campaspe River and the Coliban River (Figure 8). Several smaller tributaries also provide inflow to the storage.

The Campaspe River upstream of Lake Eppalock is an unregulated waterway, whereas the Coliban River is regulated; i.e., there are three storages managed by Coliban Water in the upper reaches. These storages have a total catchment area of approximately 306 km<sup>2</sup> and harvest flow generated from the upper Coliban River catchment. When the storages are not spilling, only the passing flow and inflow to the Coliban River downstream of the dams can reach Lake Eppalock. However, if the upper Coliban storages are at or near capacity, smaller volumes of inflows are harvested, and the remainder are passed downstream to Lake Eppalock.

The catchment area of the Campaspe River between Lake Eppalock and Rochester (i.e. downstream of Lake Eppalock) is approximately 1,370 km<sup>2</sup>. There are two main tributaries in this reach between Lake Eppalock and Rochester; Axe Creek (catchment area 234 km<sup>2</sup>) and Mount Pleasant Creek (catchment area 248 km<sup>2</sup>).

---

<sup>6</sup> <https://www.waterregister.vic.gov.au/water-availability-and-use/available-water-by-owner-type>



Operating and infrastructure options for increasing flood mitigation at Lake Eppalock

Technical assessment report

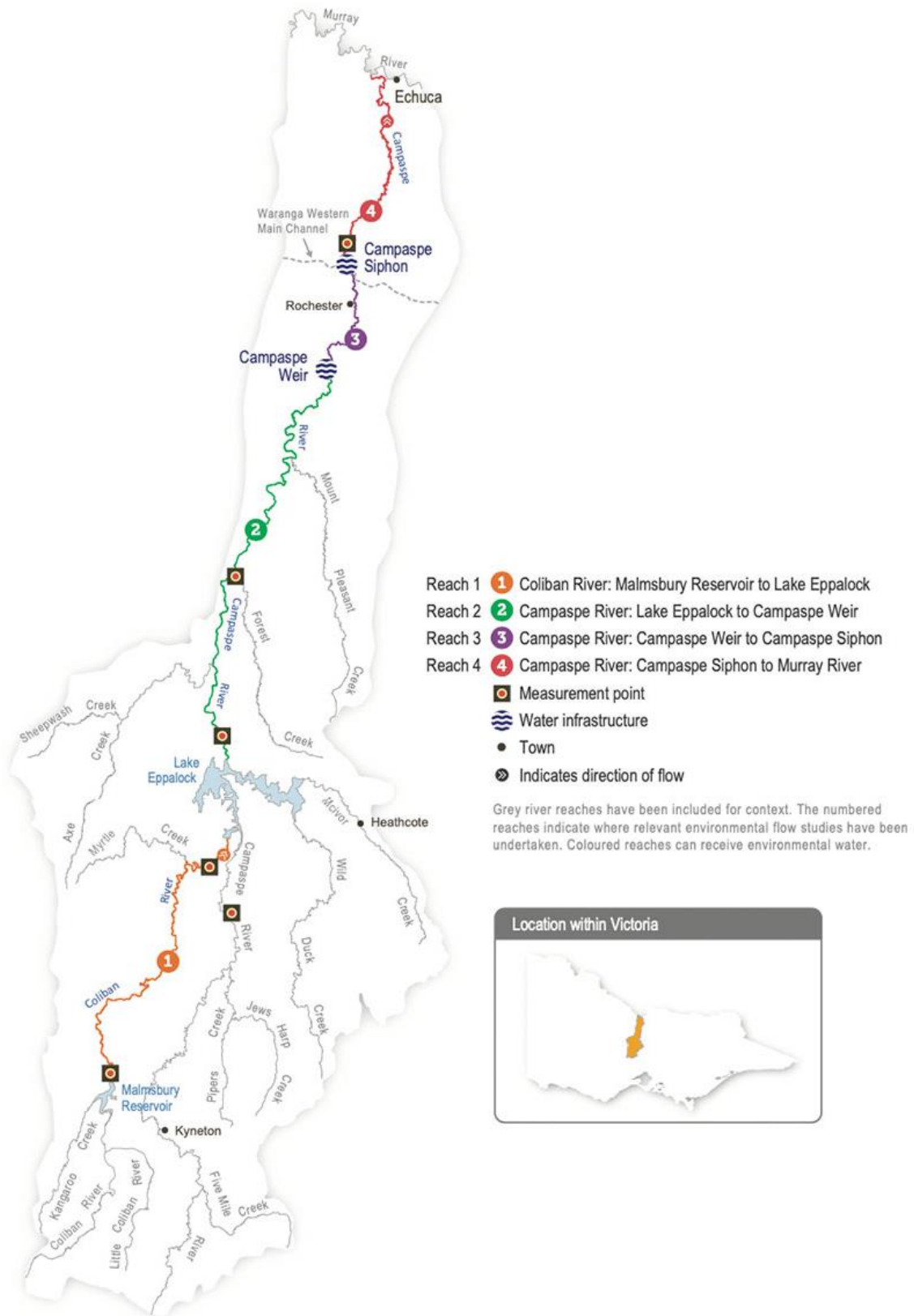

Figure 8: Campaspe River basin  
<https://www.vewh.vic.gov.au/rivers-and-wetlands/northern-region/campaspe-river>



## 2.3 Historic storage behaviour

Figure 9 shows the recorded volume stored at Lake Eppalock from June 1962 until April 2023. Also shown are the historic spills from storage over the same period, and how these have compared with minor flood, moderate flood and major flood thresholds defined for the Campaspe River at Eppalock (20,180 ML/d, 43,410 ML/d and 78,150 ML/d respectively)<sup>7</sup>.

Based on Figure 9, the following observations can be made –

The storage and spill behaviour at Lake Eppalock from the mid-1990s onwards has been distinctly different compared with the period from the mid-1960s to mid-1990s. Before the mid-1990s, Lake Eppalock filled and spilled most years, and was rarely drawn down below 50% of FSL (approximately 150,000 ML). Spills were typically below or slightly above the minor flood threshold at Eppalock.

Since the mid-1990s, the Lake Eppalock storage trace has typically been lower and for longer periods of time compared with the earlier period. The frequency of spills from storage has therefore reduced. However, two of the spills (January 2011 and October 2022) are by far the largest in the historic record, even though in the months beforehand the reservoir was at 50% or less of FSL.

---

<sup>7</sup> Flood class thresholds provided by GMW, based on data for gauge 406207 from [http://www.bom.gov.au/vic/flood/floodclass\\_north.shtml](http://www.bom.gov.au/vic/flood/floodclass_north.shtml) and <https://data.water.vic.gov.au/>

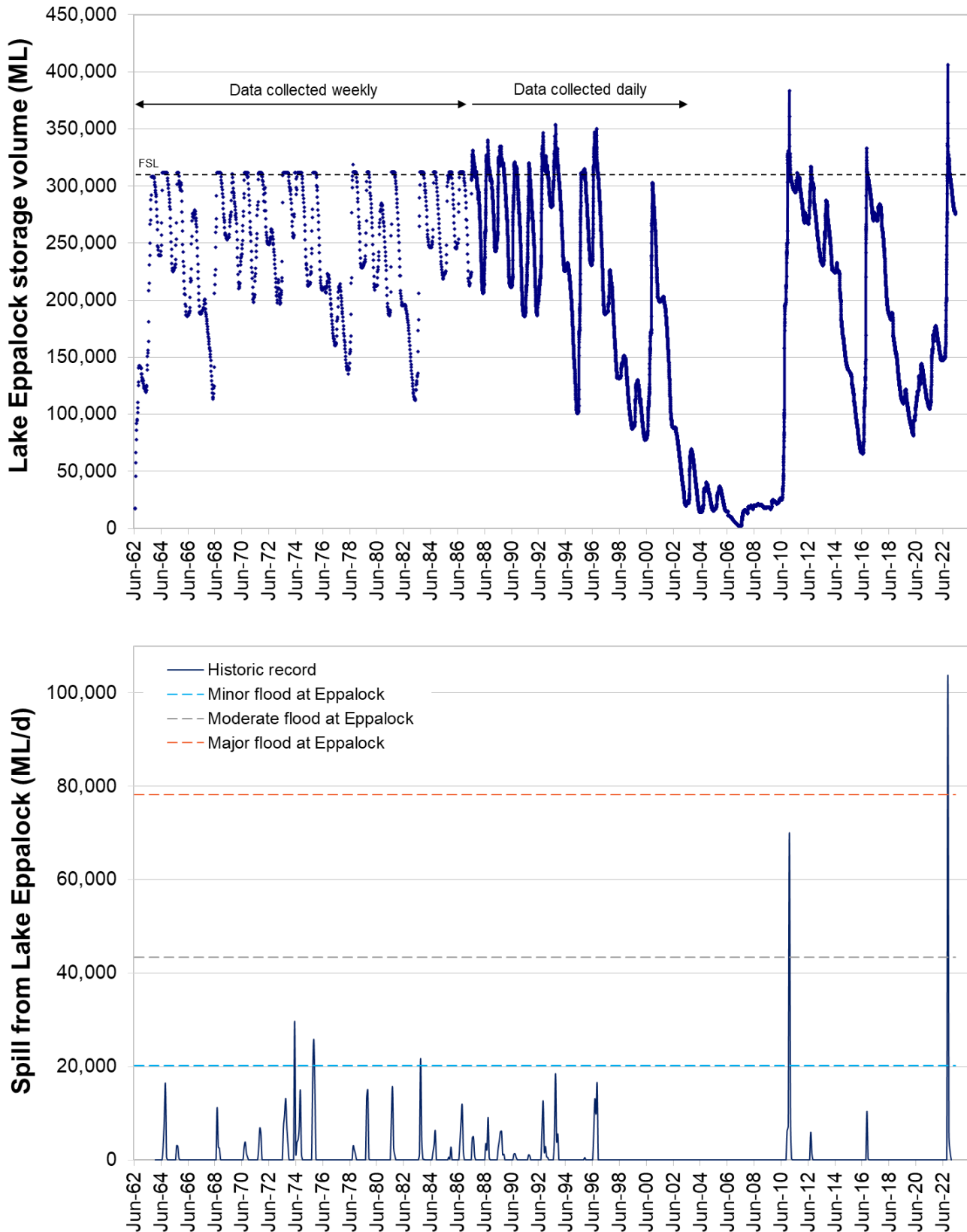

Figure 9: Recorded storage volumes (top) and spills from Lake Eppalock (bottom) for the period from June 1962 to April 2023. Data supplied by GMW.



## 2.4 Influence on Rochester floods

For July to June water years post-1975, Figure 10 compares the peak spill from Lake Eppalock with the peak flow recorded at the Rochester syphon (gauge 406202), both as a time-series (top) and x-y scatter plot (bottom). The period post-1975 has been chosen for this comparison because it is more representative of current climate conditions in Victoria compared with pre-1975<sup>8</sup>.

Figure 10 demonstrates that over the post-1975 record there is a strong correlation between the peak spill from Lake Eppalock and the peak flow at Rochester, with the peak flow at Rochester typically being 1.2 to 3.3 times the peak spill from Lake Eppalock. Therefore, if the flood mitigation provided by Lake Eppalock can be increased, it would be expected that flood frequencies in Rochester would decrease.

However, the correlation between Lake Eppalock spills and flooding in Rochester is not perfect. For example, in 1983/84 and 1992/93 the peak flow at Rochester was near or above the major flood threshold for gauge 406202 (51,300 ML/d<sup>9</sup>), when the peak spill from Lake Eppalock was near or below the minor flood class at Eppalock. This is possible because of the large catchment area (~1,370 km<sup>2</sup>) and the tributaries of the Campaspe River between Lake Eppalock and Rochester. That is, if rainfall is heaviest in the region downstream of the dam rather than upstream, significant flooding at Rochester can occur even if there is minimal flooding at Lake Eppalock.

Figure 10 also shows that historically most spills from Lake Eppalock have been below the minor flood threshold for the Campaspe River at Eppalock, and the corresponding water year peak at the Rochester syphon has been near or below the moderate flood threshold. The three years when peak spills from Lake Eppalock were greater than 20,000 ML/d have coincided with years where flooding in Rochester has been above the major flood threshold. Further details on what minor, moderate and major flooding in Rochester represents in terms of areas inundated is provided in Section 11.1.

---

<sup>8</sup> <https://www.water.vic.gov.au/climate-change/adaptation/guidelines>

<sup>9</sup> [http://www.bom.gov.au/vic/flood/floodclass\\_north.shtml](http://www.bom.gov.au/vic/flood/floodclass_north.shtml) and <https://data.water.vic.gov.au/>

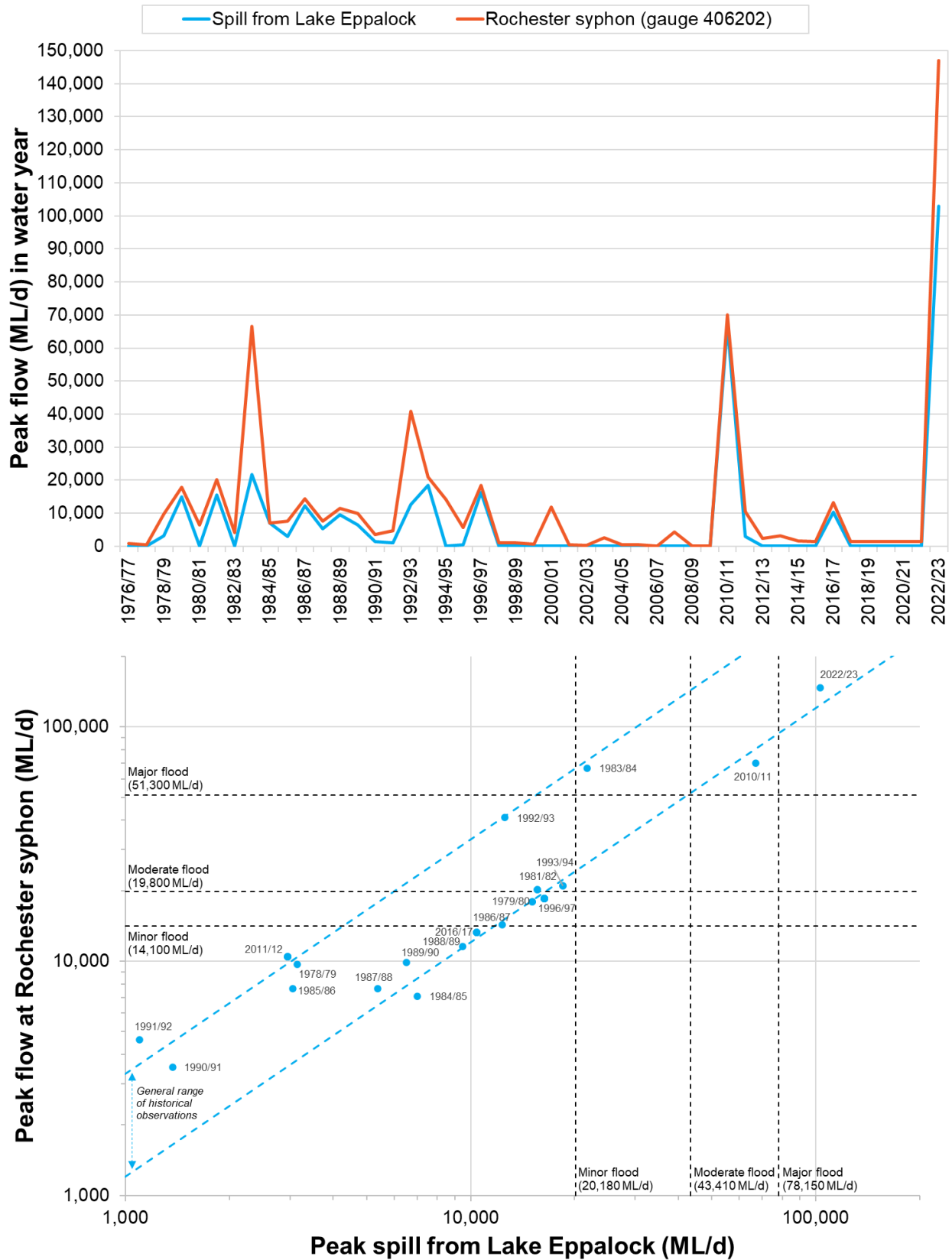

Figure 10: Peak spills from Lake Eppalock versus peak flows at the Rochester syphon for each water year post-1975, shown as a time-series (top) and x-y scatter plot (bottom)



### 3. Previous studies

Before considering options to increase the flood mitigation provided by Lake Eppalock, several previous studies were reviewed. These were:

- State Rivers and Water Supply Commission. (1947). Utilization of the Waters of the Campaspe River. Eppalock Reservoir Enlargement. General Report.
- State Rivers and Water Supply Commission. (1959). Utilization of the Waters of the Campaspe River. Eppalock Reservoir Enlargement.
- State Rivers and Water Supply Commission. (1974). Enlargement of Eppalock Reservoir.
- SKM. (2012a). Filling Curve Options for Lake Eppalock. Report prepared for GWM.
- Water Technology. (2013). Rochester Flood Management Plan. Report prepared for North Central Catchment Management Authority and Campaspe Shire Council.
- Water Technology. (2018). Rochester Mitigation Study. Report prepared for Campaspe Shire Council.

The outcomes of these studies are summarised below.

#### 3.1 State Rivers and Water Supply Commission (1947)

As early as 1885, a reservoir on the Campaspe River was proposed. However, it was not until 1930 that the construction of Eppalock Dam commenced. Works then ceased in 1933 after £152,000 had been spent, with the dam only impounding 1,200 acre-feet (1,500 ML). In 1935, the Parliamentary Public Works Committee advised against the completion of the proposed works, given the expected high cost.

Enlargement of the dam was further investigated in 1947. Extensions works to form a 250,000 acre-feet (308,000 ML) reservoir were proposed. The spillway design included eight vertical-lift gates, and the stored water would be used for irrigation in the Campaspe District, domestic and stock supply in the Elmore-Warragamba area, and the generation of electricity.

#### 3.2 State Rivers and Water Supply Commission (1959)

After the 1947 proposal to enlarge Lake Eppalock failed to gain momentum, an enlargement was again proposed in 1959, but with some alterations. The same storage size was recommended; however, three fixed crest spillways were proposed instead of a single gated spillway (Appendix A). The primary spillway, on the left bank, was designed to take previously recorded floods, while the secondary spillway, on the right bank, was designed to take higher flows. The tertiary spillway was designed to operate during very rare floods, and was placed away from the dam to discharge into Mosquito Creek.

This spillway arrangement was considered economical, because the primary spillway would not need to be constructed to pass all floodwaters. The additional spillways would also rarely be used, and therefore could be constructed relatively cheaply.



Another key difference between the 1947 and 1959 proposals was the use of the stored water. The 1959 version proposed that the water would be used by irrigators downstream of the dam, and by irrigators and urban centres in the Coliban System (Bendigo, Castlemaine, etc.).

It was also noted in the State Rivers and Water Supply Commission (1959) report that the reservoir enlargement would increase the flood mitigation provided by the dam. For ten of the largest flows recorded at Rochester to that time, it was estimated that the enlargement of Lake Eppalock would have prevented downstream flooding in three cases, and in the remaining seven, flows would have been reduced by 50% at Eppalock and 40% at Elmore and Rochester.

The 1959 proposal was successful, and the enlarged Eppalock Dam was constructed between 1960 and 1964.

### 3.3 State Rivers and Water Supply Commission (1974)

A preliminary investigation into raising the FSL at Lake Eppalock by up to 1.83 m – to increase the volume of water stored for consumptive use – was conducted in 1974. As part of this investigation, the effect of multiple spillway arrangements on flood levels within and downstream of Lake Eppalock was assessed. These arrangements were:

- Raising the fixed crests of the primary and secondary spillways
- Adding gates to the primary spillway
- Adding gates to the primary spillway, and raising the fixed crest of the secondary spillway
- Adding gates to the primary spillway, and raising the secondary spillway using an erodible crest
- Lowering the primary spillway and adding gates, and raising the secondary spillway using an erodible crest.

In this investigation the focus for the spillway arrangements was on reducing increases in reservoir levels during floods – so that the proposed raise of FSL did not unduly compromise dam safety – rather than mitigating downstream flooding. Therefore, apart from the first option, the options if implemented were expected to increase the outflows from Lake Eppalock, by reducing or eliminating flood mitigation for events with annual exceedance probability (AEP) of 1 in 100 or more frequent.

The conclusion of the investigation was that raising the FSL at Lake Eppalock was technically feasible, but that costs were likely to outweigh benefits. The disadvantages associated with the operation and maintenance of spillway gates were also noted.

### 3.4 SKM (2012a)

After the January 2011 floods in northern Victoria, GMW commissioned SKM to investigate whether the adoption of filling curves at Lake Eppalock would potentially increase the flood mitigation provided by the storage. Adopting a filling curve would involve using the downstream outlet to control the reservoir level – to the degree possible – to follow a defined storage trace rather than allowing the storage to fill at the earliest opportunity.



Figure 11 shows the three filling curves investigated. A case where the storage was held at or below a target of 70% of FSL was also assessed.

Figure 12 summarises the modelled change to the frequency of peak outflows from Lake Eppalock for the four options investigated. Using a filling curve at Lake Eppalock was predicted to make a marginal difference to downstream flood frequencies. Additionally, the 2011 flood would have been unaffected by a filling curve, given it occurred in January. In contrast, introducing a target storage of 70% would reduce the frequency of floods. However, it would also reduce the reliability of supply to entitlement holders, with the proportion of years where full allocations can be supplied decreasing from 93% to 89% for high-reliability water shares (HRWS), and from 74% to 45% for low-reliability water shares (LRWS).



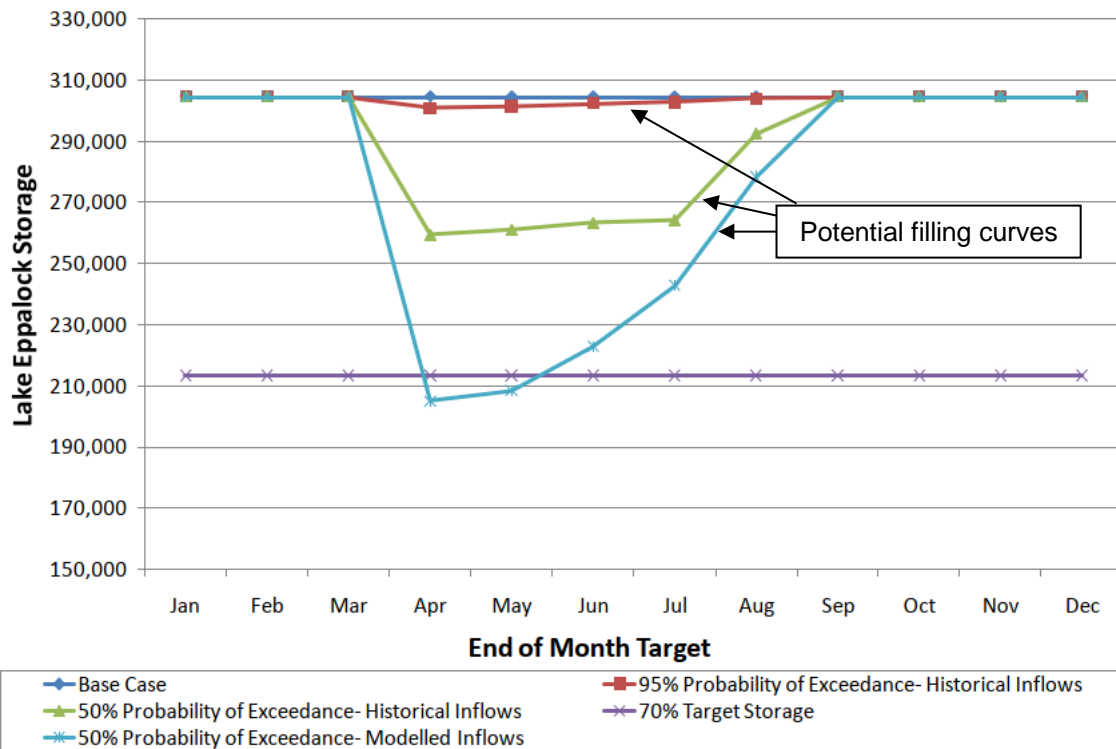

Figure 11: The different options investigated by SKM (2012a) as potential ways to increase the flood mitigation provided by Lake Eppalock. Historic inflows are those recorded by GMW since construction in the 1960s, and modelled inflows are those included in the Goulburn Simulation Model (GSM) for the period 1891 to date.

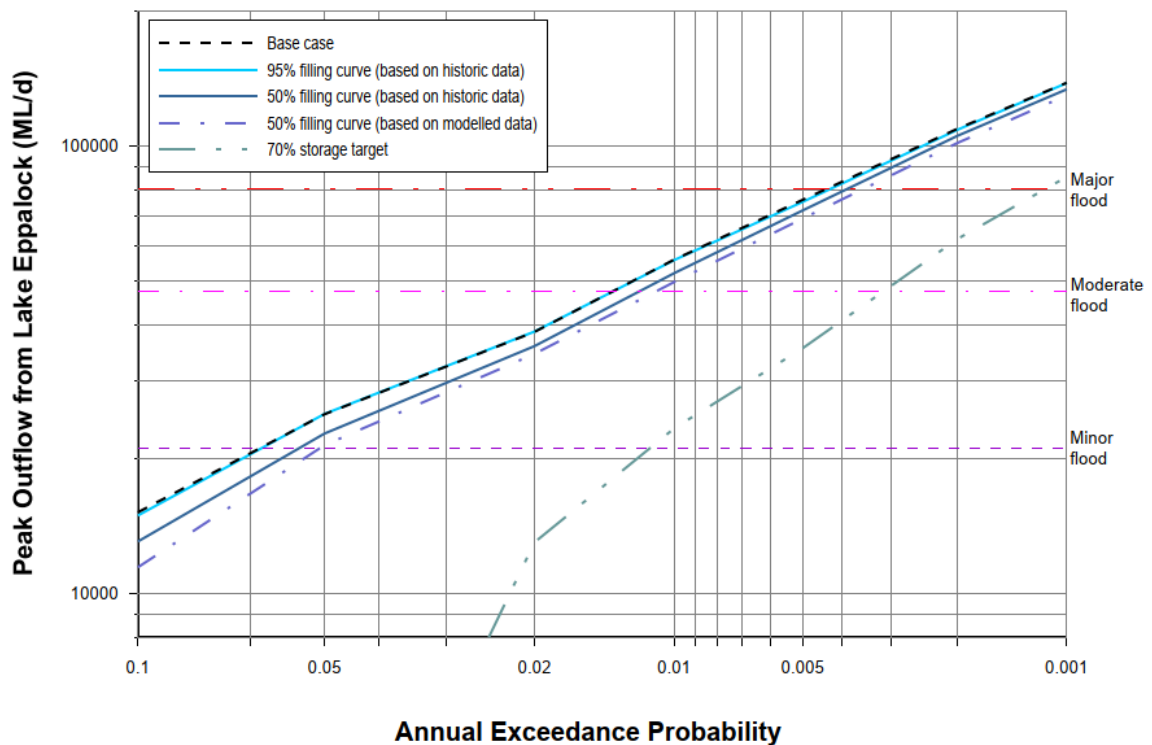

Figure 12: The changes in flood frequency associated with the investigated measures, as reported by SKM (2012a)



### 3.5 Water Technology (2013 & 2018)

After the 2011 floods, the Rochester Flood Management Plan was also updated by Water Technology (2013) for the North Central CMA and Campaspe Shire Council. The 2013 plan involved an assessment of flood mitigation options, and recommended the following:

- Implementation of a flood warning system at Rochester
- Detailed design of a levee to replace irrigation channel 1/1
- An update of the planning scheme to incorporate the latest flood overlays
- Further investigation of potential flood mitigation options, including other levee and drainage works.

The last of these recommendations was addressed by the Rochester Mitigation Study (Water Technology, 2018). This study concluded that the only flood mitigation options likely to be feasible were floor raising and an 'eastern drainage line mitigation scheme' (Figure 13), with the latter option considered more feasible. However, this scheme only received support from 35% of the community surveyed. Community comments showed a desire to see local drains, flood warning and sandbagging improved, as well as additional regulation of reservoir levels at Lake Eppalock to increase flood mitigation.

The flood management plan for Rochester is being updated, and will consider a range of potential flood mitigation options. Outcomes from this assessment of the potential operating and infrastructure options for increasing the flood mitigation provided by Lake Eppalock will inform the update of the Rochester flood management plan.

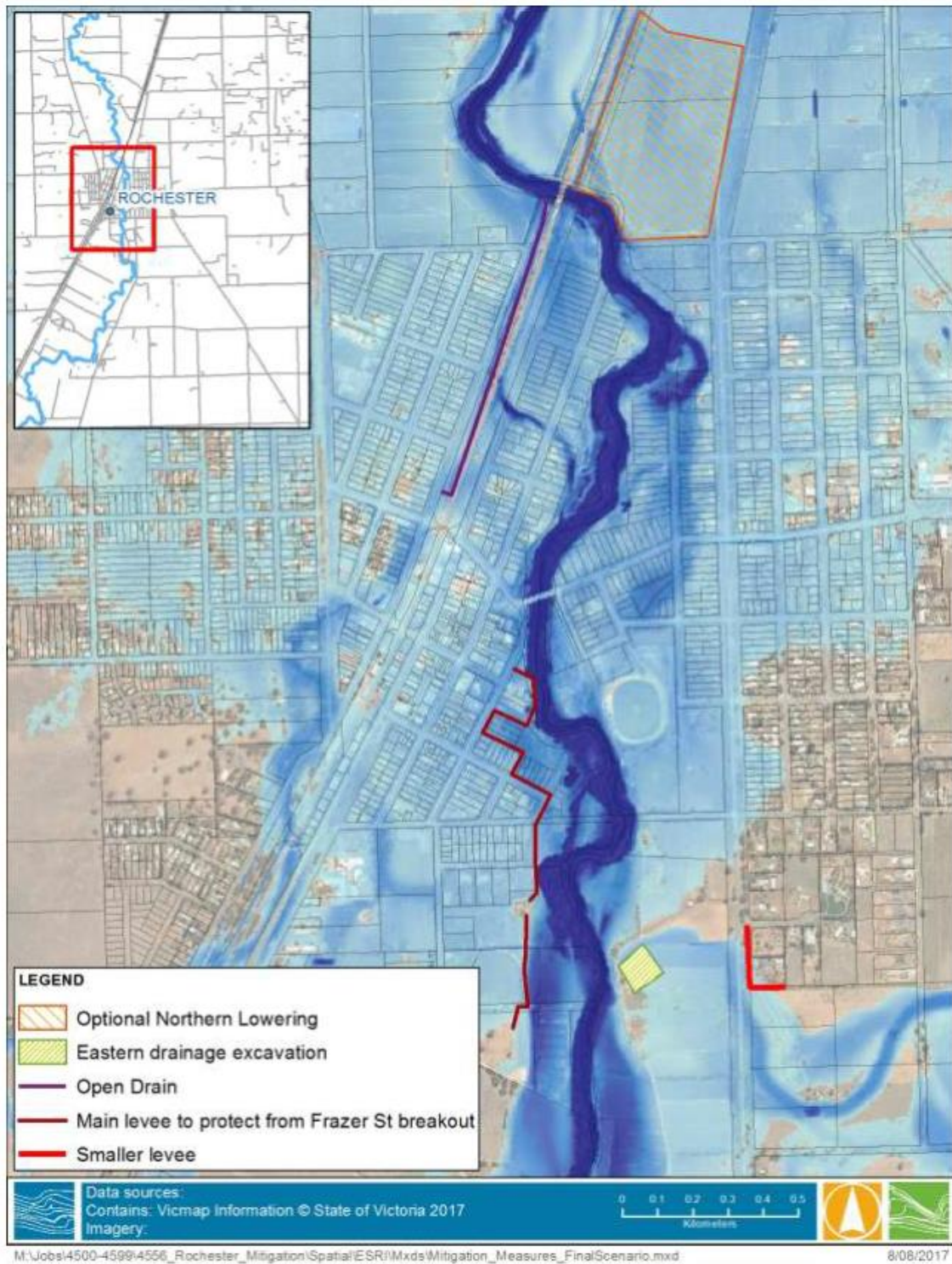

Figure 13: A plan view of works associated with the 'eastern drainage line mitigation scheme' for Rochester, as described in the Rochester flood mitigation study (Water Technology, 2018; Figure 8-1). The modelled water depths (in blue) provide an indication of expected flooding through Rochester during the 1% AEP event, as simulated by Water Technology, under existing conditions.



### 3.6 HARC (2017 & 2019)

The most recent reviews of the spillway adequacy and dam safety of Lake Eppalock were completed by HARC in:

- March 2017: *GMW Dams PRA Hydrology Review; Lake Eppalock*
- September 2019: *GMW Dams PRA Project; Risk Assessment: Lake Eppalock*

The conclusion of these studies was that the individual and societal risks posed by Lake Eppalock were well below the ANCOLD (2003) limit of tolerability for existing dams. In addition, the 2019 risk assessment did not identify any potential major upgrades that would be likely to significantly reduce the already low dam safety risks associated with Lake Eppalock.

Outputs from these 2017 and 2019 studies have been used in this assessment of the potential operating and infrastructure options for increasing the flood mitigation provided by Lake Eppalock. In particular:

- The flood hydrology (RORB) rainfall-runoff model of the catchment updated in 2017 informs the assessment of expected flood frequency changes at Lake Eppalock (Section 6).
- The dam safety risk assessment informs the concept design and high-level costings of the options (Section 8).



## 4. Options investigated

### 4.1 Selection method

A workshop with DEECA, GMW, Coliban Water, Central Highlands Water (CHW), the Victorian Environmental Water Holder (VEWH), the North Central CMA, Bendigo City Council and Campaspe Shire Council was held in Bendigo, on June 7<sup>th</sup> 2023, to discuss potential operating and infrastructure options for increasing the flood mitigation provided by Lake Eppalock.

Based on the outcomes from this workshop, five options for increasing the flood mitigation provided by Lake Eppalock were selected for further investigation. The options are briefly described in the report sub-sections below, along with a subjective rating against the seven elements that were considered when selecting the five options. These elements were:

- **Potential to reduce the peak outflow from Lake Eppalock**  
i.e., the expected effect the option would have on flood peaks immediately downstream of Lake Eppalock (e.g. by providing additional airspace for flood storage, or by throttling flows through the spillways)
- **Reduced reliability of supply for entitlement holders**  
i.e., the expected reduction in the reliability of supply to entitlement holders in the Campaspe system
- **Constructability**  
i.e., how difficult it would be to construct the works without compromising dam safety
- **Capital cost of works<sup>10</sup>**  
i.e., how relatively expensive the works would be to design and construct
- **Operational risk**  
i.e., the relative degree to which implementing the option would increase the risks borne by storage operators between or during flood events (e.g. unnecessarily releasing water from storage or exacerbating downstream flooding)
- **Environmental impact**  
i.e., the potential impact to environmental assets and known Traditional Owner values at Lake Eppalock, and along the Campaspe River downstream
- **Recreational impact**  
i.e., the potential impact to recreational activities around Lake Eppalock

Other options considered during the workshop or later stages of the project are summarised in Appendix B. The subjective ratings and text in Appendix B explain why these other options were not selected for more detailed assessment.

---

<sup>10</sup> Not including any potential costs associated with mitigating changes to reliability of supply for entitlement holders, or additional operations and maintenance costs



## 4.2 Reduce target storage

This option involves using the outlet for downstream releases to hold the storage – to the degree possible – below or at a targeted proportion of FSL (e.g. 70%), rather than allowing Lake Eppalock to fill to FSL. The additional airspace in Lake Eppalock would further reduce flood peaks as events passed through the storage.

This option was also considered by SKM in 2011, and the SKM found that adopting a target storage of 70% of FSL would reduce peak outflow frequencies at Lake Eppalock, but also reduce the reliability of HRWS and LRWS held in the Campaspe system. Having a target storage at Lake Eppalock below FSL would also impact recreational users and tourism facilities (e.g. boating, holiday parks) by reducing the depth and extent of the waterbody.

The degree to which this option would reduce peak outflows from Lake Eppalock would vary by event (Table 7) because of the relatively limited downstream outlet capacity. For example, if a major flood was preceded by periods of inflows to Lake Eppalock > 1,600 ML/d, it would not be possible to keep the reservoir level at or below the target storage before the flood arrived (see Section 7.2.1 for more detail). Therefore, the next option considered (Section 4.3) includes both a reduced target storage and increased outlet capacity.

Table 7: Subjective ratings for the option to reduce the Lake Eppalock target storage

Element	Subjective Rating
Potential to reduce peak outflow from Eppalock	Low – High
Reduced reliability of supply	High
Constructability	N/A
Capital cost of works	N/A
Operational risk	Low – Medium
Environmental impact	Low – Medium
Recreational impact	Medium – High

## 4.3 Reduce target storage and increase outlet capacity

This option (Table 8) involves reducing the target storage at Lake Eppalock (Section 4.2), and increasing the downstream outlet capacity so that operators have greater ability to release water from storage during intervals between floods. To implement this option, a second downstream outlet would be required at Lake Eppalock, because of the anticipated dam safety risks associated with expanding the existing outlet. Increasing the outlet capacity at Lake Eppalock would also have the benefit of providing environmental water managers with greater flexibility to deliver winter freshes and bankfull events to the Campaspe River.

For this investigation, an outlet capacity of 5,000 ML/d was selected. A total release of 5,000 ML/d from Lake Eppalock is likely to be below thresholds that may cause flooding at Rochester (Figure 10), the additional 3,400 ML/d outlet capacity would be sufficient to deliver the 1,800 – 2,000 ML/d winter freshes recommended for the Campaspe River downstream of



Lake Eppalock<sup>11</sup>, and this outlet capacity would have been sufficient to hold Lake Eppalock at a target storage below FSL in the lead-up to the 2011 and 2022 floods (Figure 42). However, further optimisation of the increased outlet capacity and the associated cost, flood mitigation potential and operational benefits would be required before this option was implemented.

At Lake Eppalock there is also three hydraulic turbines, one of which is used as a pump station by Coliban Water to transfer water to Bendigo. If the two unused turbines were recommissioned or retrofitted, there may be the opportunity to release a further 400 ML/d – 500 ML/d downstream of Lake Eppalock using the existing infrastructure, in addition to the 1,600 ML/d that can be passed through the butterfly valve on the downstream outlet (GMW, pers. comm. 2022). The works required to recommission or retrofit the turbines have not been explored in detail, given the option to increase the outlet capacity is already considering an increase from 1,600 ML/d to 5,000 ML/d. However, if the option to reduce the Lake Eppalock target storage and increase the outlet capacity is found to be worth pursuing, use of the turbines may be another method by which the outlet capacity can be raised.

Table 8: Subjective ratings for the option to reduce the Lake Eppalock target storage, and increase the downstream outlet capacity

Element	Subjective Rating
Potential to reduce peak outflow from Eppalock	Medium – High
Reduced reliability of supply	High
Constructability	Difficult
Capital cost of works	High
Operational risk	Low – Medium
Environmental impact	Low
Recreational impact	Medium – High

#### 4.4 Reduce full supply level using a spillway slot

Regardless of the size of outlet works at Lake Eppalock, floods may be preceded by periods of inflows greater than the downstream outlet capacity, meaning the reservoir level cannot be held at the target storage before the flood arrives. The permanent reduction of the FSL at Lake Eppalock (Table 9) was therefore considered as an alternative method of reducing the volume held in storage prior to a flood.

The option to lower FSL at Lake Eppalock involves creating a slot in the primary spillway. Installing a passive spillway slot would also reduce peak flows from the storage during events when only the slot rather than the full primary spillway width is operating.

<sup>11</sup> <https://www.water.vic.gov.au/waterways/water-for-the-environment/how-we-manage-water-for-the-environment/environmental-water-management-plans>



Similar spillway arrangements have been installed at Hinze Dam<sup>12</sup> and South Para Dam<sup>13</sup>, and a slot spillway is part of the proposed spillway gate removal and dam safety upgrade at Mt Bold Dam<sup>14</sup>.

Table 9: Subjective ratings for the option to reduce the Lake Eppalock FSL via a passive slot spillway

Element	Subjective Rating
Potential to reduce peak outflow from Eppalock	High
Reduced reliability of supply	High
Constructability	Difficult
Capital cost of works	Medium
Operational risk	Low
Environmental impact	Low
Recreational impact	Medium – High

## 4.5 Add spillway gates

The three options above all reduce the water stored in Lake Eppalock for entitlement holders. In contrast, this option involves adding spillway gates to the primary spillway, and maintaining FSL at the existing level (Table 10).

The addition of spillway gates at Lake Eppalock would allow the storage operators to reduce peak outflows during floods by surcharging the reservoir to levels higher than would otherwise occur with a fixed crest spillway. However, surcharging the reservoir during floods would increase the number of recreational and commercial tourism sites around Lake Eppalock that are inundated compared with current conditions.

Adding spillway gates to Lake Eppalock would be a difficult and costly exercise, in general, and particularly because the primary spillway is curved in plan (Rural Water Commission, 1973). The operational risks for the owners of gated storages are also well-demonstrated by the Brisbane flood class action against Seqwater, Sunwater and the State of Queensland following floods in 2011<sup>15</sup>. In 2019, a NSW court found that the Queensland government, Sunwater and Seqwater were responsible for releasing water via the Wivenhoe Dam spillway gates too late given the rainfall forecasts available, thus increasing the floodwaters and hence damages downstream. But Seqwater successfully appealed in 2021, which led to the halving of compensation costs owing to affected residents from \$880 million to \$440 million. The personal impact on those who were operating the Wivenhoe Dam at the time was also significant (Ayre et al., 2023).

<sup>12</sup> <https://www.seqwater.com.au/sites/default/files/2019-09/2017%20Hinze%20Dam%20Downstream%20InfoSheet.pdf>

<sup>13</sup> <https://www.sawater.com.au/news/sustained-spring-rain-sees-south-para-spillway-in-action>

<sup>14</sup> <https://watertalks.sawater.com.au/mount-bold-dam-safety-upgrade>

<sup>15</sup> <https://www.caselaw.nsw.gov.au/decision/54a63ffa3004de94513dc86b>



Table 10: Subjective ratings for the option to add gates to the primary spillway at Lake Eppalock

Element	Subjective Rating
Potential to reduce peak outflow from Eppalock	Medium – High
Reduced reliability of supply	Low
Constructability	Very Difficult
Capital cost of works	Very High
Operational risk	High
Environmental impact	Low
Recreational impact	Low – Medium

## 4.6 Reconfigure spillways

The last option selected for assessment was reconfiguring the primary, secondary and tertiary spillways – without reducing FSL or adding spillway gates – so that more storage at Lake Eppalock is utilised during floods. The method selected for investigation was the installation of a piano key spillway configuration on part of the primary spillway and all of the secondary spillway. A piano key spillway was added to Loombah Dam in north-east Victoria in 2013<sup>16</sup>.

A piano key configuration increases the effective width of a spillway. By adding piano keys either side of the central portion of the primary spillway, a slot could be created through which Lake Eppalock outflows below a given threshold would be ‘throttled’. Once flows were above this threshold the keys would engage to increase the spillway flow and thus ensure dam safety is not compromised. Piano keys would also be required on the secondary spillway, and an erodible crest raise on the tertiary spillway, so that the frequency at which these emergency spillways are operating does not increase despite the changes to the primary spillway.



Figure 14: An example of a piano key spillway<sup>17</sup>

<sup>16</sup> <https://www.bordermail.com.au/story/1633567/benalla-dams-piano-key-spillway-a-first-for-victoria/>

<sup>17</sup> <https://www.hydropower.org/blog/climate-resilience-case-study-piano-key-weirs>



Similar to the spillway gates option, adding piano keys to the primary and secondary spillway at Lake Eppalock would increase peak reservoir levels during floods. Therefore, more recreational and commercial tourism sites around Lake Eppalock would be inundated during floods if this option was implemented.

Table 11: Subjective ratings for the option to add reconfigure the primary and secondary spillway at Lake Eppalock

Element	Subjective Rating
Potential to reduce peak outflow from Eppalock	Medium – High
Reduced reliability of supply	Low
Constructability	Difficult
Capital cost of works	Very High
Operational risk	Low
Environmental impact	Low
Recreational impact	Low – Medium

## 4.7 Summary

Table 12 summarises the subjective ratings for each option. This comparison highlights some of the differences between the first three options, which would reduce the target storage or FSL at Lake Eppalock, and the next two options, which would maintain the existing FSL at Lake Eppalock but temporarily store more water behind the dam wall during floods.

Table 12: Summary of subjective ratings

Element	Subjective rating				
	Reduced target storage	Reduced target storage and increased outlet capacity	Spillway slot	Spillway gates	Piano key spillways
Potential to reduce peak outflow from Eppalock	L – H	M – H	H	M – H	M – H
Reduced reliability of supply	H	H	H	L	L
Constructability	N/A	D	D	Very D	D
Capital cost of works	N/A	H	M	Very H	Very H
Operational risk	L – M	L – M	L	H	L
Environmental impact	L – M	L	L	L	L
Recreational impact	M – H	M – H	M – H	L – M	L – M

L = low, M = medium, H = high, D = difficult



## 5. Water resource implications

### 5.1 Method

The Goulburn Simulation Model (GSM) provided by DEECA was used to assess the water resource implications of the options described in Section 4 that included a reduced target storage or reduced FSL (i.e. the first three options). The GSM is a water resource allocation model (REALM) that operates on monthly time-step, and simulates the river systems of the Goulburn, Broken, Campaspe and Loddon basins, including the volumes stored in Lake Eppalock and flows in the Campaspe River. The 'base case' version available for this study<sup>18</sup> simulates the period from July 1891 to June 2022, and represents the application of current infrastructure and system operation rules under long-term historic climate conditions, with consumptive and environmental water demands as per Victoria's water resource plans<sup>19</sup>.

Figure 15 shows how the Lake Eppalock storage trace modelled by the GSM compares with the historical record. In general, there is a reasonable match between the two time-series, though in more recent times the GSM has estimated a greater drawdown of Lake Eppalock compared with what has been observed. Comment on how this difference was accommodated when modelling flood frequencies is provided in Section 6.

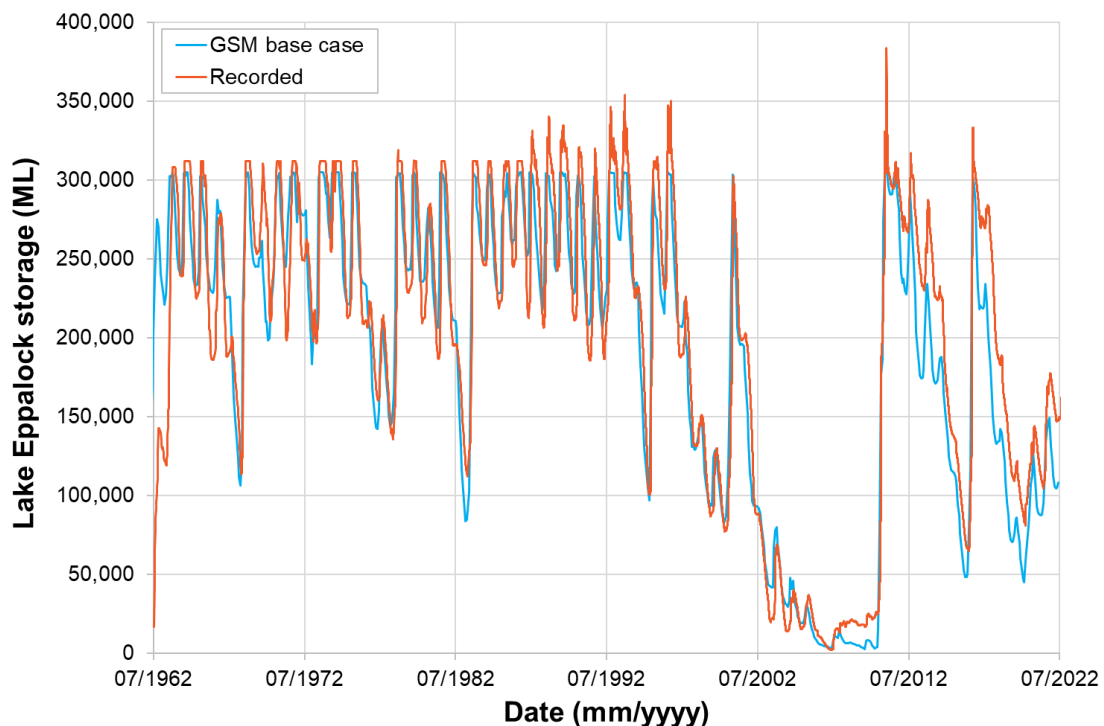

Figure 15: A comparison between the Lake Eppalock storage trace as recorded over time, and modelled in the GSM base case available for this study

<sup>18</sup> System file Gouli939.sys

<sup>19</sup> <https://www.water.vic.gov.au/our-programs/murray-darling-basin/water-resource-plans>

The base case was copied and modified to simulate the options that included a reduced target storage, in combination with the existing or increased downstream outlet capacity, by:

- Introducing new rules to the GSM that simulated the release of water from Lake Eppalock to the Campaspe River – using the available outlet capacity – if the modelled storage was greater than a set proportion of FSL. The proportions trialled were 50%, 70% and 90%<sup>20</sup> (Figure 16).
- Repeating these simulations, with the downstream outlet capacity increased to 5,000 ML/d (152,000 ML/month)<sup>21</sup>.

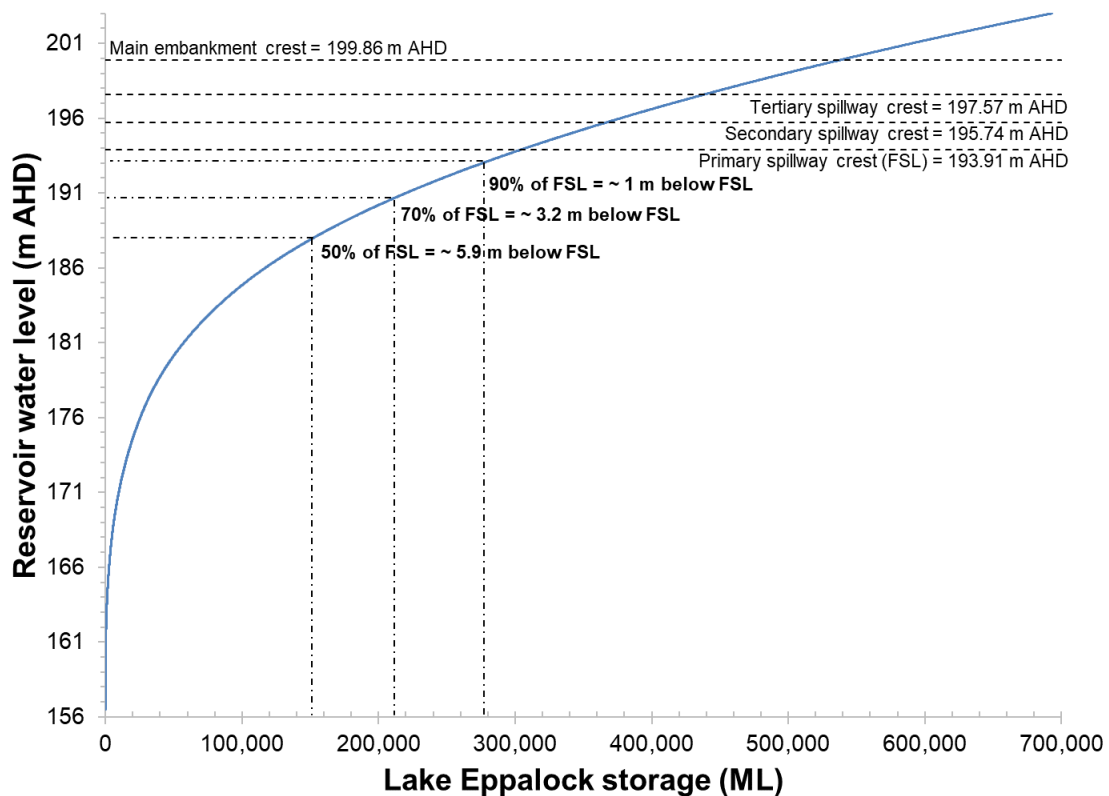

Figure 16: Lake Eppalock storage (ML) vs reservoir level (m AHD). Values are also tabled in Appendix A.

To represent the option that reduces the Lake Eppalock FSL by installing a spillway slot, the size of the storage in the GSM was reduced from 304,800 ML<sup>22</sup> to 213,360 ML.

<sup>20</sup> The initial project brief was to trial target storages of 70%, 80% and 90% of FSL, but initial estimates of the airspace required to significantly mitigate the 2011 and 2022 floods (Section 7) resulted in a change of the 80% option to 50%.

<sup>21</sup> In the base case version of the GSM, the outlet capacity is 1,850 ML/d (56,240 ML/month), which reflects the design capacity rather than recent operational capacity of the outlet. This means that the differences between the Lake Eppalock storage traces for the current outlet capacity and increased outlet capacity simulations are slightly understated.

<sup>22</sup> The difference between the Lake Eppalock storage capacity of 304,650 ML and the 304,800 ML represented in the GSM is less than 0.05%.

The GMW and Coliban Water share of Lake Eppalock capacity and inflows was maintained at 82% : 18% when simulating the options that involved a reduced target storage or FSL. The other options described in Section 4 did not need to be simulated in the GSM because they do not materially change the FSL or anticipated filling arrangements for Lake Eppalock

## 5.2 Results

Figure 17 to Figure 19 show monthly time-series of the simulated storage trace for Lake Eppalock under the options trialled. The period January 1975 to June 2022 is shown – rather than the whole period modelled – so that the plots are easier to interpret. The period post-1975 is also more representative of recent climate conditions in Victoria compared with pre-1975 (DELWP, 2020).

Specifically:

- Figure 17 contains the storage traces for the options to reduce target storage to 50%, 70% or 90% of FSL using existing infrastructure
- Figure 18 contains the storage traces for the options to reduce target storage to 50%, 70% or 90% of FSL, using an increased outlet capacity of 5,000 ML/d
- Figure 19 compares the storage traces for the options to reduce target storage to 70% of FSL using either the existing infrastructure or increased outlet capacity, or to reduce FSL to 70% of the current FSL.

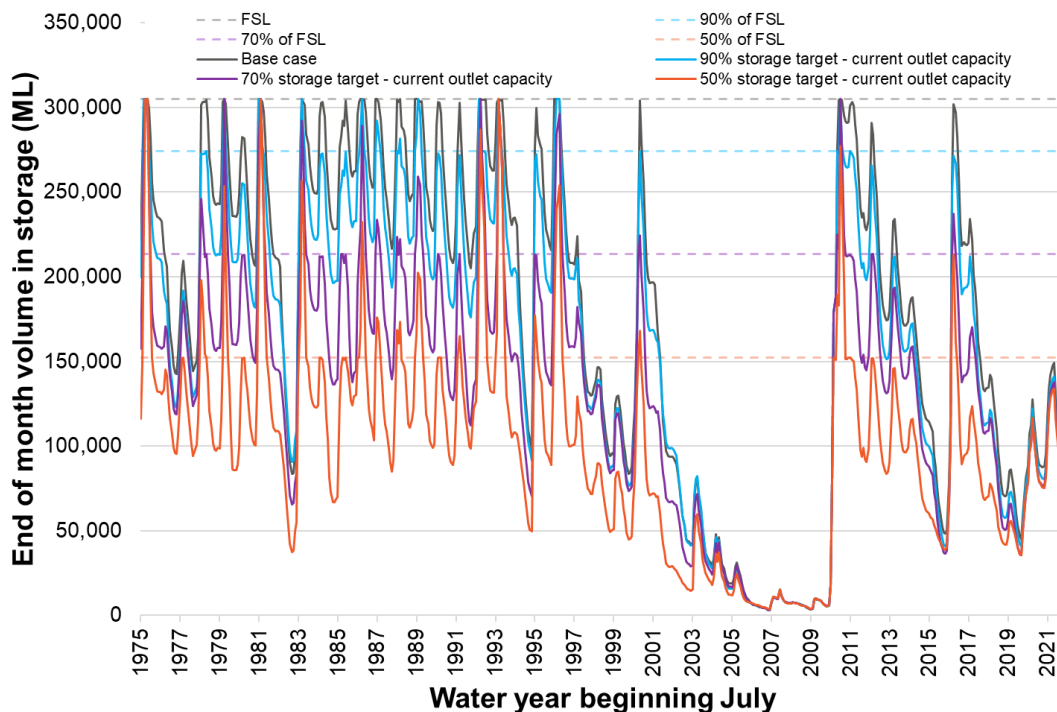

Figure 17: Monthly time-series of the modelled storage trace for Lake Eppalock, from January 1975 to June 2022, for the options to reduce target storage to 50%, 70% or 90% of FSL using existing infrastructure.

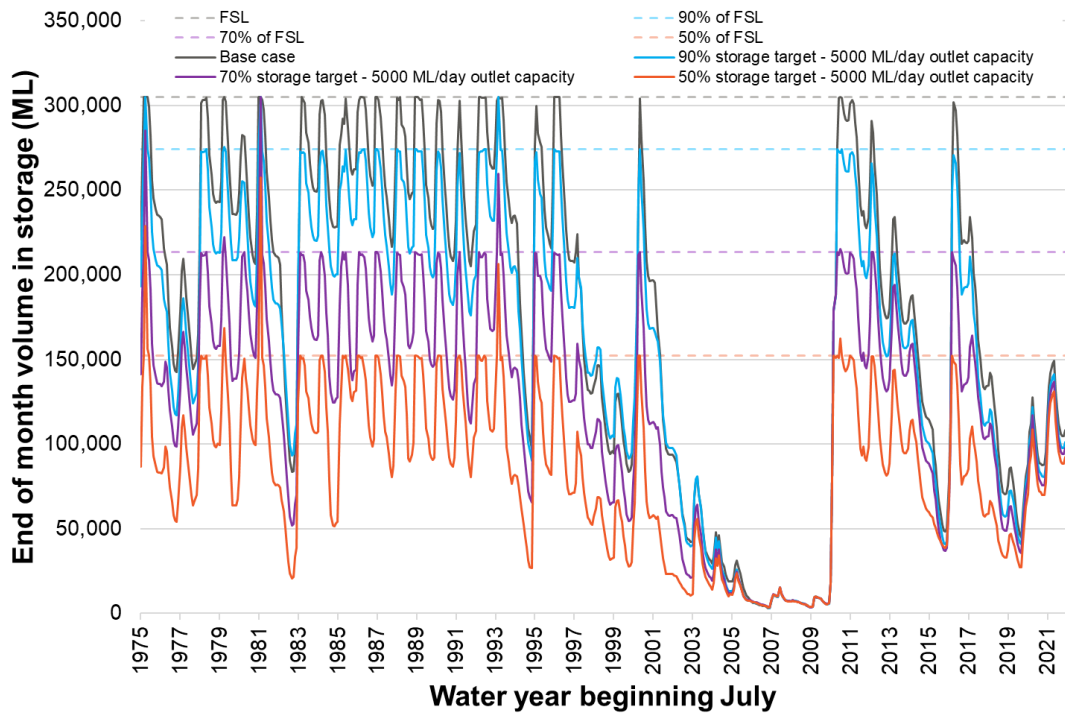

Figure 18: Monthly time-series of the modelled storage trace for Lake Eppalock, from January 1975 to June 2022, for the option to reduce target storage to 50%, 70% or 90% of FSL using a 5,000 ML/d outlet capacity

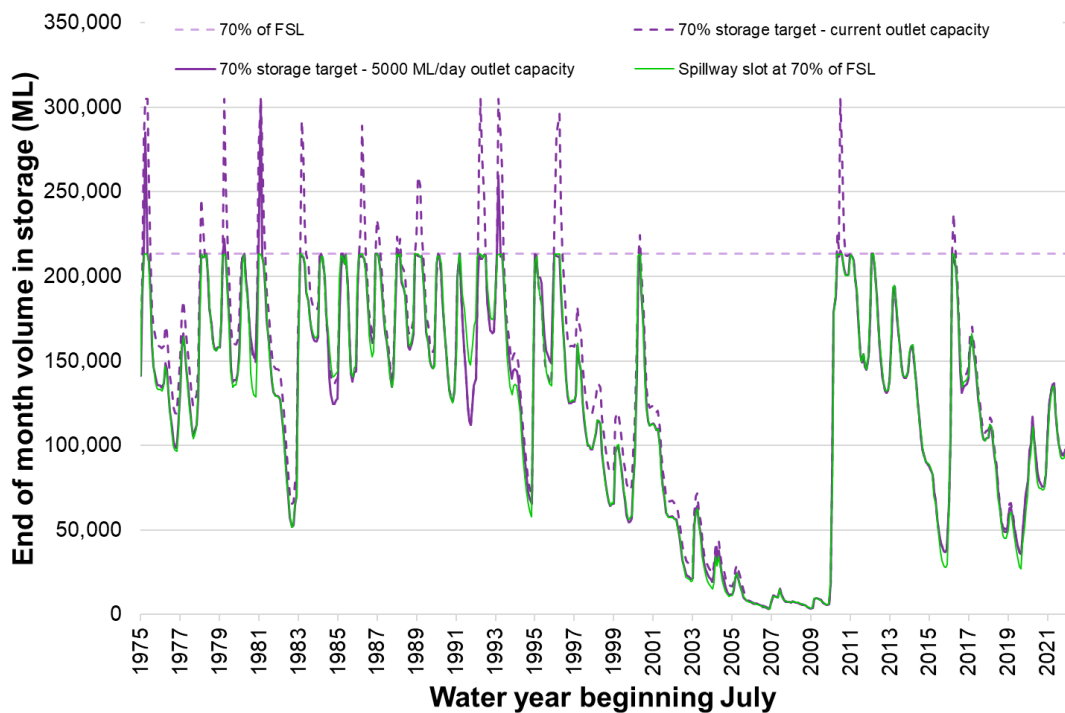

Figure 19: Monthly time-series of the modelled storage trace for Lake Eppalock, from January 1975 to June 2022, for the option to reduce target storage to 70% of FSL using existing infrastructure or a 5,000 ML/d outlet capacity, or reduce FSL to 70% of current FSL



These time-series – for the whole modelled period – are converted into time of exceedance curves in Figure 20 and Figure 21. These curves are the key outputs from the water resource modelling used to simulate the expected flood frequency changes immediately downstream of Lake Eppalock (Section 6).

The time-series and time of exceedance curves demonstrate that:

- The largest differences between the modelled storage traces are attributable to the proportion of FSL used to set the target storage – i.e. 50%, 70% or 90% of FSL. As the target storage is reduced, the amount of airspace in Lake Eppalock increases for most of the modelled period of record.
- Increasing the outlet capacity to 5,000 ML/d reduces the proportion of time that the modelled storage trace is above the target storage.
- Reducing the FSL rather than the target storage results in a more permanent shift of the Lake Eppalock storage trace, particularly when compared with the option where there is no increase in outlet capacity.

Some of the water resource implications of reducing the target storage or FSL at Lake Eppalock are also apparent in these plots. For example:

- The water available in Lake Eppalock during the first 10 years of the Millennium Drought (1997 – 2007) progressively declines as the target storage or FSL is reduced from 90% to 70% to 50% of the current FSL.
- The period during the 2000s when Lake Eppalock is essentially empty (2007 – 2010 in the base case) starts much earlier (circa 2002) in the option where the target storage is reduced to 50% of FSL.

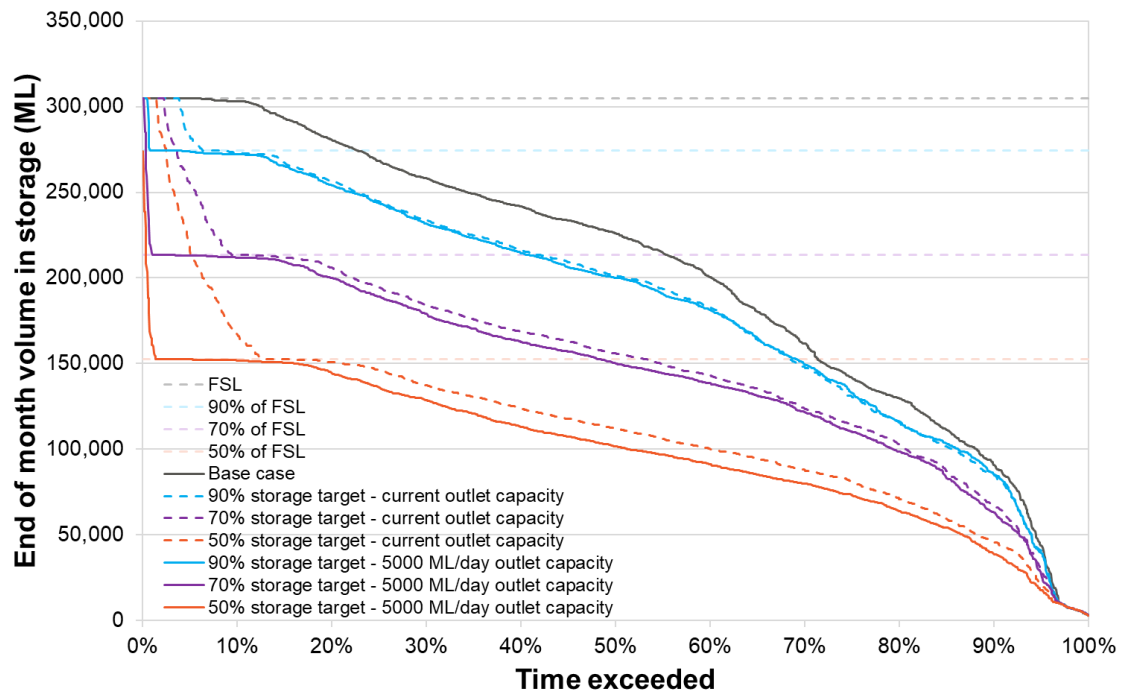

Figure 20: Modelled time of exceedance curves for the options to reduce the target storage at Lake Eppalock to 50%, 70% or 90% of FSL using existing infrastructure, or with outlet capacity increased to 5,000 ML/d

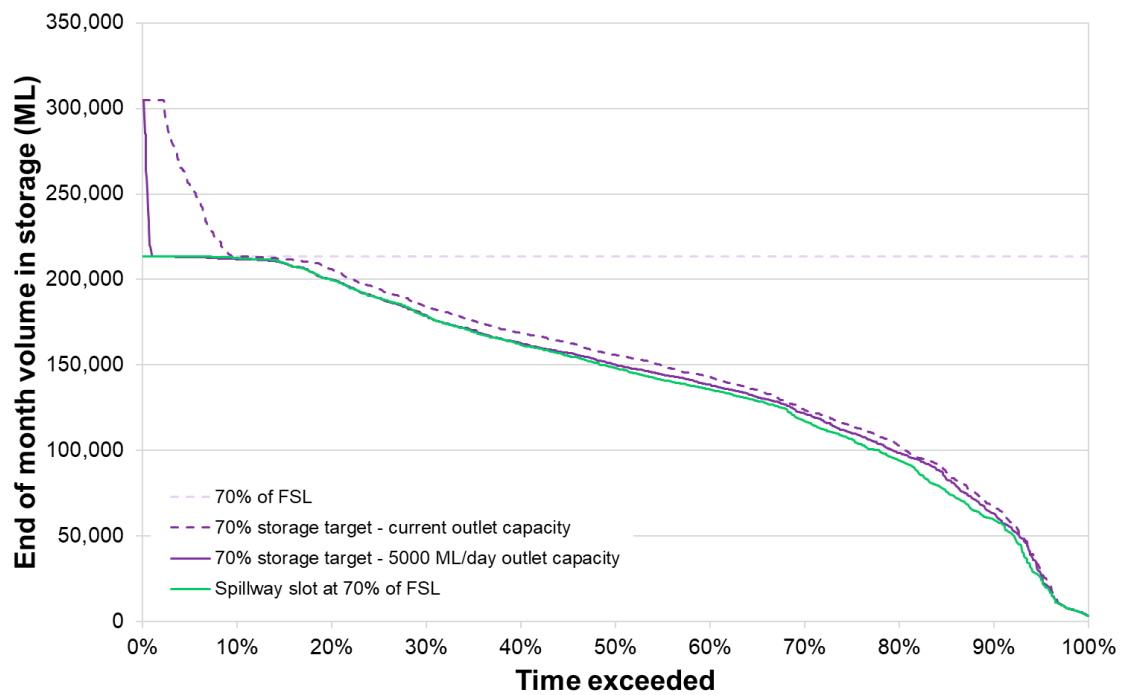

Figure 21: Modelled time of exceedance curves for the options to reduce the target storage at Lake Eppalock to 70% of FSL using existing infrastructure, or with outlet capacity increased to 5,000 ML/d, or reduce FSL to 70% of current FSL



Providing more airspace by drawing down Lake Eppalock to target storages less than FSL or by reducing FSL decreases the modelled reliability of supply to entitlement holders in the Campaspe River system. For example, compared with the base case, average February allocations to high-reliability water shares (HRWS) decline by approximately 0.5%, 1.5% and 6% if the target storage or FSL is reduced to 90%, 70% and 50% of the current FSL respectively, and average February low-reliability water share (LRWS) allocations decrease by approximately 5%, 15% and 30% (Table 13). Modelled allocations at the beginning of severely dry periods are also noticeably reduced. For example, Figure 22 shows that during 2002/03 allocations are ~0% to HRWS under the 50% and 70% storage target or FSL options, compared with allocations of ~40% to HRWS in the base case.

Figure 23 provides more detail on how February allocations to HRWS and LRWS in the Campaspe system would be anticipated to change under the options considered. For example, the proportion of years with no LRWS allocation is simulated to increase from ~20% under the base case to ~50% for the 50% of FSL storage target option, and the proportion of years with 100% allocation to HRWS is modelled to reduce from ~90% to ~70%.

Figure 23 also includes information on how modelled October allocations to HRWS and LRWS change. This shows that the differences between the base case and various options is generally larger – particularly for the 50% and 70% of FSL options – in October compared with February. That is, early season allocations will be more sensitive to changes to target storage or FSL versus later season allocations.

Changing the target storage or FSL at Lake Eppalock also affects the Goulburn and Coliban systems, given the inter-connectedness of the water supply systems in northern Victoria. For the options considered in this assessment, February allocations for the Goulburn system are generally unchanged. For the Coliban system however, the modelled average annual volume supplied from Lake Eppalock reduces by 300 ML (3%), 600 ML (7%) and 1,500 ML (16%) compared with the base case if the target storage or FSL is reduced to 90%, 70% and 50% of the current FSL respectively (Table 14). Reducing supply from Lake Eppalock to the Coliban system would potentially increase the frequency of restrictions for Coliban Water's urban customers, and/or volumes supplied to their rural customers.

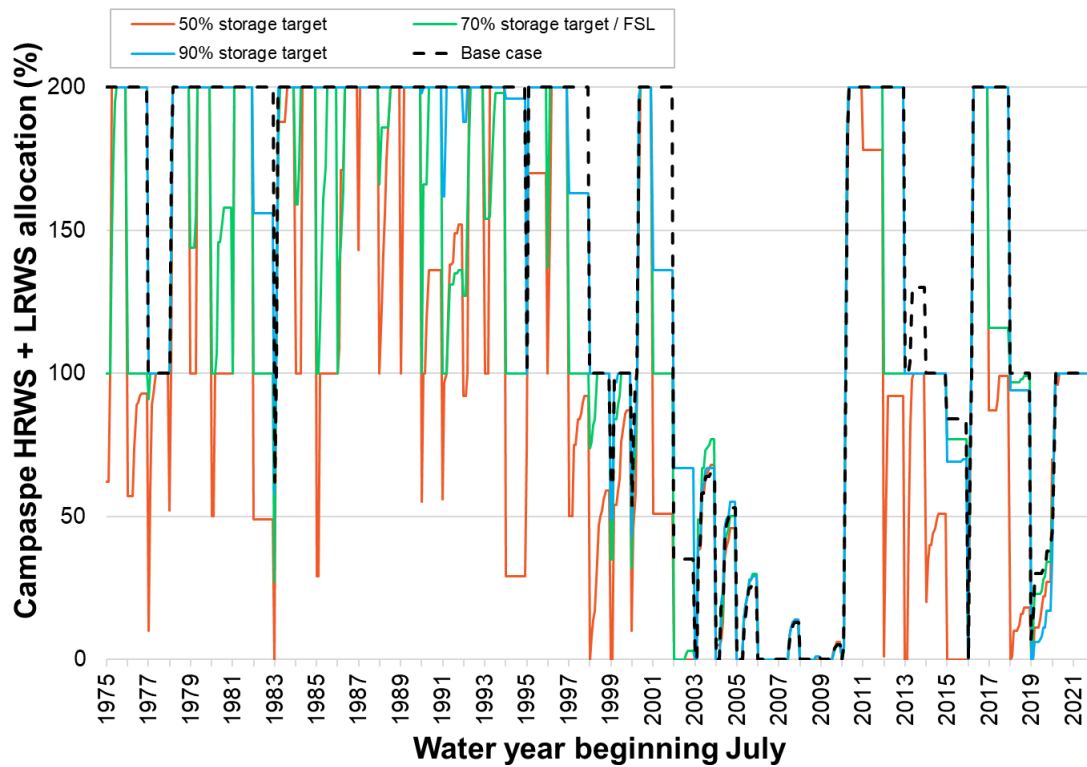

Figure 22: A time-series of modelled seasonal determinations (allocations) to HRWS and LRWS in the Campaspe system – assuming long-term historic climate conditions – for the base case and the options to reduce the Lake Eppalock storage target or FSL

Table 13: Modelled average February allocations to HRWS and LRWS in the Campaspe and Goulburn systems

Option	Average modelled February allocations (July 1891 – June 2022)			
	Campaspe system		Goulburn system	
	HRWS	LRWS	HRWS	LRWS
Base case	<b>94%</b>	<b>76%</b>	<b>97%</b>	<b>50%</b>
90% target storage	94%	71%	97%	50%
70% target storage / FSL	93%	60%	97%	50%
50% target storage	87%	45%	97%	50%

Table 14: Modelled change in average annual volume supplied to the Coliban system from Lake Eppalock

Option	Modelled supply from Lake Eppalock to Coliban system (July 1891 – June 2022)	
	Average annual volume (ML)	Difference to base case (ML)
Base case	9,200	-
90% target storage	8,900	300
70% target storage / FSL	8,600	600
50% target storage	7,700	1,500

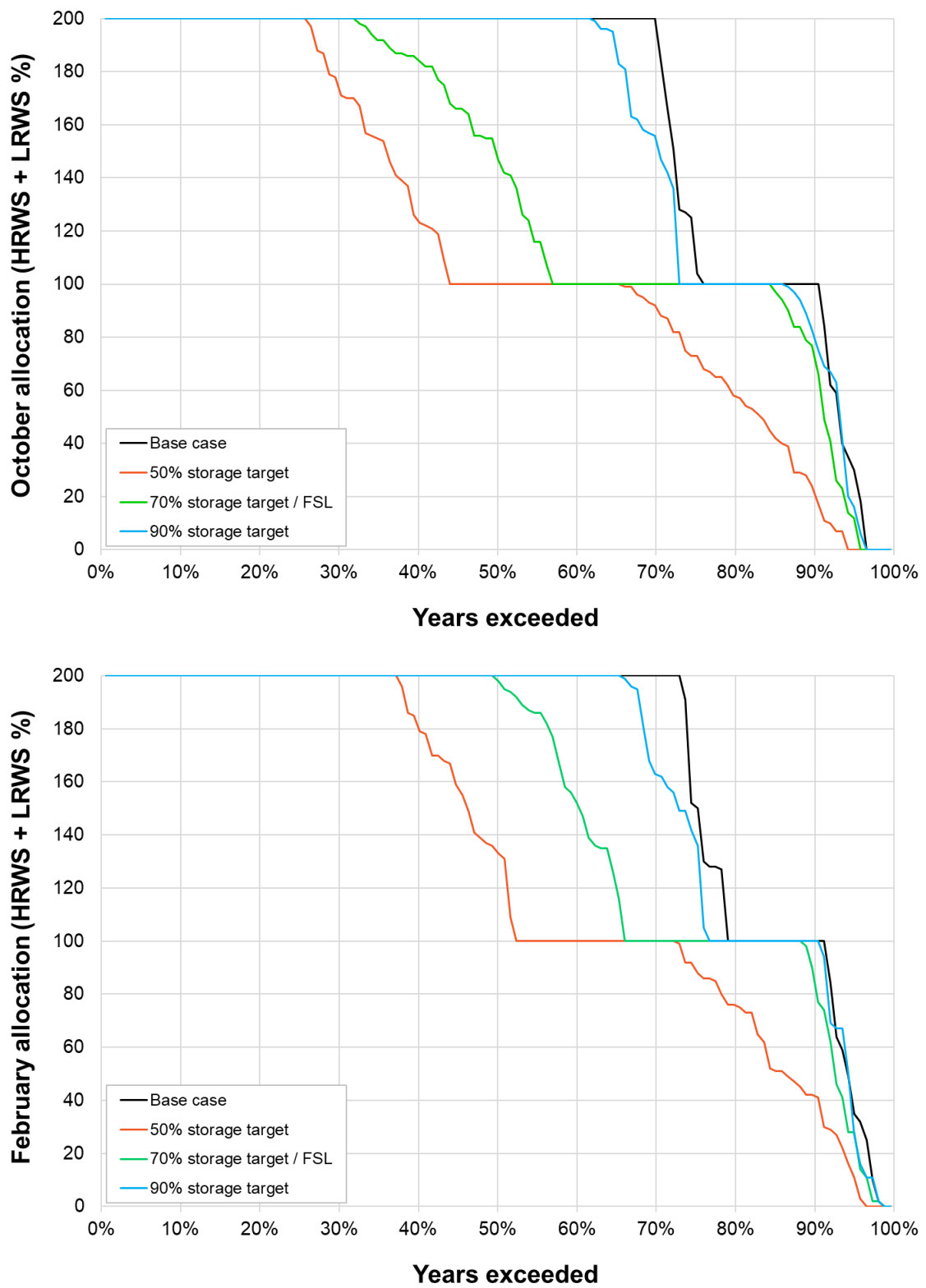

Figure 23: The proportion of years when seasonal determinations (allocations) of varying percentages to HRWS and LRWS in the Campaspe system are exceeded – assuming long-term historic climate conditions – when considering either October (top) or February (bottom)



## 6. Flood frequency changes – Lake Eppalock

### 6.1 Method

An existing flood hydrology (RORB) model of the Lake Eppalock catchment was applied to simulate how the options described in Section 4 would change flood frequencies immediately downstream of the storage. The RORB model was first developed by SKM (1998) and was last updated by HARC (2017). It simulates rainfall events ranging in burst durations from 12 hours to 168 hours.

RORB (Laurenson and Mein, 1995) is a runoff and streamflow routing program that calculates flood hydrographs from spatially-distributed rainfall and stream network inputs. RORB subtracts losses from sub-daily rainfall time-series of a given annual exceedance probability (AEP) to determine rainfall excess, and then routes the rainfall excess through the catchment to produce streamflow hydrographs at points of interest.

RORB also has the capacity to use a Monte-Carlo approach to produce flood frequency estimates that incorporate the joint probability of flood-causing factors (e.g. rainfall depth, rainfall temporal pattern, losses and reservoir airspace). For the assessment of potential operating and infrastructure options for increasing the flood mitigation provided by Lake Eppalock, the Monte-Carlo framework refined by HARC (2017) was used (Figure 24), but with the reservoir drawdown distributions taken from Figure 20 and Figure 21 in Section 5.

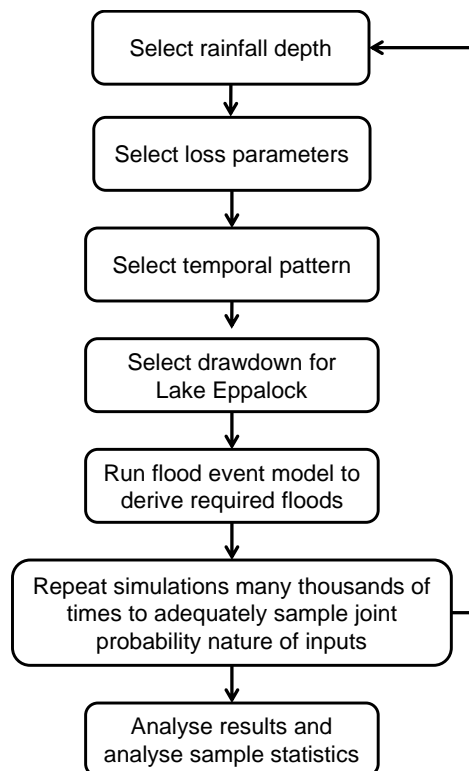

Figure 24: Joint probability framework used to simulate how the options in Section 4 would change flood frequencies immediately downstream of Lake Eppalock, based on the drawdown distributions modelled in Section 5

Figure 25 shows how results from the Lake Eppalock RORB model, when run using the base case drawdown distribution from Section 5, compared with results from the HARC (2017) study (using either the modelled drawdown distribution available at that time, or assuming Lake Eppalock is at FSL). The 'base case' flood frequency curve sits below the HARC (2017) results, which means that the modelled base case drawdown available for this assessment of operating and infrastructure options for increasing the flood mitigation provided by Lake Eppalock, is greater than the modelled drawdown used in the HARC (2017) study.

Also shown for context on Figure 25 is a curve fitted to the annual maxima of historic spills from Lake Eppalock (curve fitted as a GEV distribution with LH2 shift). This historic flood frequency curve sits above the RORB model results, but the confidence limits around the fitted distribution demonstrate the degree of uncertainty. The base case RORB model results are within the confidence limits of the historic flood frequency distribution, which indicates that the model is fit-for-purpose for comparing simulated flood frequencies between the base case and the options described in Section 4. However, if the RORB model is to be used for more detailed investigation of flood mitigation options or future dam safety investigations, it will need to be re-calibrated and verified using rainfall and streamflow observations available for the 2022 flood.

In this report section, outflows from Lake Eppalock as modelled using RORB are reported in m<sup>3</sup>/s rather than ML/d to indicate they represent the peaks of events, rather than the volume. Values in m<sup>3</sup>/s can be converted to ML/d by multiplying them by 86.4. For example, the peak outflow from Lake Eppalock in 2022 was approximately 1,190 m<sup>3</sup>/s or 103,000 ML/d.

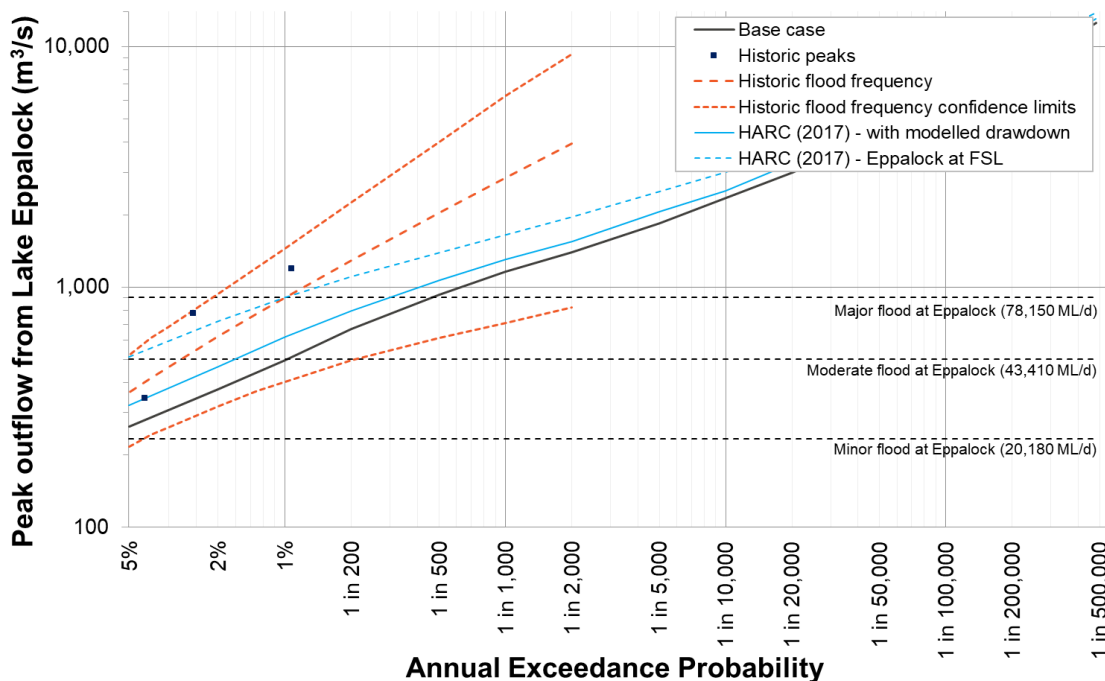

Figure 25: RORB model estimates of peak outflow frequencies for Lake Eppalock, comparing results from the HARC (2017) study [blue lines] with those obtained when the RORB model is re-run using the base case drawdown distribution from Section 5 [black line]. Also shown for context is a curve fitted to the annual maxima of historic spills from Eppalock [orange lines].



## 6.2 Revised spillway ratings

For the options that involved adding a passive slot to the spillway (Section 4.4), adding spillway gates to the primary spillway (Section 4.5) or adding piano keys to the primary and secondary spillways (Section 4.6), the rating curve for Lake Eppalock in the RORB model was revised to reflect the expected change in discharge vs reservoir level.

For the passive spillway slot option, it was assumed that the slot width would be 13.5 m (i.e. the width of two concrete monoliths in the primary spillway), with a crest level at 70% of FSL (i.e. 190.74 m AHD or approximately 3.2 m deep). The corresponding rating for the primary spillway with this passive slot included is shown in Figure 26, as compared with the current rating. This shows that the slot could pass approximately 11,800 ML/d downstream of Lake Eppalock before the full width of the primary spillway is engaged (i.e. when the reservoir level rises above 193.91 m AHD).

For the piano key spillways option, the following configuration was adopted:

- Primary spillway: retain a 34 m long central portion of the existing primary spillway with crest level at 193.91 m AHD, and add two piano key spillways 21 m long either side of this with a crest elevation of 196.91 m AHD (i.e. 3 m above FSL)
- Secondary spillway: add piano keys across the full width of the secondary spillway, with a crest elevation of 198.74 m AHD (i.e. 3 m above current secondary spillway crest)
- Tertiary spillway: add an erodible crest with an elevation of 199.5 m AHD, so that the tertiary spillway is not engaged more frequently given the throttling of flows through the primary spillway and raising of the secondary spillway. If overtopped, the crest would erode to the current tertiary spillway elevation of 197.57 m AHD.

The purpose of this configuration was to increase the flood mitigation provided by Lake Eppalock by reducing the peak outflow at a given reservoir level, until the reservoir level nears the dam crest. The revised spillway ratings were estimated using an empirical equation derived by Machiels (2012), which is appropriate for this investigation, but not sufficiently accurate for more detailed spillway design. Therefore, the potential change in spillway ratings would need to be confirmed using a computational fluid dynamics (CFD) model if the option to add piano keys to the Lake Eppalock spillways is demonstrated to be worth further consideration.

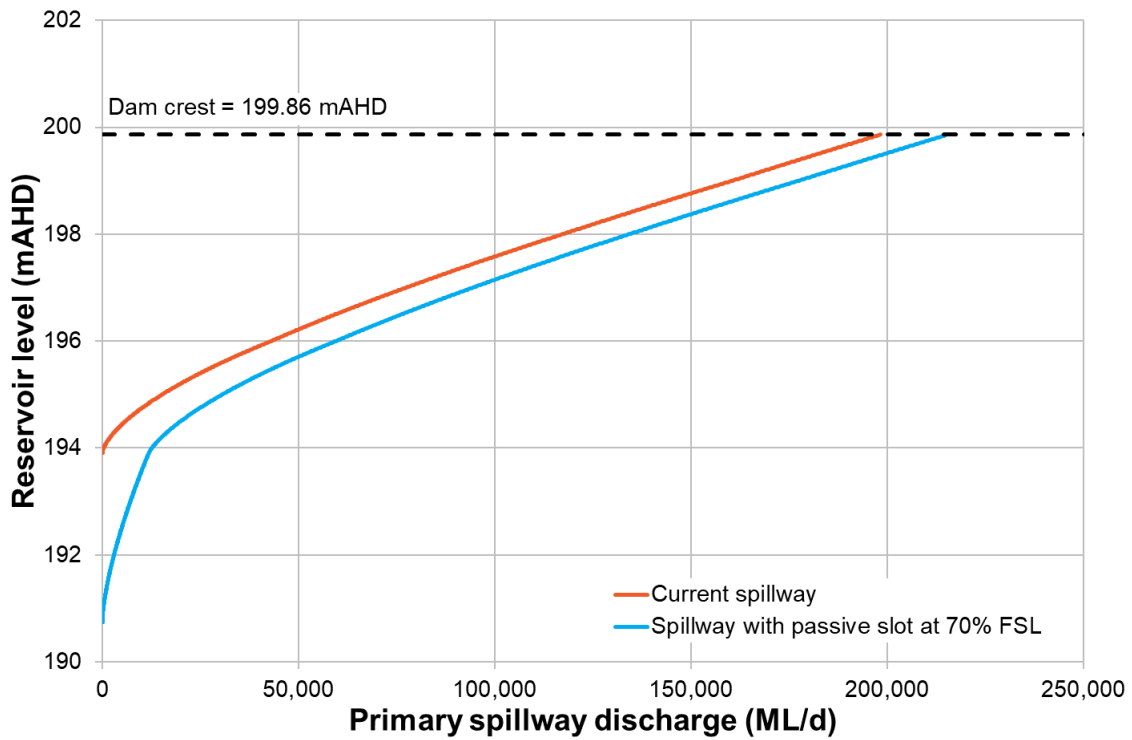

Figure 26: Modelled change in primary spillway rating at Lake Eppalock if a passive slot is added with a crest level at 70% of current FSL

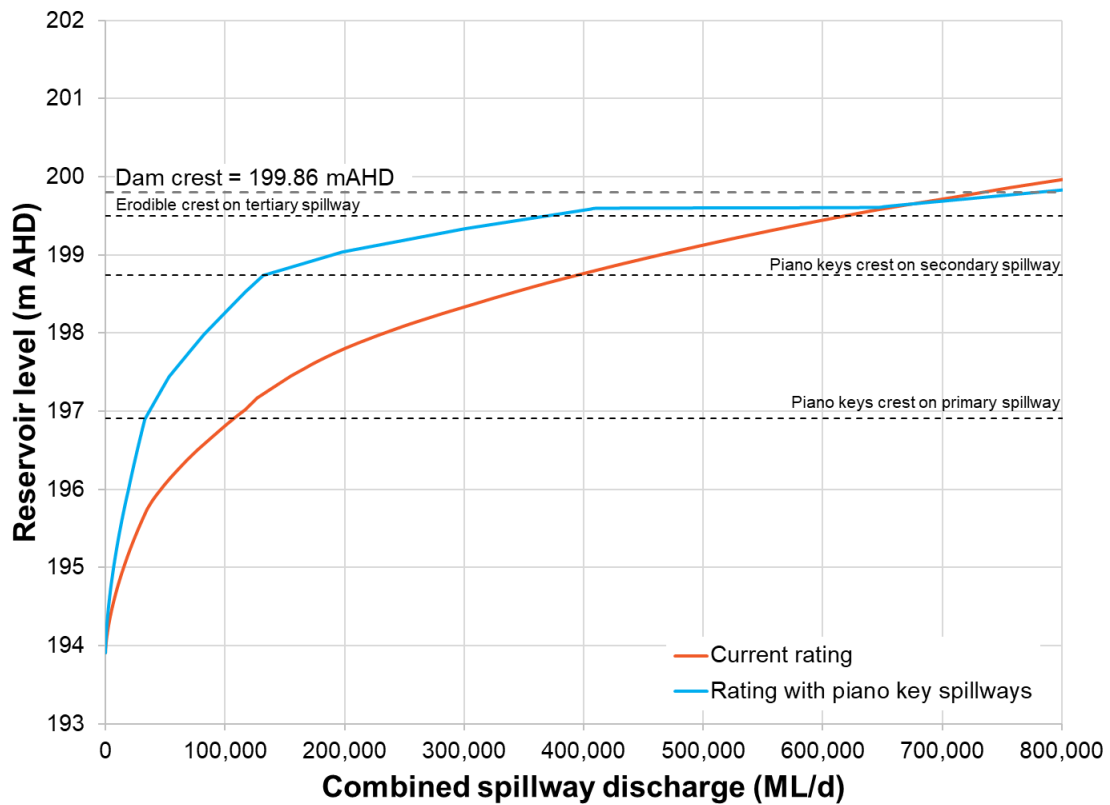

Figure 27: Modelled change in spillway rating at Lake Eppalock if piano keys are added to the primary and secondary spillway, and an erodible crest to the tertiary spillway

To simulate the spillway gates option, a generic gate operations module was ported into the Lake Eppalock RORB model and used to represent the potential surcharging of the reservoir during floods. Empirical equations available in Section 5 of the Queensland Urban Drainage Manual (2007) were used to estimate the volume of additional flood storage that would have been needed at Lake Eppalock during the January 2011 and October 2022 events to reduce the peak outflows to 40,000 ML/d. 40,000 ML/d is below the moderate flood threshold at Eppalock, and based on Figure 10, spills greater than this are likely to result in major flooding at Rochester.

Figure 28 shows the results of this assessment for the October 2022 flood, and demonstrates that:

- Approximately 130,000 ML of the 2022 inflows would have needed to be stored at Lake Eppalock to reduce the peak outflow from approximately 100,000 ML/d to 40,000 ML/d. This is almost double the volume that Lake Eppalock stores (approximately 70,000 ML) above FSL when outflows are 40,000 ML/d through the current spillway arrangements.
- If spillway gates were used to reduce peak outflows from Lake Eppalock during the 2022 flood from approximately 100,000 ML/d to 40,000 ML/d, they would need to be capable of safely surcharging the reservoir by ~3.6 m above FSL.

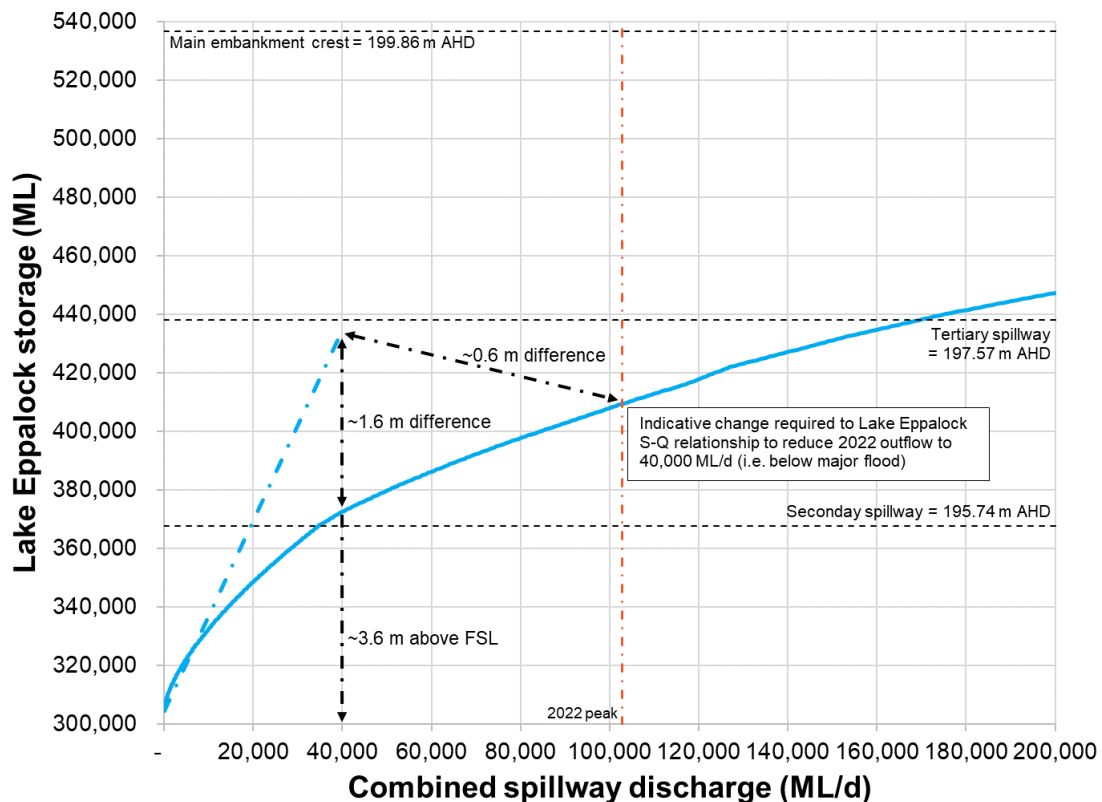

Figure 28: A representation of the indicative difference that would need to be made to the Lake Eppalock storage (S) vs discharge (Q) relationship if outflows during a repeat of the 2022 flood were to be reduced from approximately 100,000 ML/d to 40,000 ML/d





Based on this analysis, the following operation rules were adopted to simulate the spillway gate option in RORB:

- Outflow of  $\leq 10,000$  ML/d: no surcharge required, outflow is less than bankfull
- Outflow of 10,000 ML/d – 20,000 ML/d: surcharge up to  $\sim 1.8$  m above FSL
- Outflow of 20,000 ML/d – 30,000 ML/d: surcharge up to  $\sim 2.7$  m above FSL
- Outflow of 30,000 ML/d – 40,000 ML/d: surcharge up to  $\sim 3.6$  m above FSL
- Outflow of  $\geq 40,000$  ML/d: spillway gates fully open

To mitigate the dam safety implications of surcharging the reservoir by more than would occur with the existing spillway arrangements, and to prevent the secondary spillway operating more often than is currently the case, this option would also involve:

- Raising the secondary spillway crest by 3 m
- Raising the embankments at Lake Eppalock to 202.1 m AHD, and in doing so removing the tertiary spillway (see Section 8.1.3 for more detail). This elevation was estimated by converting the RORB model results in Figure 34 to reservoir levels using the rating curves in Figure 29, and calculating the embankment raise required to maintain the AEP of overtopping at the existing  $\sim 1$  in 200,000 (HARC, 2017).

Figure 29 shows the total spillway flow vs reservoir level at Lake Eppalock for the gated spillway option, and how this compares with the existing spillway rating. However, further optimisation of the spillway gate configuration and the associated cost, flood mitigation potential, dam safety risks and operational risks would be required before this option was implemented.

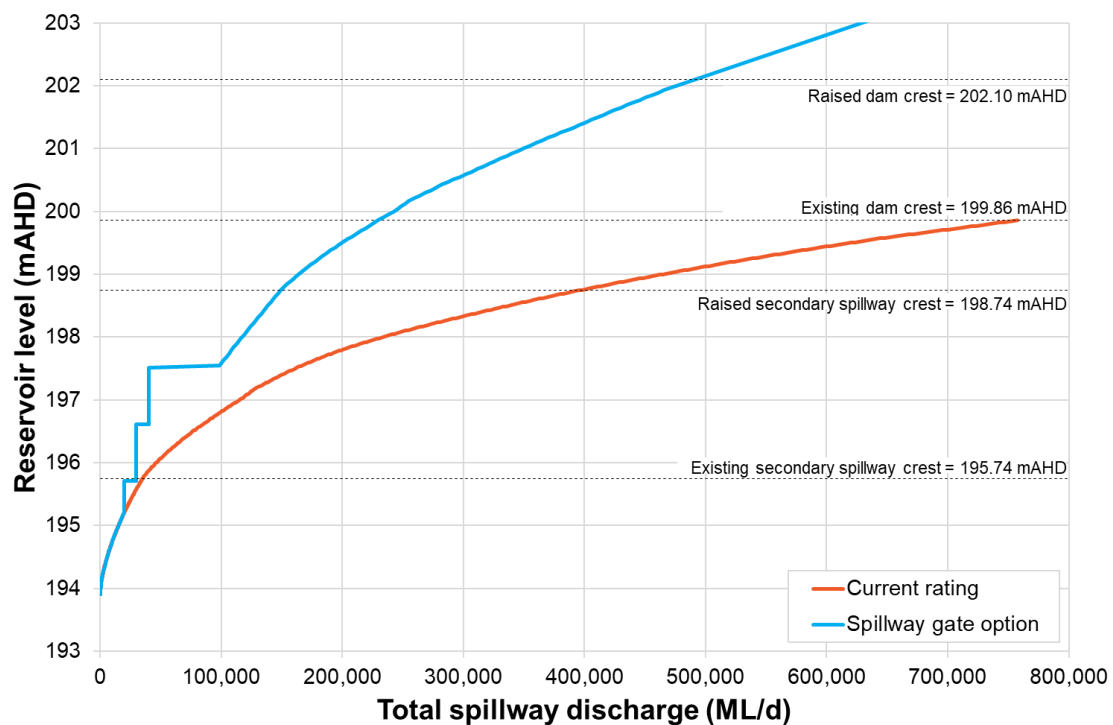

Figure 29: Modelled change in spillway rating at Lake Eppalock if gates are added to the primary spillway, the secondary spillway is raised 3 m, and the tertiary spillway is removed



### 6.3 Pre-releases in response to forecasts

If water was discharged from Lake Eppalock in response to forecasts of wet conditions, the maximum daily volume that could be released without exceeding bankfull conditions in the Campaspe River is approximately 10,000 ML/d<sup>23</sup>. Historically, spills up to 10,000 ML/d from Lake Eppalock have also generally avoided minor flooding at Rochester (Figure 10).

The question then becomes over what duration pre-releases could be feasibly made prior to floods at Lake Eppalock. As storage operator, GMW can only make pre-releases if a) water released from storage will be replenished by inflows resulting from the forecast rainfall and b) releases will not exacerbate downstream flooding. Pre-release decisions at Lake Eppalock therefore need to consider both rainfall and streamflow forecasts at locations upstream and downstream of the storage.

Figure 30 shows the skill of the existing 7-day streamflow forecasts for the Campaspe River at Redesdale (i.e. upstream of Lake Eppalock). The catchment to Redesdale is approximately 30% of the total area upstream of Lake Eppalock, but is a good indicator of total inflows to Lake Eppalock (Figure 31). A forecast skill of 100% represents a perfect prediction, whereas 0% is for forecasts no better than predictions based on the historical record. Figure 30 demonstrates that for the Campaspe River, streamflow forecast performance at Redesdale is good for 1-day ahead, but the forecast skill diminishes at longer lead times.

The 7-day streamflow forecast skill for the Campaspe River catchment suggests that the Lake Eppalock storage operator would be unable to confidently make pre-releases well in advance of floods, given the uncertainty associated with streamflow predictions beyond 1-day ahead. A pre-release of 10,000 ML/d for 1-day would create 10,000 ML of airspace in Lake Eppalock if there are no inflows to storage already occurring. This volume is equivalent to 3% of the 304,650 ML stored at FSL.

The potential airspace that may be achievable by pre-releasing below FSL is small compared with the additional flood storage above FSL that may be achievable at Lake Eppalock if spillway gates were used to surcharge the reservoir by up to 3.6 m (Figure 27). Therefore, for this assessment the RORB modelling of the spillway gate option has not included any pre-releases, and the engineering concept design (Section 8) is based on gates being added to the existing spillway (rather than the spillway crest being lowered, and the gates used to maintain existing FSL).

---

<sup>23</sup> [https://vewh.vic.gov.au/data/assets/pdf\\_file/0006/357540/Campaspe-Flow-Objectives-and-revised-flow-recs-report-final.pdf](https://vewh.vic.gov.au/data/assets/pdf_file/0006/357540/Campaspe-Flow-Objectives-and-revised-flow-recs-report-final.pdf)

## 7-day Ensemble Streamflow Forecasts

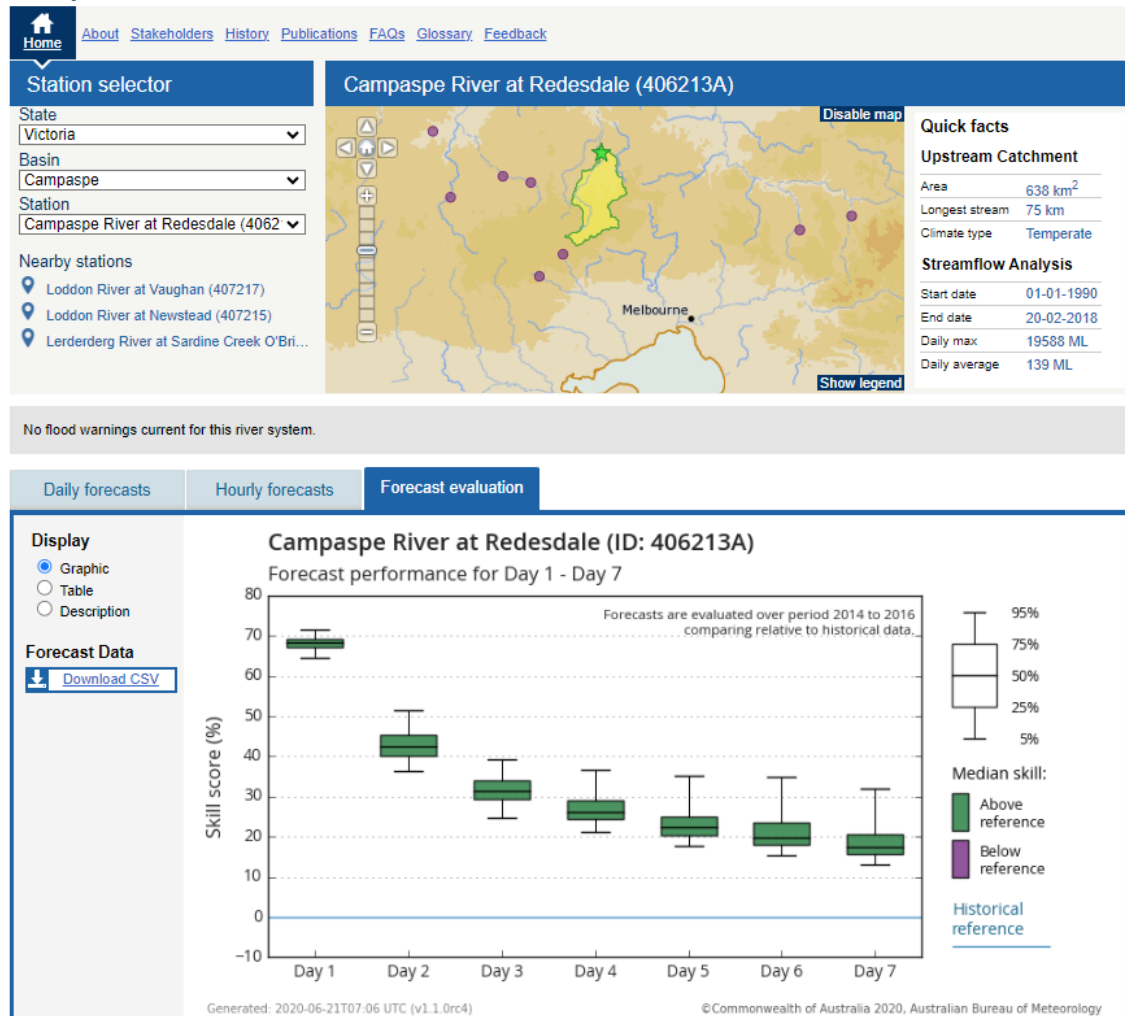

Figure 30: Skill scores for 7-day streamflow forecasts for the Campaspe River at Redesdale (i.e. upstream of Lake Eppalock); [www.bom.gov.au/water/7daystreamflow/index.shtml#panel=model\\_evaluation&id=406213A](http://www.bom.gov.au/water/7daystreamflow/index.shtml#panel=model_evaluation&id=406213A)

The challenges associated with making pre-release decisions at Lake Eppalock are also demonstrated by comparing daily time-series of flow recorded for the Campaspe River at Redesdale with flow recorded for the River Murray at Biggara, which is upstream of Hume Dam (Figure 31). Both the Redesdale and Biggara gauges are part of the Bureau's hydrologic reference stations network<sup>24</sup>. This comparison shows that the Campaspe River streamflow – whether gauged at Redesdale or estimated by GMW as total inflow to Lake Eppalock – is much flashier compared with the River Murray upstream of Hume Dam. That is, the baseflow component of the Campaspe River streamflow is relatively small, and flows quickly oscillate between 'low' and 'high' depending on rainfall. This means that Lake Eppalock inflow volumes are relatively more difficult to predict over weeks and months, compared with locations where baseflow – which varies more gradually with time – is a larger component of total streamflow.

<sup>24</sup> <http://www.bom.gov.au/water/hrs/>

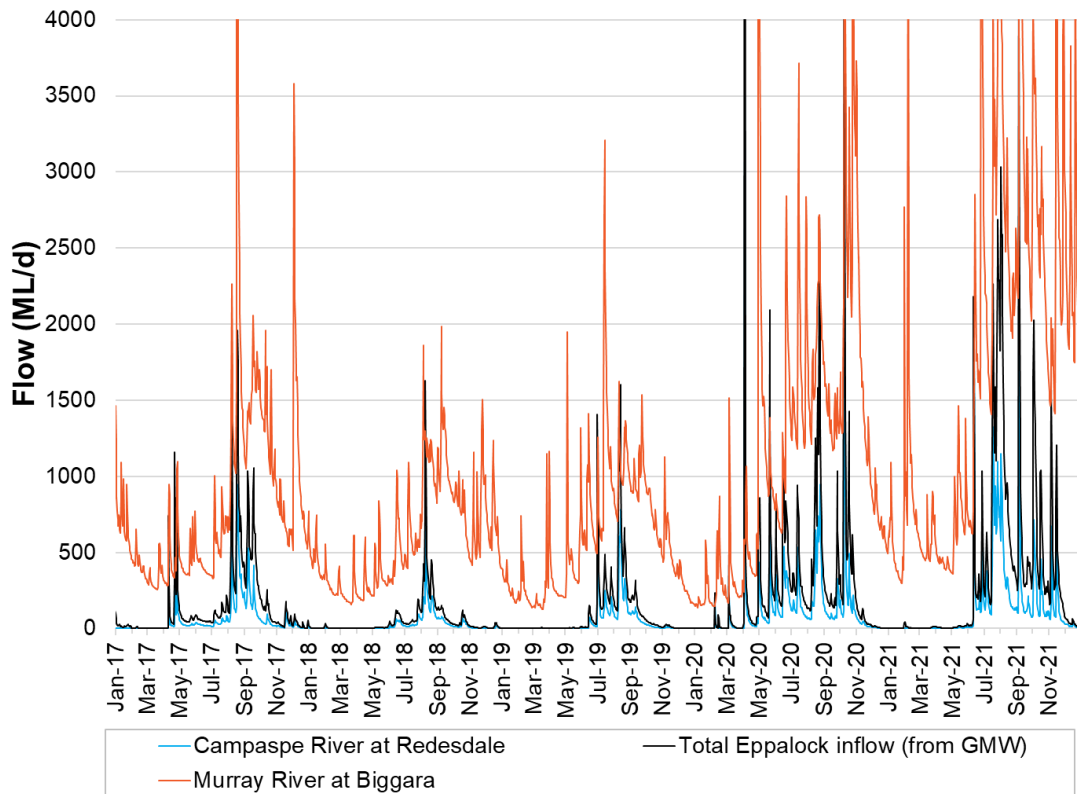

Figure 31: Example time-series of daily flow recorded for the Campaspe River at Redesdale and the River Murray at Biggara. The Campaspe River flow is ‘flashier’ compared with the River Murray flow. Also shown are total inflows to Lake Eppalock, as estimated by GMW.

Streamflow forecast skill for the week or months ahead is however only one element of the uncertainty associated with using forecasts when considering pre-releases from storage below FSL. Preceding and during flood events, other rainfall and shorter-term flood forecasts are available from the Bureau of Meteorology. These products can provide qualitative guidance (‘situational awareness’) that assists storage operators to make release decisions in accordance with their flood management policies, plans and manuals<sup>25</sup>. The DELWP (2022) *Guideline for the use of rainfall forecasts to make releases from dams in Victoria* describes the available rainfall forecast products and flood forecasting systems, and recommends that forecast uncertainties be considered in dam owner decisions during events. Importantly, the DELWP (2022) guideline notes that *significant further development [is required] before rainfall forecasts could be quantitatively applied to release planning for dams*. An example of the uncertainties associated with rainfall forecasts is provided in Section 7.2.2.

The DELWP (2022) guideline also notes that several new forecast products, such as NextGen rainfall products, Seamless Rainfall ensemble forecasts, rainfall post-processing technologies, and 7-day ensemble streamflow forecasts are being developed by the Bureau and various agencies. However, these products are not expected to be available in the short to mid-term future in the form of forecasts for specific catchments that represent the full range of potential rainfall and streamflow quantities and locations for both short-term and longer-term durations.

<sup>25</sup> For example see the [GMW flood operations policy](#)

Furthermore, before these new products are useful for managing dam operations, it will be necessary to develop catchment-specific ways of using them to make trade-off decisions about the risks associated with pre-releases (such as a quantitative risk assessment frameworks), given the uncertainties in rainfall and streamflow forecasts that will remain regardless of future improvements in forecast skill.

## 6.4 Results

Three figures are included below comparing RORB model estimates of Lake Eppalock peak outflow AEPs between the base case and the options:

- That involve a target storage of 50%, 70% or 90% of FSL, with either the existing outlet capacity or outlet capacity increased to 5,000 ML/d (Figure 32).
- To reduce the target storage at Lake Eppalock to 70% of FSL using existing infrastructure, or with outlet capacity increased to 5,000 ML/d, or to add a spillway slot at 70% of current FSL (Figure 33).
- To add a spillway slot at 70% of current FSL, add spillway gates to the primary spillway, or install piano key spillways on the primary and secondary spillways, and an erodible crest on the tertiary spillway (Figure 34).

On these figures, horizontal lines are also included showing thresholds equivalent to a minor, moderate and major flood at Eppalock (20,180 ML/d, 43,410 ML/d and 78,150 ML/d respectively).

Based on these plots, Table 15 and Table 16 respectively summarise:

- The estimated reduction in the peak 1% (1 in 100) AEP outflow from Lake Eppalock under each option compared with the base case.
- The estimated AEP of the Lake Eppalock peak outflow exceeding the minor, moderate and major flood thresholds for the Campaspe River at Eppalock.

Given the differences between the observed flood frequencies and RORB model predictions in Figure 25, the results reported here are indicative, and should be used only for comparing between options rather than as best estimates of absolute peak outflows for a given AEP.

However, the results do show that:

- The chosen threshold for the target storage below FSL makes an appreciable difference to the modelled peak outflow frequencies for Lake Eppalock. For example, the 1% AEP peak outflow is approximately 20%, 40% or 60% lower than the base case depending on whether the target storage is 90%, 70% or 50% of FSL (Table 15).
- The influence of the increased outlet capacity is more obvious for the lower target storage options. That is, the distance between the solid in dashed lines for the 50% of FSL option in Figure 32 is greater than for the 90% option. This is because a greater volume of water needs to be released to reach lower target storages, and hence the increased outlet capacity reduces the proportion of time the storage volume is above the target storage (Figure 20).



- When comparing the options to reduce the target storage at Lake Eppalock to 70% of FSL using existing infrastructure, or with outlet capacity increased to 5,000 ML/d, and the option to add a spillway slot at 70% of FSL (Figure 33):
  - The difference between peak outflow frequencies is noticeable for outflows less than the moderate flood threshold (43,410 ML/d). The spillway slot results sit to the left of the 70% target storage options, and the current outlet capacity option is to the left of the increased outlet capacity option.
  - The differences between peak outflow frequencies is less significant for outflows greater than the moderate flood threshold.
- For peak outflows in the range of most interest to this study (i.e. flood AEPs that are more frequent than 1 in 10,000 and hence do not present a risk to dam safety), the peak outflows for the passive spillway slot and piano key spillways options are by coincidence quite similar (Figure 34), despite the differences in FSL and spillway ratings between the two options.
- The greatest increase in flood mitigation resulting from the addition of spillway gates is at the point when surcharge is maximised at 3.6 m (i.e. outflows are ~40,000 ML/d). During smaller floods (when the assumed surcharge is less) or larger floods (when spillway gates are fully opened), the peak outflow flood frequencies are more similar to the passive spillway slot and piano key spillways options (Figure 34).

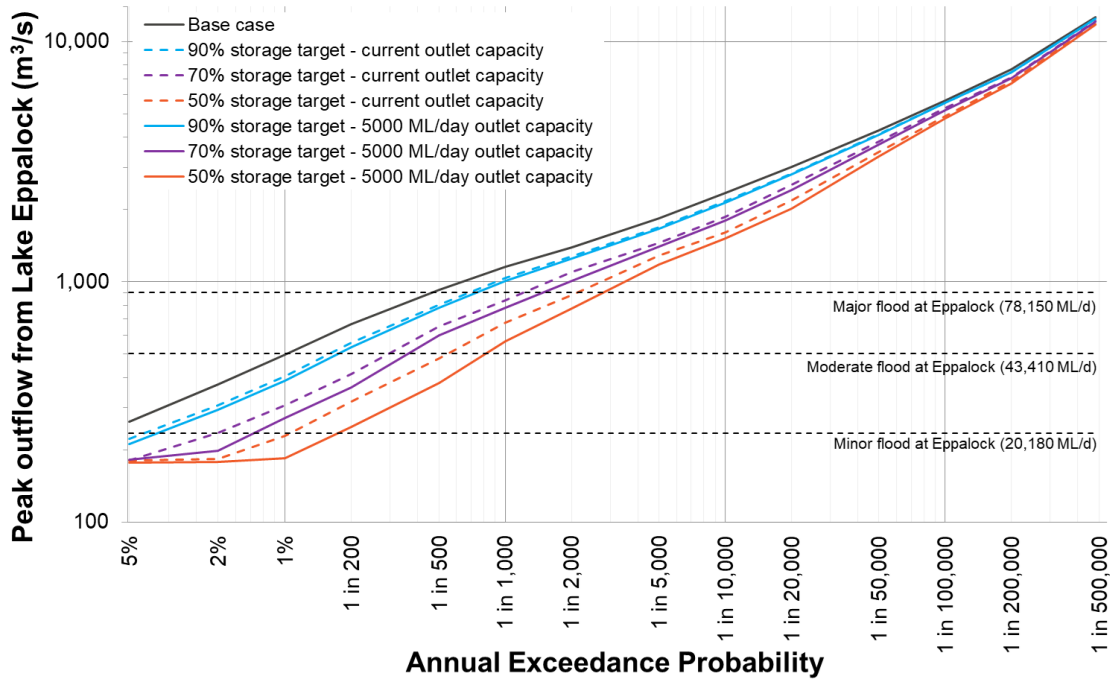

Figure 32: RORB model estimates of Lake Eppalock peak outflow AEPs for the options that involve a target storage of 50%, 70% or 90% of FSL, with either the existing outlet capacity or outlet capacity increased to 5,000 ML/d

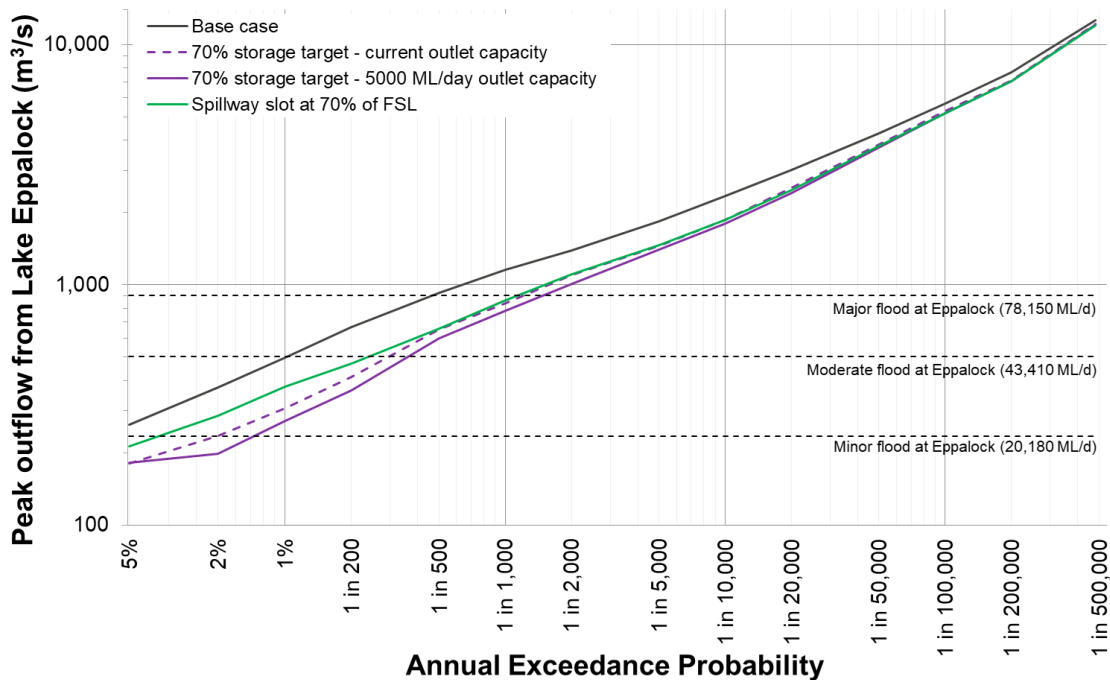

Figure 33: RORB model estimates of Lake Eppalock peak outflow AEPs for the options to reduce the target storage at Lake Eppalock to 70% of FSL using existing infrastructure, or with outlet capacity increased to 5,000 ML/d, or to add a spillway slot at 70% of current FSL

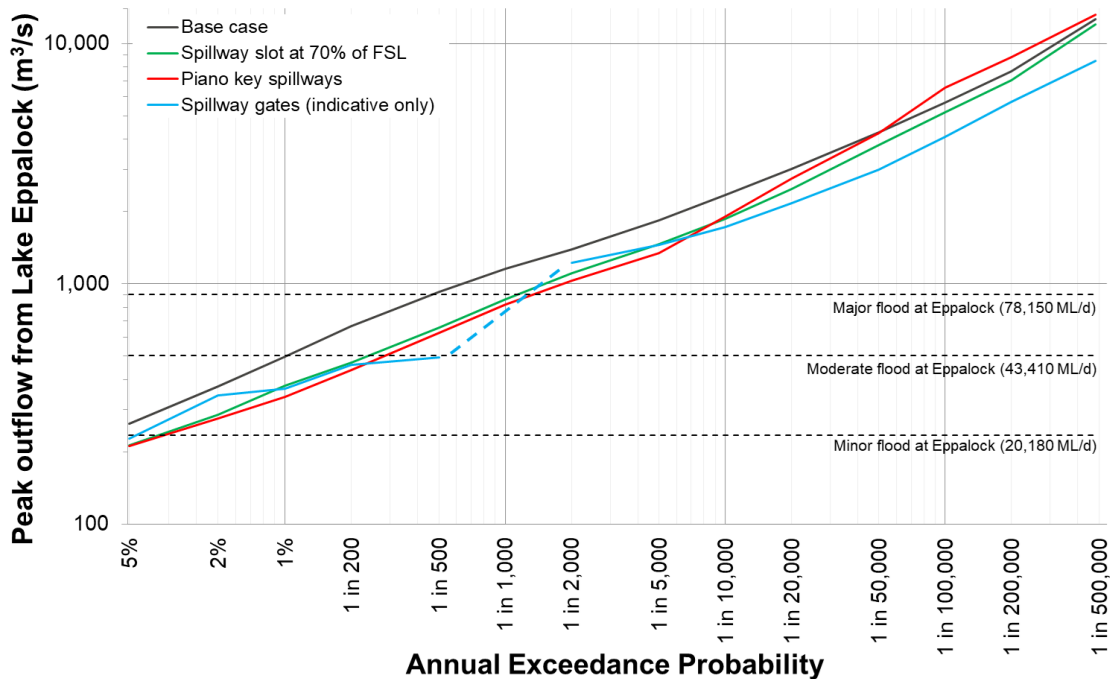

Figure 34: RORB model estimates of Lake Eppalock peak outflow AEPs for the options to add a spillway slot at 70% of current FSL, add spillway gates, or install piano key spillways on the primary and secondary spillways (and an erodible crest on the tertiary spillway)

Table 15: Estimated 5% (1 in 20), 1% (1 in 100) and 0.2% (1 in 500) AEP peak outflows from Lake Eppalock. These numbers are indicative, and should be used only for comparison between options rather than as best estimates of absolute peak outflows.

Option	5% AEP peak outflow (minor flood in base case)			1% AEP peak outflow (mod. flood in base case)			0.2% AEP peak outflow (major flood in base case)		
	m³/s	ML/d	Difference	m³/s	ML/d	Difference	m³/s	ML/d	Difference
<b>Base case</b>	*260	<b>*22,700</b>	-	*500	<b>*43,000</b>	-	*930	<b>*80,000</b>	-
90% target storage	220	19,200	-15%	400	34,900	-20%	800	69,300	-13%
90% target storage + 5,000 ML/d outlet	210	18,300	-20%	390	33,500	-20%	780	67,500	-16%
Slot spillway at 70% FSL	210	18,300	-20%	380	32,500	-25%	660	56,900	-30%
Spillway gates	230	20,000	-15%	370	31,700	-25%	490	42,600	-50%
Piano key spillways	210	18,300	-20%	340	29,200	-30%	630	54,200	-33%
70% target storage	180	15,600	-30%	310	26,500	-40%	650	56,400	-30%
70% target storage + 5,000 ML/d outlet	180	15,600	-30%	270	23,500	-45%	600	51,600	-35%
50% target storage	180	15,600	-30%	230	19,800	-55%	480	41,500	-50%
50% target storage + 5,000 ML/d outlet	180	15,600	-30%	180	15,900	-65%	380	32,800	-60%

\* These values are lower than quoted by HARC (2017) for the associated AEP, because the base case Lake Eppalock drawdown distribution provided by DEECA for this study differs to the drawdown distribution used by HARC (2017)





Table 16: Estimated AEPs for peak outflows from Lake Eppalock that reach the minor, moderate and major flood thresholds for the Campaspe River at Eppalock (406207). These numbers are indicative, and should be used only for comparison between options rather than as best estimates.

Option	Approximate AEP (1 in X) of outflow at flood class		
	Minor	Moderate	Major
Base case	<20	100	460
90% target storage	<20	160	670
90% target storage + 5,000 ML/d outlet	30	170	730
Slot spillway at 70% FSL	30	230	1,100
Spillway gates	20	660	1,200
Piano key spillways	30	270	1,300
70% target storage	50	280	1,200
70% target storage + 5,000 ML/d outlet	70	340	1,500
50% target storage	100	540	2,100
50% target storage + 5,000 ML/d outlet	170	790	2,700

## 6.5 Sensitivity testing using the SGEFM in place of the GSM

Given the influence of the Lake Eppalock drawdown distribution on modelled flood frequencies, and the observation that the GSM predictions sit below recent historical records (Figure 15), the options described in Section 4 were also modelled in RORB but with Stochastic Goulburn Environmental Flow Model (SGEFM) instead of GSM estimates of the Lake Eppalock storage traces. The SGEFM, developed by the University of Melbourne (John, 2021), was used primarily to assess expected changes to the daily flow regime downstream of Lake Eppalock (Section 10), but it can produce time-series of modelled storage volumes under historic climate conditions for the period 1941 – 2021 (Figure 35), and this provided an opportunity to sensitivity test the results included in Section 6.4.

Table 17 and Table 18 are a repeat of Table 15 and Table 16 in Section 6.4, but show RORB model results from the simulations where the Lake Eppalock drawdown distributions (i.e. Figure 20 and Figure 21) were from the SGEFM rather than GSM. Comparing Table 17 and Table 18 to Table 15 and Table 16 demonstrates that:

- The RORB model estimates of peak outflow from Lake Eppalock for a given AEP are higher when the drawdown distributions are taken from the SGEFM instead of the GSM. This is because the SGEFM estimates of the volume stored in Lake Eppalock under long-term historic climate conditions generally sit above the GSM (Figure 35).
- Although the *absolute* magnitudes for the peak outflow estimates in Table 17 are higher than in Table 15, the *relative* differences between the base case and options modelled are similar. Therefore, the degree to which each option is anticipated to increase the flood mitigation provided by Lake Eppalock is not particularly sensitive to whether the storage drawdown distribution is modelled using the GSM or SGEFM.

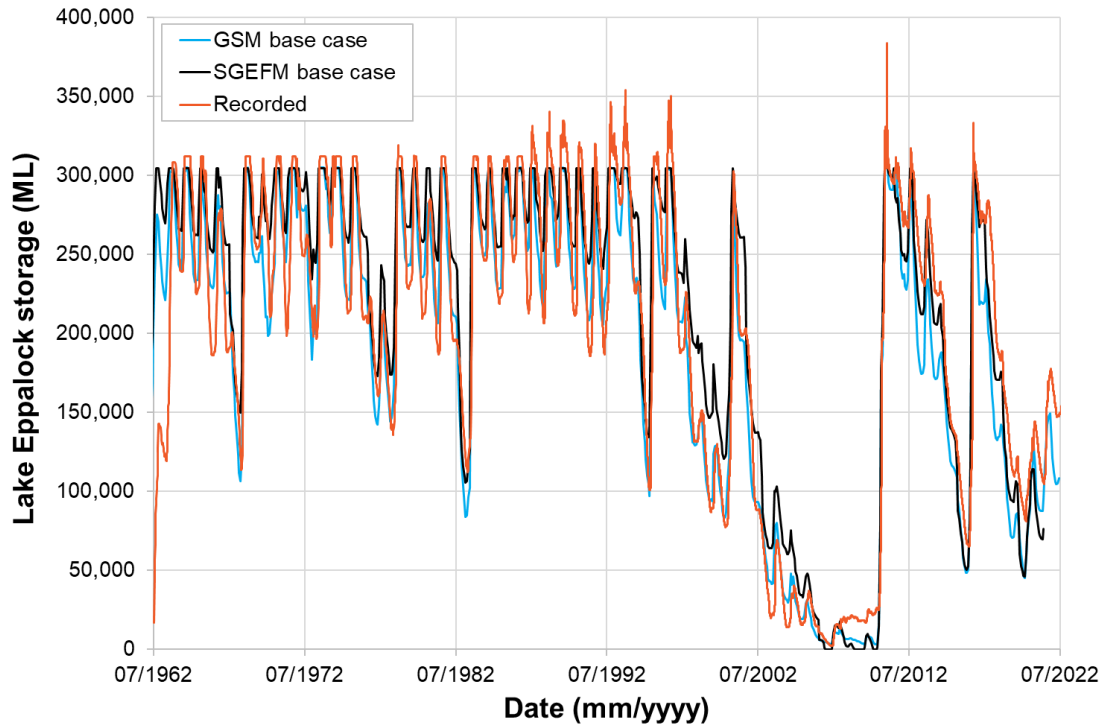

Figure 35: A comparison between the Lake Eppalock storage trace as recorded over time, and modelled in the GSM base case and SGEFM base case

Table 17: Estimated 5% (1 in 20), 1% (1 in 100) and 0.2% (1 in 500) AEP peak outflows from Lake Eppalock, but with the Lake Eppalock drawdown distribution modelled using the SGEFM instead of GSM. These numbers are indicative, and should be used only for comparison between options rather than as best estimates of absolute peak outflows.

Option	5% AEP peak outflow			1% AEP peak outflow			0.2% AEP peak outflow		
	m <sup>3</sup> /s	ML/d	Difference	m <sup>3</sup> /s	ML/d	Difference	m <sup>3</sup> /s	ML/d	Difference
Base case	310	26,800	-	580	50,500	-	1020	88,200	-
90% target storage	250	21,400	-20%	470	40,200	-20%	880	76,100	-15%
90% target storage + 5,000 ML/d outlet	230	20,000	-25%	420	36,500	-30%	830	71,700	-20%
Slot spillway at 70% FSL	240	21,000	-20%	430	37,200	-25%	750	64,500	-25%
Spillway gates	235	20,300	-25%	350	30,400	-40%	480	41,600	-50%
Piano key spillways	240	21,000	-20%	380	32,800	-35%	730	63,000	-30%
70% target storage	180	15,600	-40%	320	27,900	-45%	690	59,500	-35%
70% target storage + 5,000 ML/d outlet	180	15,600	-40%	290	24,800	-50%	630	54,400	-40%
50% target storage	180	15,600	-40%	250	21,300	-60%	510	44,300	-50%
50% target storage + 5,000 ML/d outlet	180	15,600	-40%	185	16,000	-65%	400	34,300	-60%



Table 18: Estimated AEPs for peak outflows from Lake Eppalock that reach the minor, moderate and major flood thresholds for the Campaspe River at Eppalock (406207), but with the Lake Eppalock drawdown distribution modelled using the SGEFM instead of GSM. These numbers are indicative, and should be used only for comparison between options rather than as best estimates.

Option	Approximate AEP (1 in X) of outflow at flood class		
	Minor	Moderate	Major
Base case	<20	70	330
90% target storage	20	120	540
90% target storage + 5,000 ML/d outlet	20	140	620
Slot spillway at 70% FSL	20	160	830
Spillway gates	20	510	1,300
Piano key spillways	20	170	920
70% target storage	40	260	1,050
70% target storage + 5,000 ML/d outlet	60	310	1,300
50% target storage	80	470	1,900
50% target storage + 5,000 ML/d outlet	170	740	2,500

The results presented in Section 6.4 and Section 6.5 are based on the joint probability framework shown in Figure 24, which involves many thousands of simulations. However, the relative performance of each option in terms of providing additional flood mitigation at Lake Eppalock will vary by individual event. Section 7 therefore assesses what differences each option may have made to outflows from Lake Eppalock if they were in place for the January 2011 and October 2022 floods

## 7. The 2011 and 2022 floods

### 7.1 Historical information

In January 2011, significant depths of rain fell across a large portion of Victoria in the week ending 15 January, including in the Campaspe River catchment (Figure 36). Conditions preceding the event were not particularly wet in terms of soil moisture (Figure 37), but inflows to Lake Eppalock were the largest on record to that time (Figure 38).

Although Lake Eppalock was full at the time of the January 2011 flood, the storage still provided flood mitigation. This is because the level in a reservoir with fixed crest spillways, like Lake Eppalock, will rise above FSL as inflows increase and spills commence. The volume of water stored behind the dam embankment and the corresponding outflow through the spillway will continue to increase until inflows begin to recede. At the point where the receding inflow is equal to outflow, the storage will have reached its maximum volume, level and outflow for the event. When outflows from Lake Eppalock peaked in the January 2011 flood, the volume in storage was 86,000 ML above the FSL volume (GMW, 2011). This temporarily stored water then drained from the storage as the peak passed and the reservoir returned to FSL. By operating in this manner, the peak inflow of approximately 140,000 ML/d was attenuated by Lake Eppalock, such that the peak outflow was approximately 70,000 ML/d<sup>26</sup>.

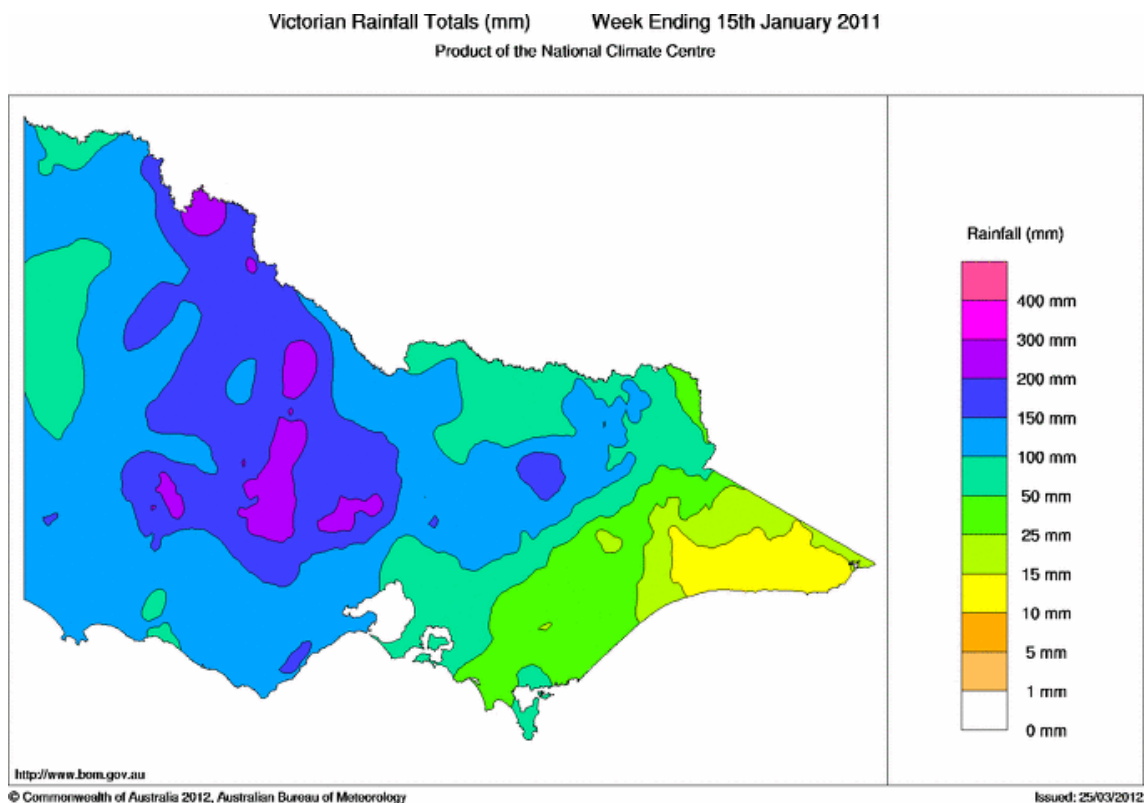

Figure 36: Victorian rainfall totals in the week ending 15/01/2011; [www.bom.gov.au/](http://www.bom.gov.au/)

<sup>26</sup> Revised from an initial estimate of 81,000 ML/d, following a SKM (2012b) update of the spillway ratings  
VIC00115\_R\_LakeEppalock-FloodMitigation-FinalForWeb

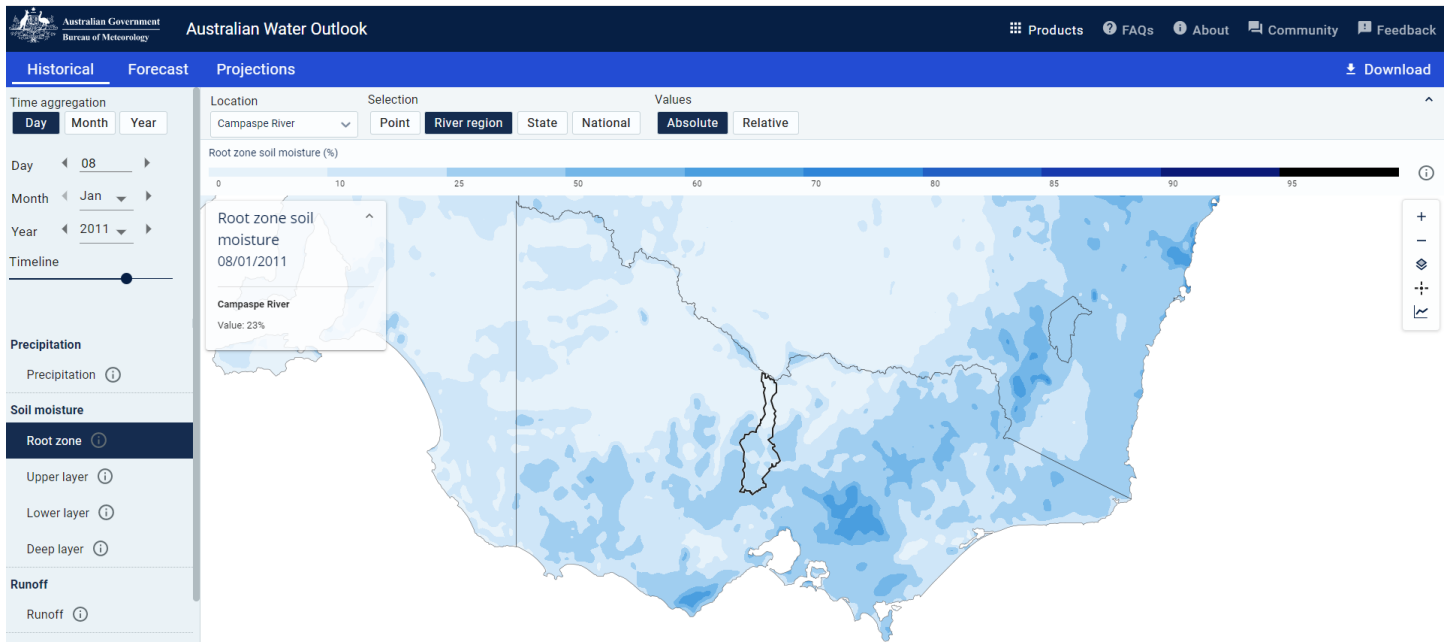

Figure 37: Root zone soil moisture estimates for Victoria on 08/01/2011; [www.bom.gov.au](http://www.bom.gov.au)

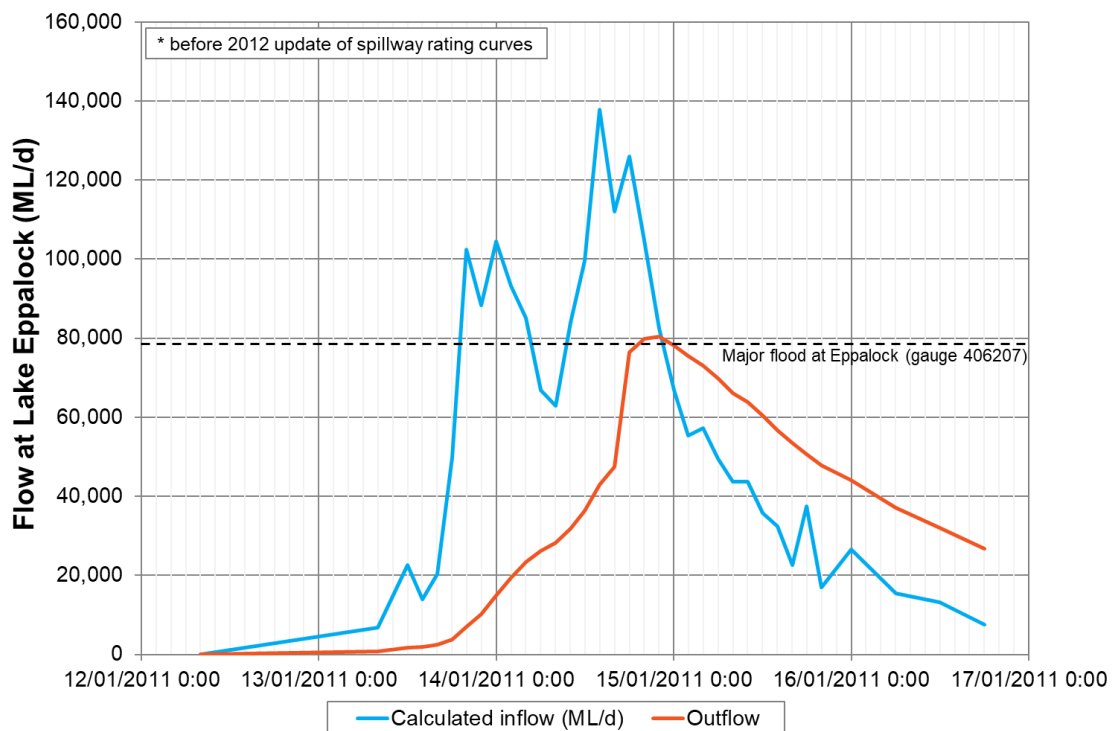

Figure 38: GMW records of outflow and calculated inflow for Lake Eppalock during the January 2011 flood. After the event, which was the first time the secondary spillway operated, the rating curves were re-modelled (SKM, 2012b). The 2012 update of the spillway rating curves resulted in the estimated peak flow being revised to approximately 70,000 ML/d.



In the week preceding the October 2022 flood, rainfall depths in the Campaspe River catchment were less than during the January 2011 flood (Figure 39). However, the catchment was particularly wet at the time (Figure 40). The peak inflow to and outflow from Lake Eppalock were again the largest on record (Figure 41).

Victorian Rainfall Totals (mm) Week Ending 15th October 2022  
Australian Bureau of Meteorology

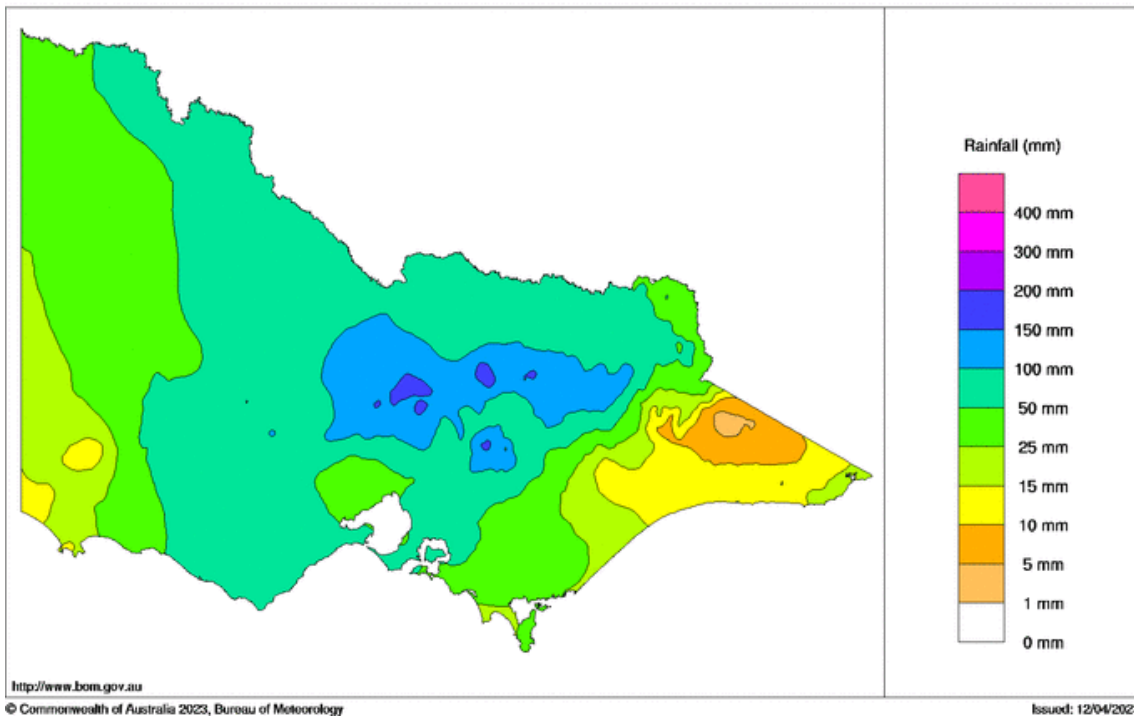

Figure 39: Victorian rainfall totals in the week ending 15/10/2022; [www.bom.gov.au/](http://www.bom.gov.au/)

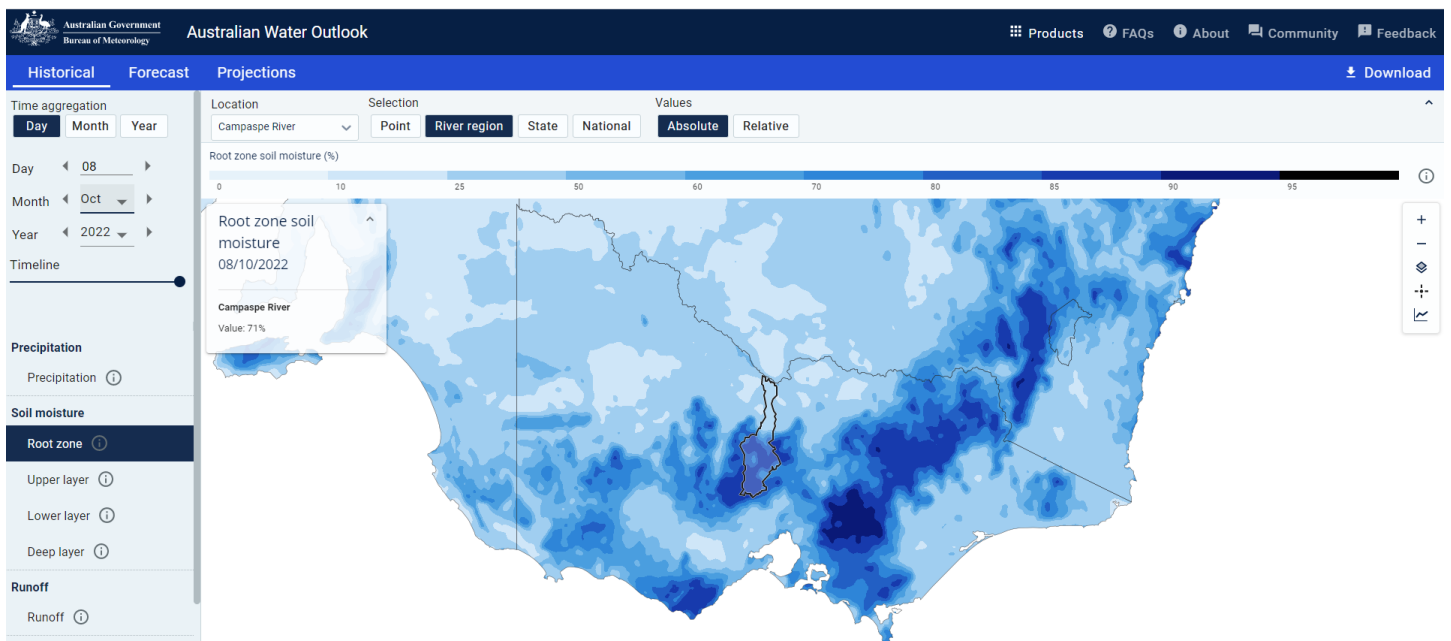

Figure 40: Root zone soil moisture estimates for Victoria on 08/10/2022; [www.bom.gov.au/](http://www.bom.gov.au/)

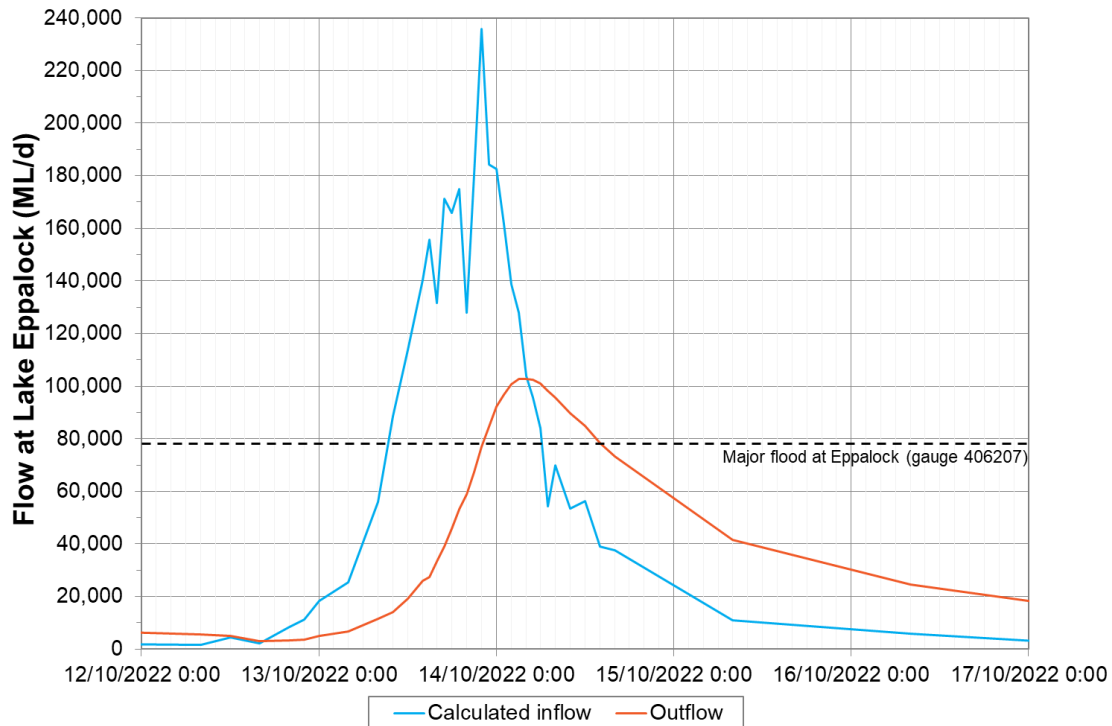

Figure 41: GMW records of outflow and calculated inflow for Lake Eppalock during the October 2022 flood

## 7.2 Potential changes if options were implemented

### 7.2.1 If existing outlet capacity was retained

Figure 42 plots the cumulative inflow to Lake Eppalock for the spring periods preceding the January 2011 flood and October 2022 flood (i.e. from 1 September). Also included in orange is the cumulative volume that could have been released from storage if the existing downstream outlet at Lake Eppalock was operating at capacity for the same period of time. What this shows is that even if the outlet had been used to the maximum degree possible, approximately 90,000 ML would have accumulated in storage before the 2011 flood and 120,000 ML before the October 2022 flood. In other words, the storage would still have filled to FSL prior to the floods if Lake Eppalock was at 70% capacity (~90,000 ML airspace) on 1 September 2010 and 60% of capacity (~120,000 ML airspace) on 1 September 2022 and downstream releases were 1,600 ML every day. In contrast, as shown by the grey line sitting above the blue line, if the outlet capacity at Lake Eppalock was 5,000 ML/d, the storage could have been held at target storage volumes below FSL in the lead-up to the January 2011 and October 2022 floods.

These examples suggest that:

- The differences that reducing the target storage using existing infrastructure will make to flood frequencies are overstated in Figure 32 and Table 16.
- Adopting a target storage of 70% or 90% below FSL using the existing infrastructure at Lake Eppalock would not have significantly changed the outcomes observed in January 2011 and October 2022.

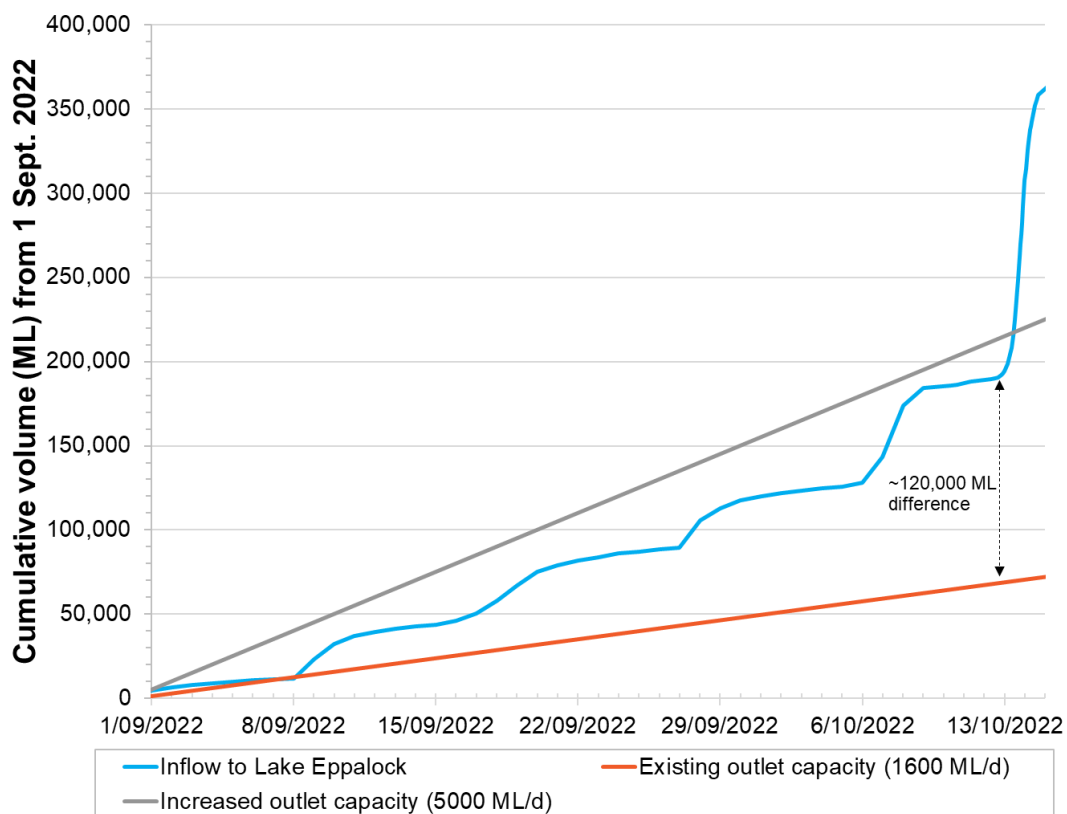
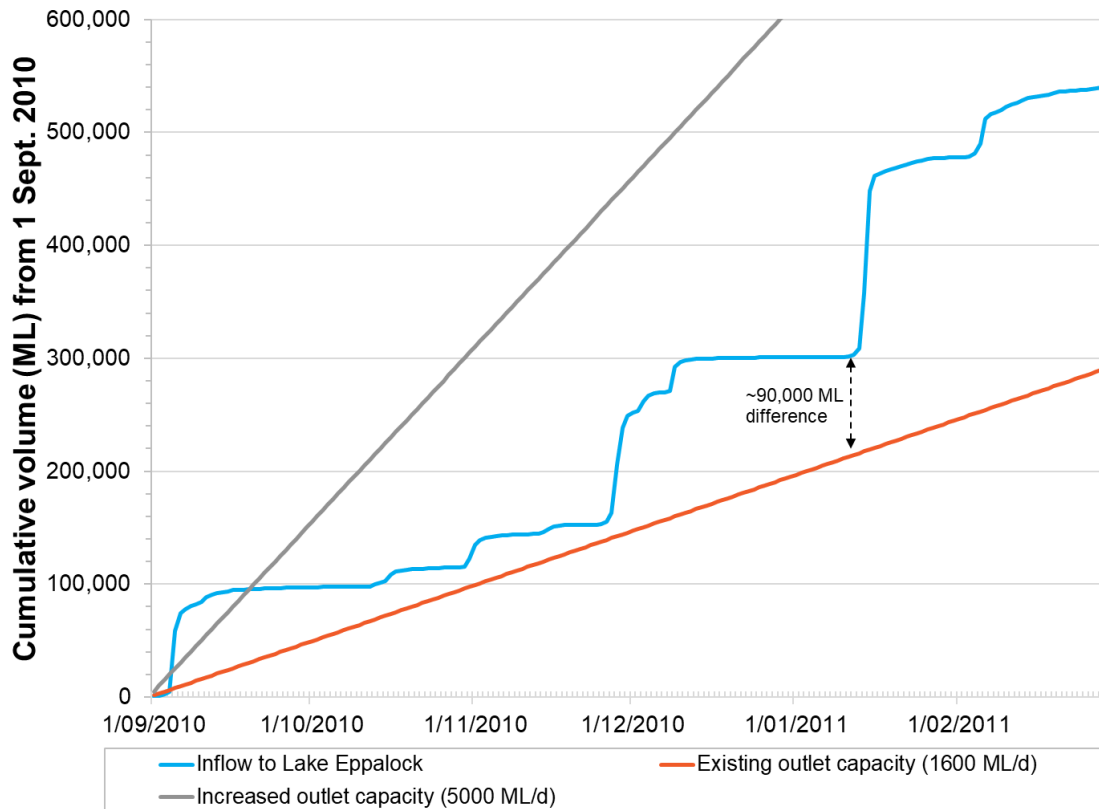

Figure 42: Cumulative inflows to Lake Eppalock preceding the January 2011 flood (top) and October (2022) flood, compared with existing outlet capacity and 5,000 ML/d outlet capacity





## 7.2.2 If pre-releases were made in response to forecasts

If spillway gates were used to make pre-releases from storage prior to floods – which would only be possible if the spillway crest was also lowered – approximately 2 weeks of releases at 10,000 ML/d would have been required to create the approximately 130,000 ML of airspace in Lake Eppalock needed to reduce the 2022 peak outflows from 100,000 ML/d to 40,000 ML/d. Section 6.2 describes how the values of 130,000 ML and 40,000 ML/d were derived.

Before pre-releasing, GMW needs to be confident that a) water released from storage will be replenished by inflows resulting from the forecast rainfall and b) releases will not exacerbate downstream flooding. This means that the rainfall and streamflow quantities and locations need to be estimated or known with a high degree of certainty. However, a 2-week foresight of inflows to Lake Eppalock and downstream tributaries that has sufficient certainty to enable pre-releases for this length of time is not available because:

- Forecasts of total rainfall are available for eight days at most<sup>27</sup>, and the forecasts for days 5-8 are generally less reliable than for days 1-4<sup>28</sup>
- Streamflow forecasts are available for periods of 7-days<sup>29</sup>, 1 month, 2 months or 3 months<sup>30</sup> but not for durations in between these time-steps
- Streamflow forecast skill in the Campaspe River reduces as the forecast period increases (Section 6.3)

For the 2011 flood, the amount of airspace that would have been required to reduce the peak outflow from approximately 70,000 ML/d to 40,000 ML/d would have been ~100,000 ML (i.e. approximately 10 days of pre-releases at 10,000 ML/d).

Uncertainties in forecasts of inflows to Lake Eppalock for lead times of 10-14 days will remain high unless there is a significant reduction in the uncertainty associated with rainfall forecasts. For example, Figure 43 shows the rainfall forecast on 10 October 2022 – 3 days before the October 2022 event began – from the two (of nine available) global deterministic models often given most weight in Bureau of Meteorology forecasts. Although the predicted rainfall totals are of a similar order of magnitude, the location of the heaviest rainfall is forecast to be in central Victoria in the Access (Australian) model and towards the north-east part of Victoria in the ECMWF (European) model. This variation in the predicted region of the heaviest rainfall makes it difficult to accurately predict streamflow at specific locations (e.g. inflows to Lake Eppalock).

This type of variation in the predicted location of the heaviest rainfall is also apparent within a given model. For example, the ECMWF (European) model can provide 50 ensemble predictions by varying the initial model conditions. Figure 44 shows the rainfall forecasts from two of the ensemble predictions, again 3 days before the October 2022 flood. Similar to what is observed in Figure 43, the predicted location of the heaviest rainfall is uncertain at that lead time.

---

<sup>27</sup> <http://www.bom.gov.au/jsp/watl/rainfall/pme.jsp>

<sup>28</sup> <http://www.bom.gov.au/watl/about/about-forecast-rainfall.shtml>

<sup>29</sup> <http://www.bom.gov.au/water/7daystreamflow/>

<sup>30</sup> <http://www.bom.gov.au/water/ssf/?ref=fr>

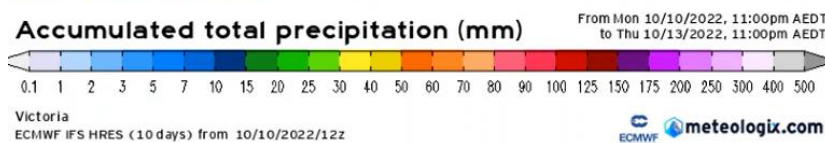
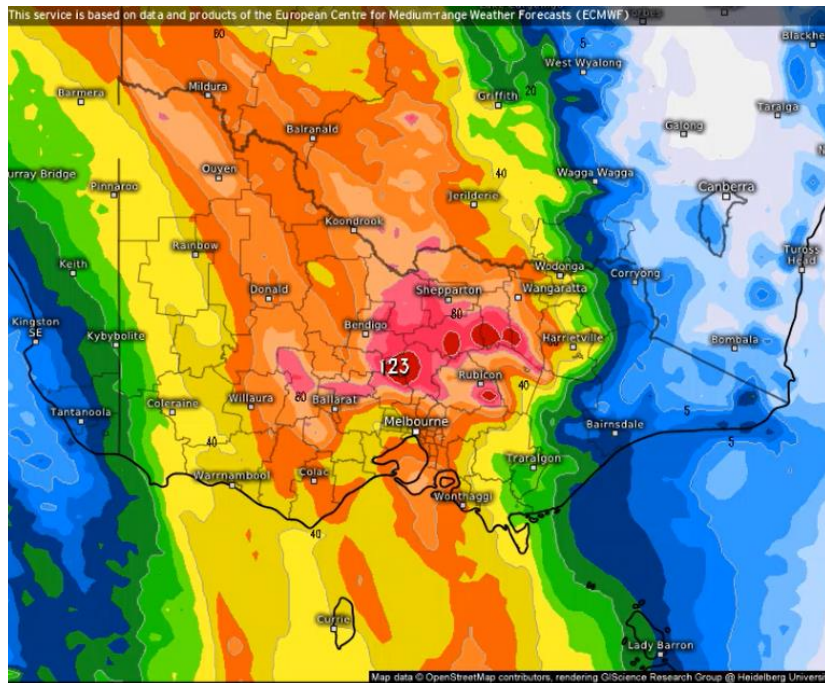
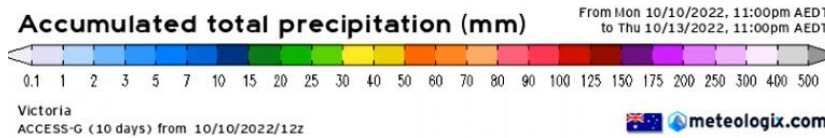
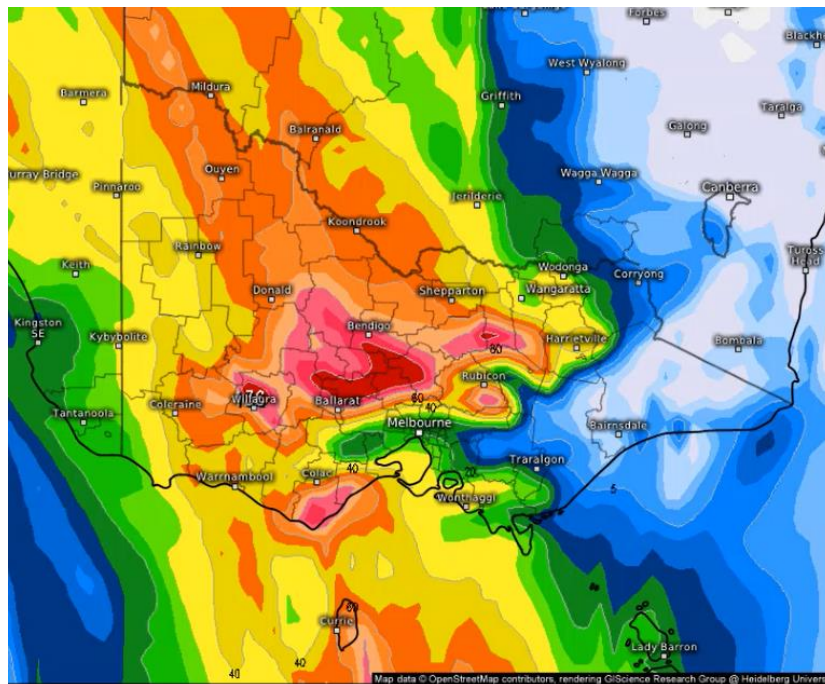

Figure 43: Rainfall forecasts prior to the October 2022 flood from two of the nine available global deterministic models (top: Access – Australia; bottom: ECMWF – Europe)

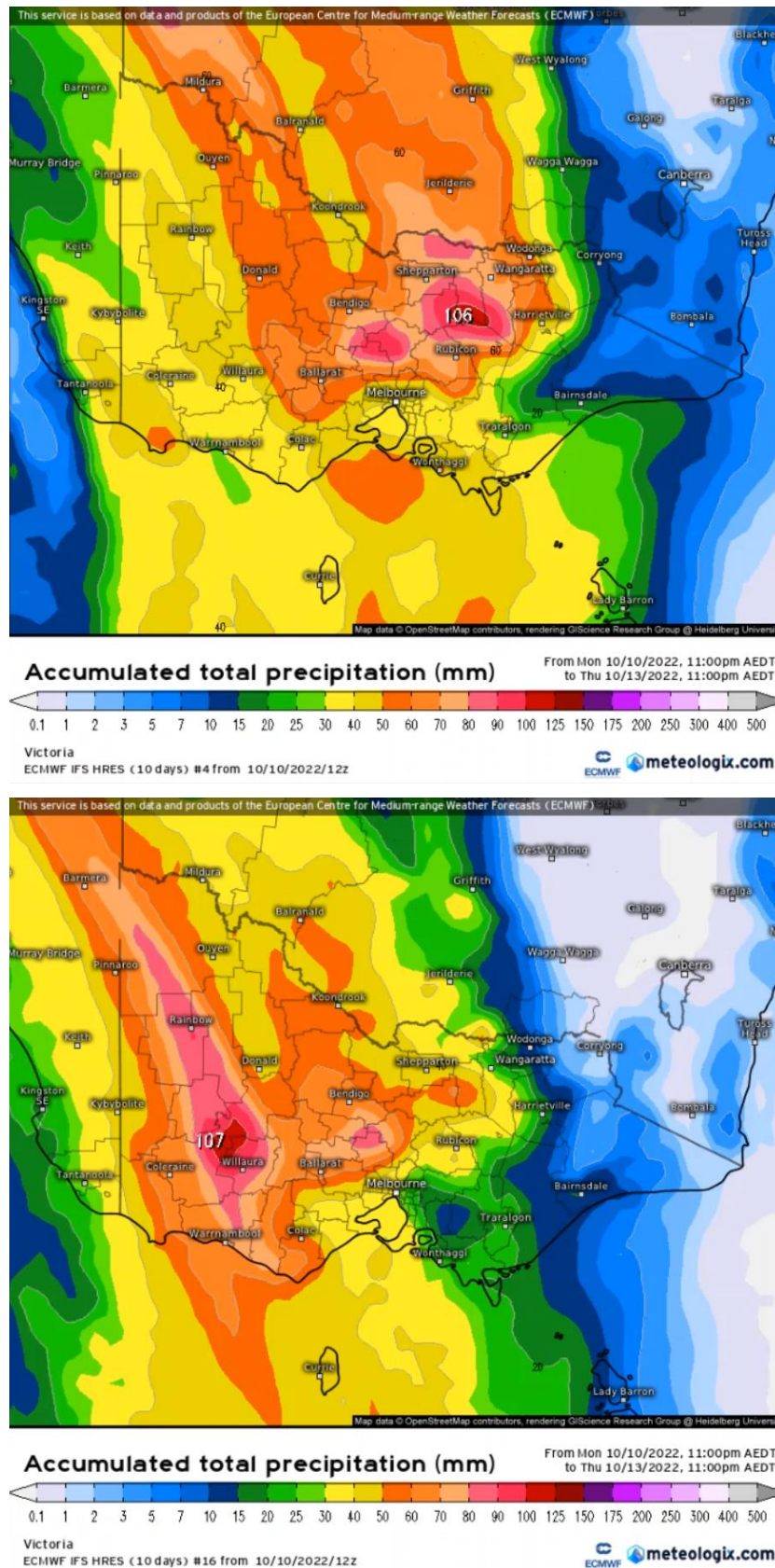

Figure 44: Rainfall forecasts prior to the October 2022 flood from two of the 50 ensemble predictions available from the ECMWF (European) model



This uncertainty in the predicted location of where rainfall will be heaviest will continue to constrain the degree to which storage operators can confidently make pre-releases in response to rainfall forecasts without either reducing the water available to entitlement holders or making downstream flooding worse.

### 7.2.3 If start storage was lower, or spillways modified

The single-event version of the RORB model calibrated by HARC (2017) to the January 2011 flood was used to assess what difference the other options in Section 4 may have made to the peak Lake Eppalock outflow had they been in place. To represent the options that involve a target storage of 90%, 70% or 50% of FSL and outlet capacity increased to 5,000 ML/d, the RORB model was run with a start storage at Lake Eppalock equivalent to 90%, 70% or 50% of FSL<sup>31</sup>. For the spillway slot, spillway gates and piano key spillway options, the RORB model was run using the modified spillway ratings in Section 6.2. Figure 45 shows the results of this exercise, in terms of modelled outflow (top) and Lake Eppalock reservoir level (bottom).

The degree to which the options reduce the peak of the January 2011 outflow from Lake Eppalock is somewhat different to those shown in Section 6. As the start storage becomes a lower percentage of FSL (90%, 70%, 50%), the outflow flood peak reduces. However, the peak flows for the spillway slot, spillway gates and piano key spillways options sit above the 90% target storage option, rather than near the 70% target storage option as per Figure 33 and Figure 34. This difference is likely to be because while an outlet capacity of 5,000 ML/d would have been sufficient to keep Lake Eppalock at a target below FSL in the lead-up to the 2011 flood (Figure 42), there are other times when the reservoir would have risen above the target FSL even with an increased outlet capacity (e.g. see mid-1970s and early 1980s in Figure 18).

For the slot spillway, spillway gates and piano key spillways options, the peak outflow in January 2011 is noticeably reduced but still predicted to have been near the moderate flood level at Eppalock. This in turn means the flooding in Rochester would probably have remained near or above the major flood threshold (Figure 10). Section 11 considers further the potential changes to flooding in Rochester if the options described in Section 4 were implemented.

The analysis described above was repeated for the October 2022 event, but using a simplified spreadsheet-based approach rather than the RORB model. This was required because the RORB model has not been calibrated to the 2022 flood. The results are shown in Figure 46. In this case, the degree to which the peak outflow from Lake Eppalock is reduced by the options considered is more similar to the rankings in Section 6. But only the spillway gates option, and the 50% or 70% of current FSL start-storage options would have reduced the Lake Eppalock peak outflow below the moderate flood threshold at Eppalock.

---

<sup>31</sup> This approach assumes that had the increased outlet capacity been available, it would have been used such that the reservoir level was at the target storage immediately prior to the flood.

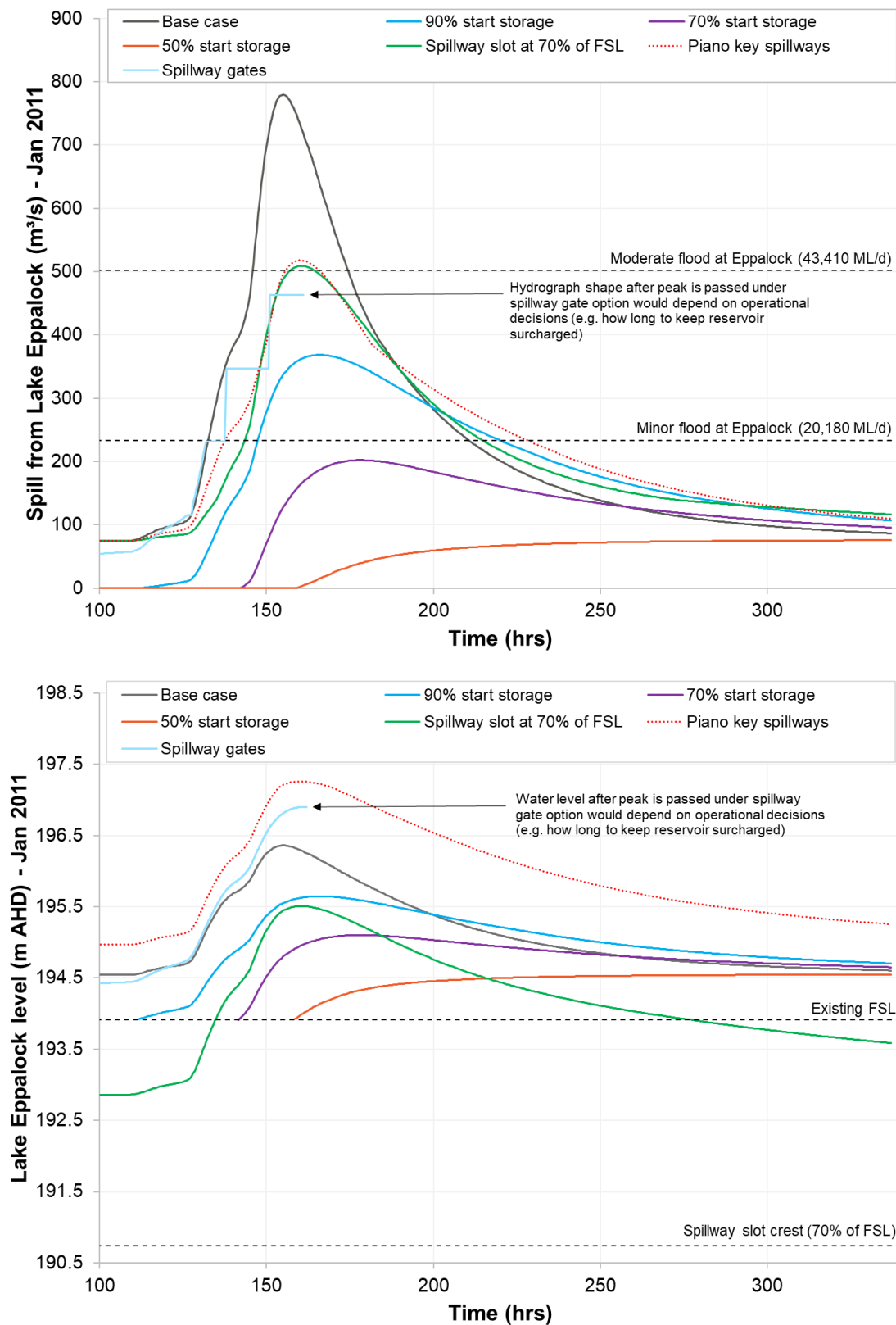

Figure 45: Modelled changes various options would make to the outflows from Lake Eppalock (top) and reservoir level (bottom) if the January 2011 flood were repeated. A 90%, 70% or 50% start storage would only have been achievable with an increased outlet capacity.

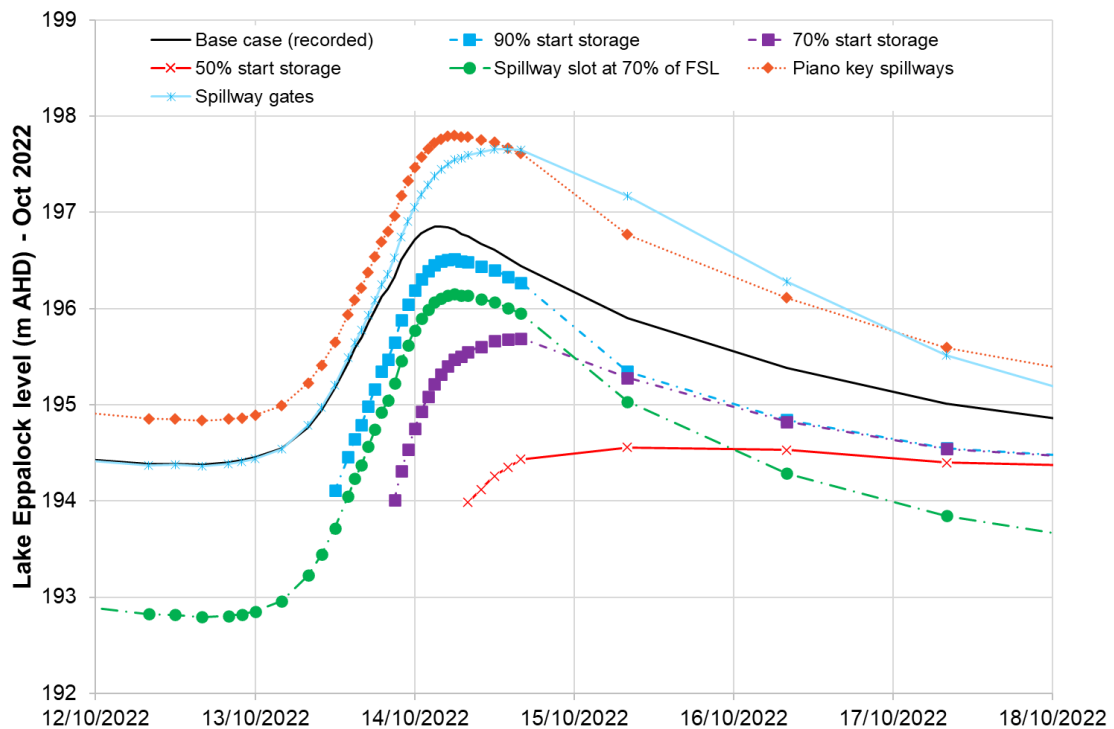
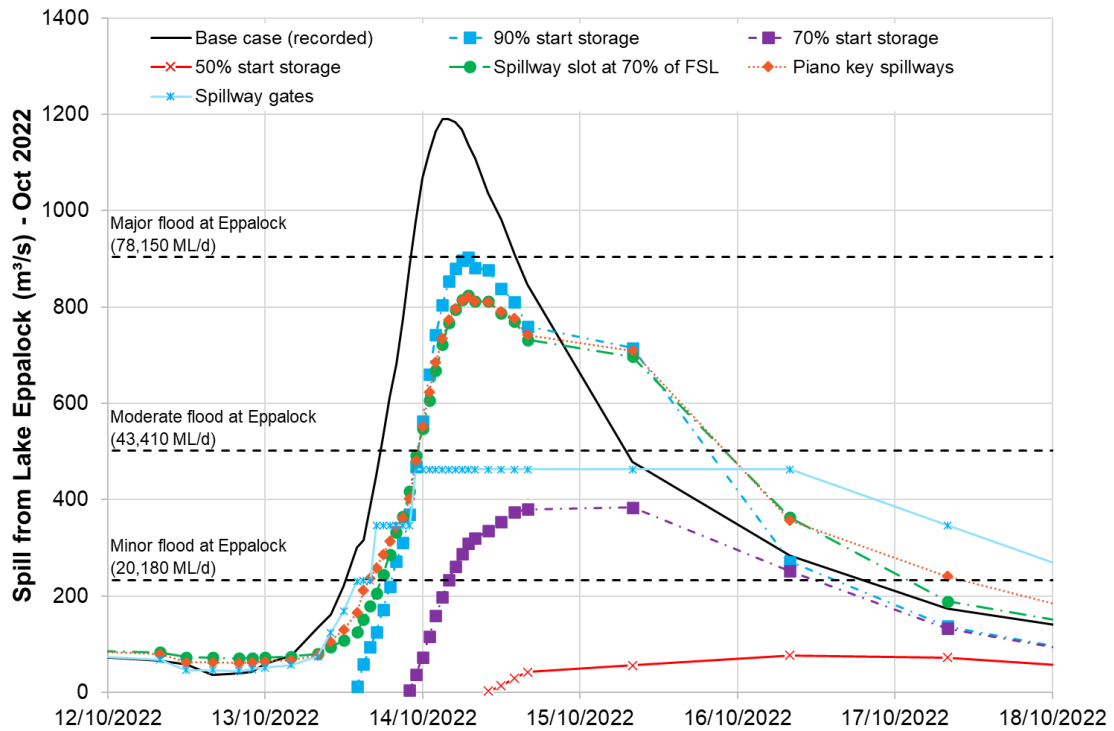

Figure 46: Modelled changes various options would make to the outflows from Lake Eppalock (top) and reservoir level (bottom) if the October 2022 flood were repeated. A 90%, 70% or 50% start storage would only have been achievable with an increased outlet capacity.



For the spillway gate option, the estimated reservoir level in the spreadsheet-based assessment of the 2022 flood (bottom of Figure 46) is approximately 100 mm above the 3.6 m surcharge limit adopted in Section 6.2. Therefore, a more detailed future assessment of this event (e.g. using a re-calibrated RORB model) may demonstrate that the design of the spillway gate option would need to enable reservoir surcharges slightly greater than 3.6 m to reduce peak outflows to the degree shown in Figure 46.

Figure 45 and Figure 46 also demonstrate that the degree to which each option considered will mitigate floods depends on the specific nature of the flood (e.g. peak, volume, sequencing), and the relative differences between options will therefore vary by event. For example, the 90% of FSL start storage option produces a lower peak than the spillway slot option in 2011, but not in 2022. This is because in a repeat of 2011, both options are predicted to produce a similar peak reservoir level (195.5 – 195.6 m AHD), which is below the existing secondary spillway crest of 195.74 m AHD. Therefore, based on Figure 26, the slot spillway option produces a higher outflow. In contrast, in the larger 2022 event the reservoir level for the 90% of FSL start storage option peaks at 196.5 m AHD and the 70% spillway slot option at 196.2 m AHD. This is approximately 0.8 m and 0.5 m respectively above the secondary spillway, and this difference in head over the secondary spillway means the 90% of FSL start storage option produces a higher outflow from Lake Eppalock.

The differences between the 70% target storage with increased outlet capacity option (represented by the 70% start storage hydrographs) and the spillway slot at 70% option are apparent in both Figure 45 and Figure 46. The spillway slot option produces a higher peak outflow from Lake Eppalock during these events because to pass more water downstream (compared with the base case) the reservoir level needs to rise above 70% of FSL to engage the spillway slot. In contrast, under the increased outlet capacity option, more water can be passed downstream regardless of the reservoir level. With 5,000 ML/d of outlet capacity, Lake Eppalock could theoretically have been held at 70% of the current FSL before the 2011 and 2022 floods arrived (Figure 42). Under the spillway slot option though, some of the inflows preceding the floods would have been passing through the slot. This means that for the 2011 and 2022 floods as modelled above, the starting reservoir level under the spillway slot option is higher compared with the increased outlet capacity option (as represented by the 70% start storage hydrographs). In turn, this results in a higher peak water level for the spillway slot option, and hence a larger peak outflow.



## 8. Concept designs and capital costs

### 8.1 Infrastructure options

Hunter Geotechnical and Wiltshire Consulting were engaged by HARC to develop concept designs and high-level capital cost estimates for the options that would involve infrastructure works at Lake Eppalock, namely:

- Increasing the outlet capacity to 5,000 ML/d
- Adding a passive spillway slot at 70% of current FSL
- Adding gates to the primary spillway, raising the secondary spillway and raising the dam embankment
- Adding piano keys to the primary and secondary spillways

Concept design drawings for each option are provided on the following pages, and a more complete set is included in Appendix C. The capital costs were estimated to a level commensurate with AACE Class 5<sup>32</sup>, which is appropriate for strategic planning and concept screening. AACE Class 5 estimates are typically within -50% to +100% of the true cost.

Some options will increase operation and maintenance activities (e.g. the increased outlet capacity and spillway gates options), and some options may involve complementary works (e.g. relocating or extending community and recreational facilities around Lake Eppalock). However, the estimation of these potential ongoing and associated costs was not within the scope of this technical assessment, and will need to be revisited in future.

#### 8.1.1 Increased outlet capacity

Increasing the outlet capacity at Lake Eppalock to 5,000 ML/d would involve:

- Constructing a temporary cofferdam near the right abutment so that water can be drained from the works area
- Tunnelling below the embankment (approximately 3.25 m diameter and 125 m long)
- Installing the outlet conduit (2.25 m diameter, mild steel epoxy lined) within the excavated tunnel, and encasing it in concrete
- Installing an intake tower with the necessary associated controls
- Constructing a valve house at the downstream end of the outlet
- Removing the cofferdam, and adding an approach channel to the Lake Eppalock bed that connects the deeper part of the reservoir to the base of the intake tower.

Figure 47 provides a plan and side view of the associated works, and Table 19 presents the indicative capital cost estimate for this option.

---

<sup>32</sup> [https://web.aacei.org/docs/default-source/toc/toc\\_69r-12.pdf](https://web.aacei.org/docs/default-source/toc/toc_69r-12.pdf)



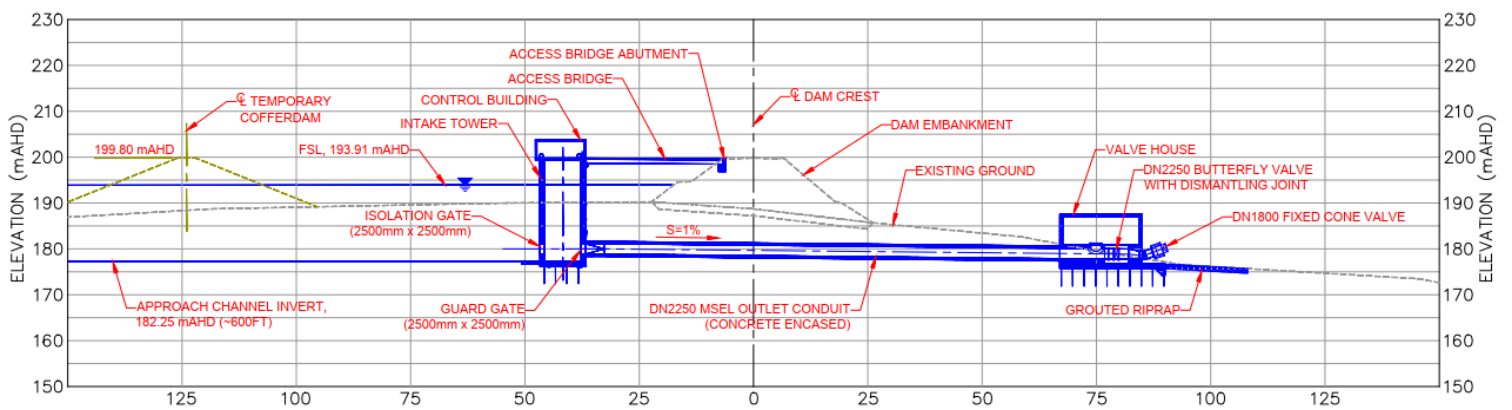
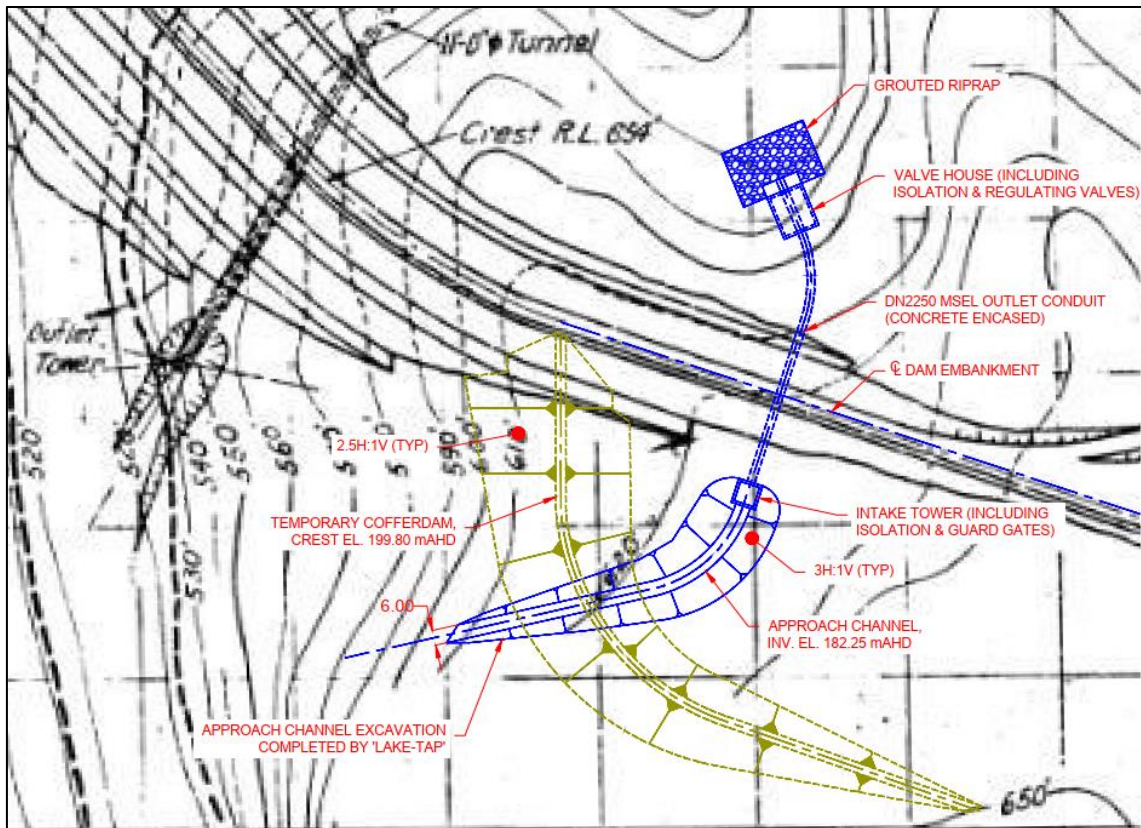

Figure 47: A plan view (top) and side view (bottom) of the infrastructure works required to increase the outlet capacity (at FSL) to 5,000 ML/d, by adding a second outlet with a capacity of 3,400 ML/d (at FSL)

Table 19: Indicative capital cost estimate for the option to increase the Lake Eppalock outlet capacity to 5,000 ML/d, but adding a second outlet with a capacity of 3,400 ML/d

Item	Description	Description		New Outlet Works	
		Units	Rate (\$)	Qty	Cost (\$)
1	Preliminaries				
1.01	Mgmt Plans, Works Procedures, Mob/Demob, etc.	-	10% DC	1	\$1,342,000
2	General Earthworks / Civil Works				
2.01	Temporary Cofferdam (Construction)	m <sup>3</sup>	\$25	54,300	\$1,357,500
2.02	Clearing & Grubbing	m <sup>2</sup>	\$6	6,000	\$36,000
2.03	Stripping / Stockpiling Topsoil	m <sup>3</sup>	\$10	900	\$9,000
2.04	Surface Excavation (Soil)	m <sup>3</sup>	\$20	2,100	\$42,000
2.05	Surface Excavation (Rock)	m <sup>3</sup>	\$50	18,900	\$945,000
2.06	Surface Excavation (Lake Tap) - Incl. Mucking Channel	LS	\$200,000	1	\$200,000
2.07	Tunnel Excavation (Rock) - Incl. Temp. Lining / Rock Bolts	m	\$20,000	125	\$2,500,000
2.08	Tunnel Permanent Lining - Incl. Steel Pipe / RC Encasement	m	\$10,000	125	\$1,250,000
2.09	Haul Excess Rock to Spoil (< 1 km)	m <sup>3</sup>	\$10	22,125	\$221,250
2.10	Temporary Cofferdam (Removal)	m <sup>3</sup>	\$10	54,300	\$543,000
3	Outlet Works				
3.01	Foundation Preparation	m <sup>2</sup>	\$8	425	\$3,400
3.02	Dental Concrete / Slush Grouting	m <sup>3</sup>	\$450	50	\$22,500
3.03	Intake Tower (Structural Concrete) - Incl. DCP Anchors	m <sup>3</sup>	\$2,500	810	\$2,025,000
3.04	Intake Tower (Control Building) - Incl. Gantry Crane	LS	\$75,000	1	\$75,000
3.05	Isolation Gate (2.5m x 2.5m) - Incl. Hoist / Controls	LS	\$50,000	1	\$50,000
3.06	Guard Gate (2.5m x 2.5m) - Incl. Hoist / Controls	LS	\$50,000	1	\$50,000
3.07	Access Bridge - Incl. RC Abutment	m <sup>2</sup>	\$5,500	120	\$660,000
3.08	Valve House (Structural Concrete) - Incl. DCP Anchors	m <sup>3</sup>	\$2,500	1,050	\$2,625,000
3.09	Isolation Valve (DN2250) - Butterfly Valve w. Dismantling Jt.	LS	\$200,000	1	\$200,000
3.10	Regulating Valve (DN1800) - Fixed Cone Valve	LS	\$400,000	1	\$400,000
3.11	Grouted Riprap	m <sup>3</sup>	\$150	730	\$109,500
4	Other Items				
4.01	Site Rehabilitation	LS	\$100,000	1	\$100,000
Total Direct Cost				-	\$14,766,150
Total Indirects, Design, Margin, Contingency, Etc.				100%	\$14,766,150
<b>TOTAL OUT-TURN COST</b>				-	<b>\$29,532,300</b>

### 8.1.2 Spillway slot

Adding a passive slot to the primary spillway at Lake Eppalock, with a crest level at 70% of the current FSL would require:

- Constructing a temporary cofferdam upstream of the existing spillway crest, so that the works area can be kept dry
- Removing part of the existing spillway
- Constructing a new spillway control structure and chute for the slot
- Anchoring the spillway slot control structure, chute slab and chute walls, and installing appropriate underdrains
- Removing the cofferdam, and adding an approach channel to the Lake Eppalock bed that connects the deeper part of the reservoir to spillway slot.

Figure 48 provides a plan, side and cross-section view of the associated works, and Table 20 presents the indicative capital cost estimate for this option.

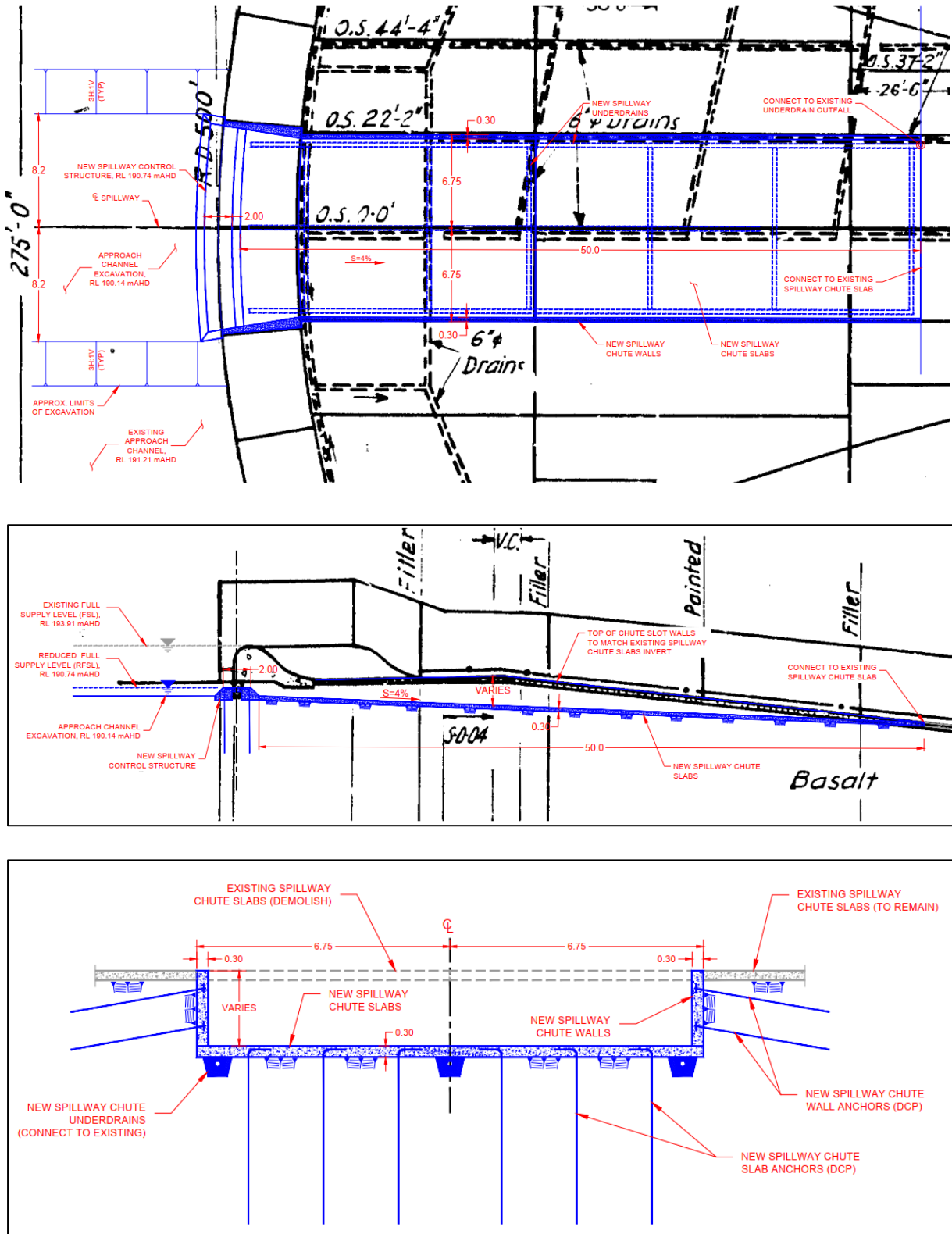

Figure 48: A plan view (top), side view (middle) and cross-section view (bottom) of the infrastructure works required to add a spillway slot at 70% of the current FSL

Table 20: Indicative capital cost estimate for the option to add a spillway slot at 70% of the current FSL

Item	Description	Description		Primary Spillway Cut	
		Units	Rate (\$)	Qty	Cost (\$)
1	Preliminaries				
1.01	Mgmt Plans, Works Procedures, Mob/Demob, etc.	-	10% DC	1	\$162,400
2	General Earthworks / Civil Works				
2.01	Temporary Cofferdam (Bulkheads)	LS	\$100,000	1	\$100,000
2.02	Spillway Demolition (Ogee)	m <sup>3</sup>	\$500	200	\$100,000
2.03	Spillway Demolition (Chute Slabs) - Incl. Sawcut	m <sup>3</sup>	\$500	140	\$70,000
2.04	Surface Excavation (Rock) - Incl. Mucking	m <sup>3</sup>	\$50	5,400	\$270,000
2.05	Haul Excess Rock to Spoil (< 1 km)	m <sup>3</sup>	\$10	5,740	\$57,400
2.06	Temporary Cofferdam (Removal)	LS	\$25,000	1	\$25,000
3	Primary Spillway				
3.01	Foundation Preparation	m <sup>2</sup>	\$8	710	\$5,680
3.02	Dental Concrete / Slush Grouting	m <sup>3</sup>	\$450	80	\$36,000
3.03	Underdrains - Incl. Pipe, Fixtures, Sand, Gravel	m	\$150	230	\$34,500
3.04	Spillway Control Structure (RC) - Incl. DCP Anchors	m <sup>3</sup>	\$2,500	40	\$100,000
3.05	Spillway Chute Slab (RC) - Incl. DCP Anchors, Waterstops	m <sup>3</sup>	\$2,500	210	\$525,000
3.06	Spillway Chute Walls (RC) - Incl. DCP Anchors, Waterstops	m <sup>3</sup>	\$2,500	100	\$250,000
4	Other Items				
4.01	Site Rehabilitation	LS	\$50,000	1	\$50,000
Total Direct Cost				-	\$1,785,980
Total Indirects, Design, Margin, Contingency, Etc.				100%	\$1,785,980
<b>TOTAL OUT-TURN COST</b>				-	<b>\$3,571,960</b>

### 8.1.3 Spillway gates

Infrastructure works associated with the spillway gate option would include:

- Removing aspects of the existing primary and secondary spillway structures
- Treating the primary spillway so that it can support the gates and associated controls
- Installing 10 gates on the primary spillway
- Raising the secondary spillway crest 3 m by constructing a new ogee spillway
- Building a parapet wall on the main embankment to raise the crest to 202.1 m AHD (2.3 m raise)
- Raising the existing secondary embankments to 202.1 m AHD (2.3 m – 2.6 m raise)
- Adding new embankments where the existing natural land or road surface around Lake Eppalock is < 202.1 m AHD.

For the reasons discussed in Section 6.3 and Section 7.2.2, the spillway gates were designed to sit on the existing crest, rather than extending below FSL and thus enabling pre-releases in response to rainfall forecast. This approach reduced the initial capital costs of the spillway gates option.

Figure 49 is a plan view showing the location of the various works, and Figure 50 contains a side view of the gate arrangements on the primary spillway and the new ogee crest on the secondary spillway. Drawings of the parapet wall, secondary embankment raise and new embankments are provided in Appendix C. Table 21 shows the indicative capital costs.

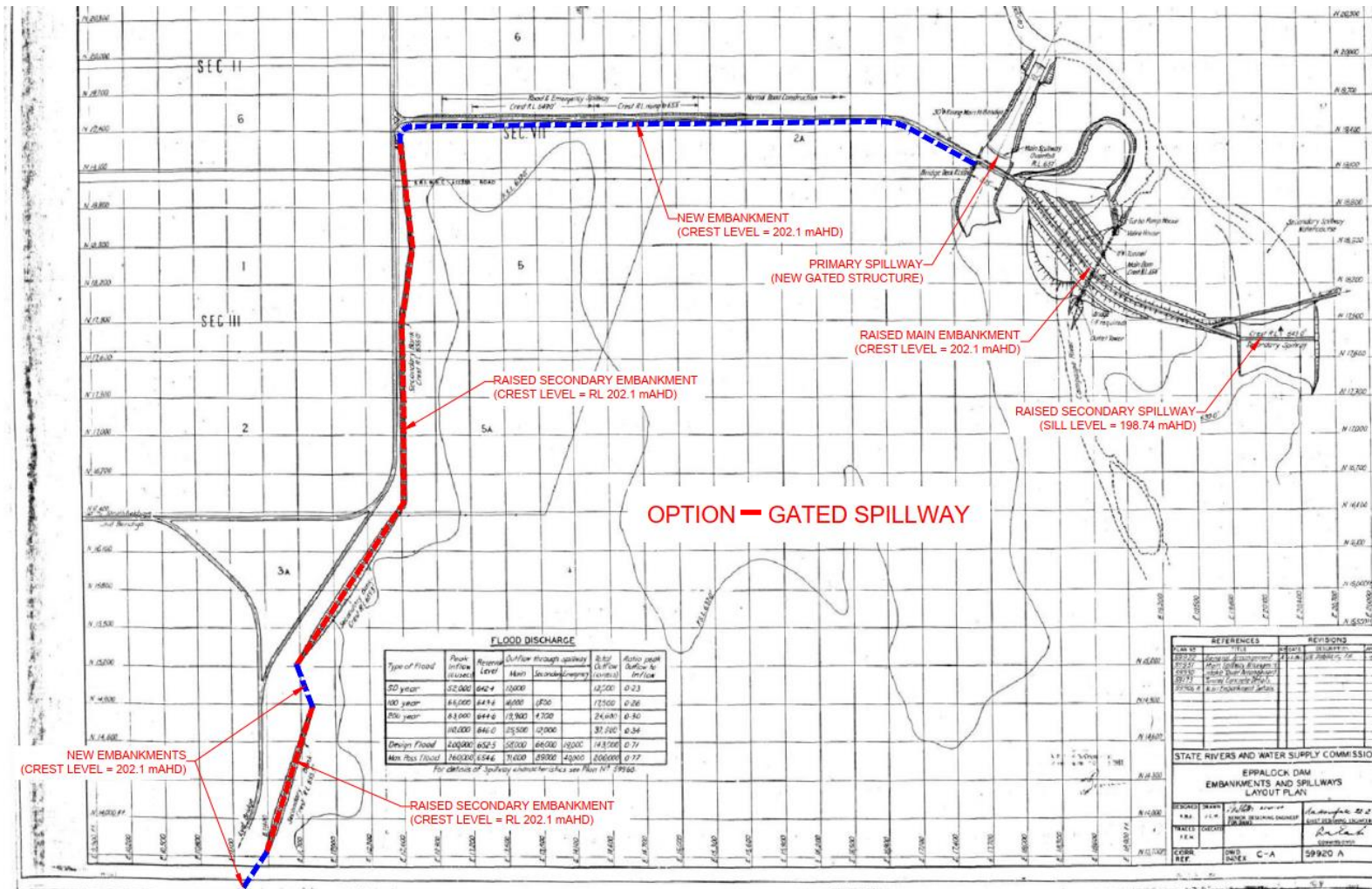

Figure 49: A plan view of the works associated with adding gates to the primary spillway at Lake Eppalock, so that a controlled reservoir surcharge of up to 3.6 m above FSL is possible during floods

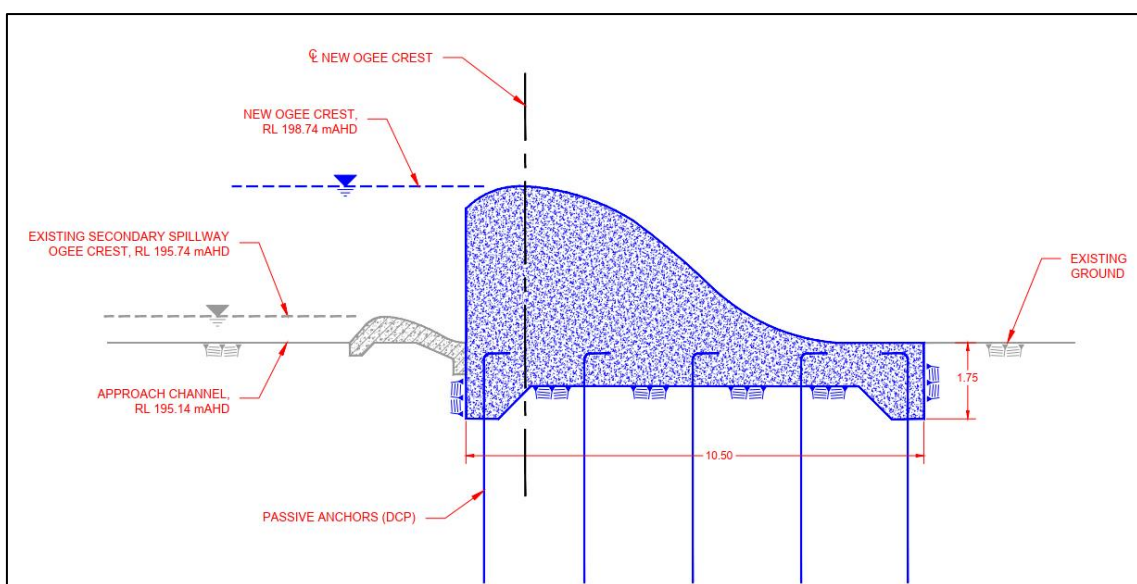
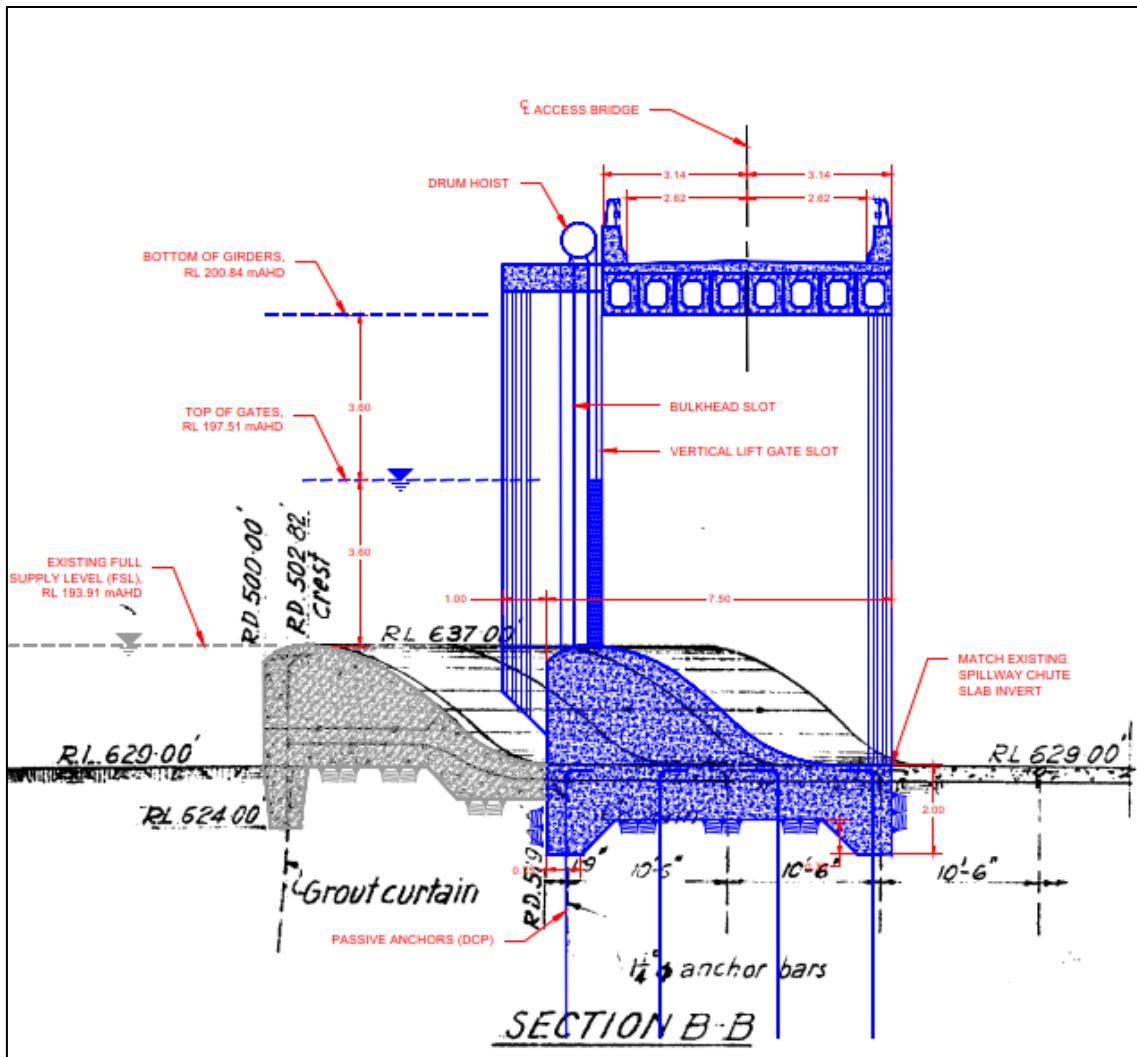

Figure 50: A side view of a gate on the primary spillway (top) and the new ogee crest on the secondary spillway (bottom)

Table 21: Indicative capital cost estimate for the spillway gates option

Item	Description	Description		Primary Spillway Gates	
		Units	Rate (\$)	Qty	Cost (\$)
1	Preliminaries				
1.01	Mgmt Plans, Works Procedures, Mob/Demob, etc.	-	10% DC	1	\$8,956,600
2	General Earthworks / Civil Works				
2.01	Spillway Demolition (Primary Chute Slabs) - Incl. Sawcut	m <sup>3</sup>	\$500	130	\$65,000
2.02	Spillway Demolition (Primary Abutments) - Incl. Sawcut	m <sup>3</sup>	\$500	70	\$35,000
2.03	Spillway Demolition (Secondary Abutments) - Incl. Sawcut	m <sup>3</sup>	\$500	20	\$10,000
2.04	Surface Excavation (Rock) - Primary	m <sup>3</sup>	\$50	610	\$30,500
2.05	Surface Excavation (Rock) - Secondary	m <sup>3</sup>	\$50	230	\$11,500
2.06	Haul Excess Rock to Spoil (< 1 km)	m <sup>3</sup>	\$10	1,060	\$10,600
3	Primary Spillway (Ogee / Gates)				
3.01	Foundation Preparation	m <sup>2</sup>	\$8	600	\$4,800
3.02	Dental Concrete / Slush Grouting	m <sup>3</sup>	\$450	60	\$27,000
3.03	Spillway Control Structure (RC) - Incl. DCP Anchors	m <sup>3</sup>	\$2,500	1,500	\$3,750,000
3.04	Spillway Piers (RC) - Incl. Gate Slots	m <sup>3</sup>	\$3,000	590	\$1,770,000
3.05	Spillway Abutments (RC)	m <sup>3</sup>	\$2,500	150	\$375,000
3.06	Spillway Bridge - Incl. Girders, Deck, Guardrails	m <sup>2</sup>	\$5,500	490	\$2,695,000
3.07	Spillway Gates (15T) - Incl. Hoist, Controls	ea	\$750,000	10	\$7,500,000
3.08	Spillway Bulkhead (Maintenance)	LS	\$500,000	1	\$500,000
3.09	Electrical to Spillway - Incl. Controls, Switchgear	LS	\$150,000	1	\$150,000
3.10	Backup Power (Generator) - Incl. Fuel Storage	LS	\$100,000	1	\$100,000
4	Secondary Spillway (Ogee)				
4.01	Foundation Preparation	m <sup>2</sup>	\$8	2,410	\$19,280
4.02	Dental Concrete / Slush Grouting	m <sup>3</sup>	\$450	250	\$112,500
4.03	Spillway Control Structure (RC) - Incl. DCP Anchors	m <sup>3</sup>	\$2,500	6,040	\$15,100,000
4.04	Spillway Approach / Training Walls	m <sup>3</sup>	\$2,500	520	\$1,300,000
4.05	Embankment Connections to Training Walls (Incl. Filters)	m <sup>3</sup>	\$120	5,000	\$600,000
5	Dam Embankment Raise				
5.01	Main Embankment - parapet wall raise	m	\$15,000	700	\$10,500,000
5.02	Secondary Embankment - raise existing (~ 90 m <sup>2</sup> /m)	m	\$16,000	1,800	\$28,800,000
5.03	New Embankments (~40 m <sup>2</sup> /m)	m	\$10,000	1,600	\$16,000,000
6	Other Items				
6.01	Site Rehabilitation	LS	\$100,000	1	\$100,000
Total Direct Cost				-	\$98,522,780
Total Indirects, Design, Margin, Contingency, Etc.				100%	\$98,522,780
<b>TOTAL OUT-TURN COST</b>				-	<b>\$197,045,560</b>

### 8.1.4 Piano key spillways

Infrastructure works associated with the spillway reconfiguration (i.e. piano keys spillway) option would include:

- Constructing a temporary cofferdam upstream of the primary spillway, so that the works area can be kept dry
- Removing aspects of the existing primary and secondary spillway structures
- Treating the primary and secondary spillways so they can support the piano keys
- Installing the piano keys, and anchoring them
- Adding an erodible fuse plug to the tertiary spillway, and raising low points along the existing secondary embankments so that the fuse plug performs as intended

Figure 51 is a plan view showing the location of these various works, and Figure 52 is a plan view of the piano key arrangements on the primary spillway and secondary spillway. Table 22 shows the indicative capital cost for this option.

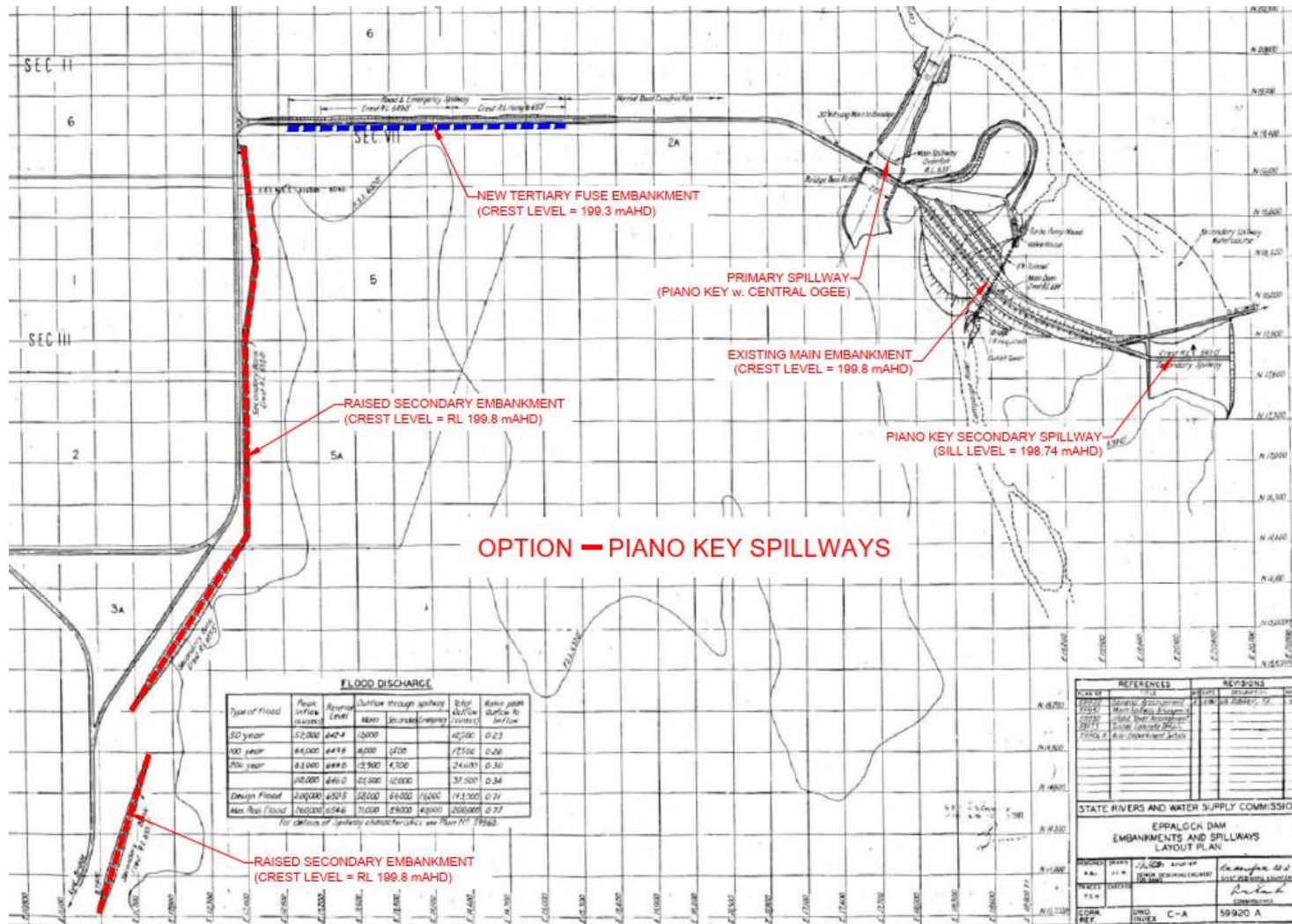

Figure 51: A plan view of the works associated with adding piano keys to the primary and secondary spillways at Lake Eppalock



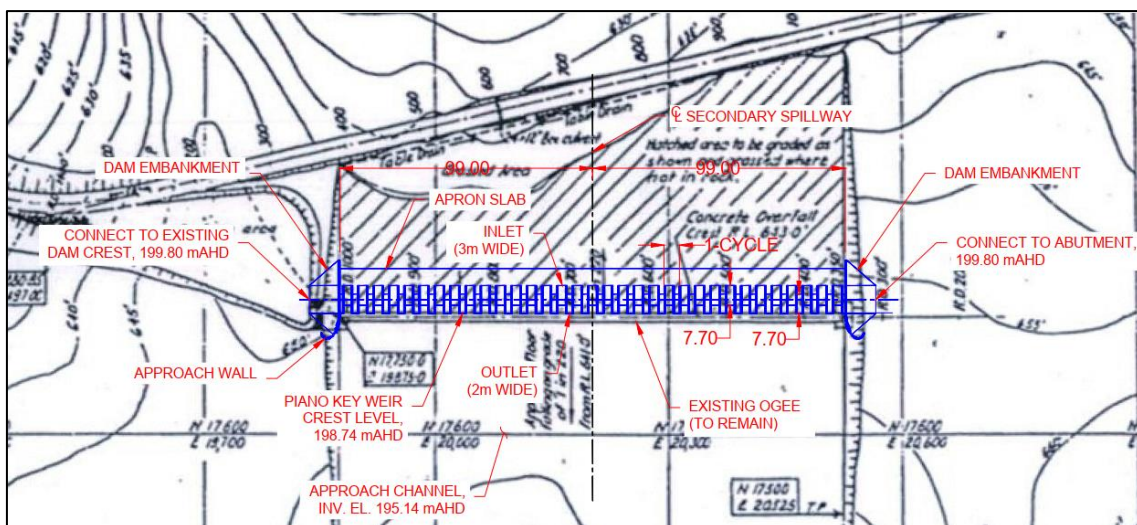
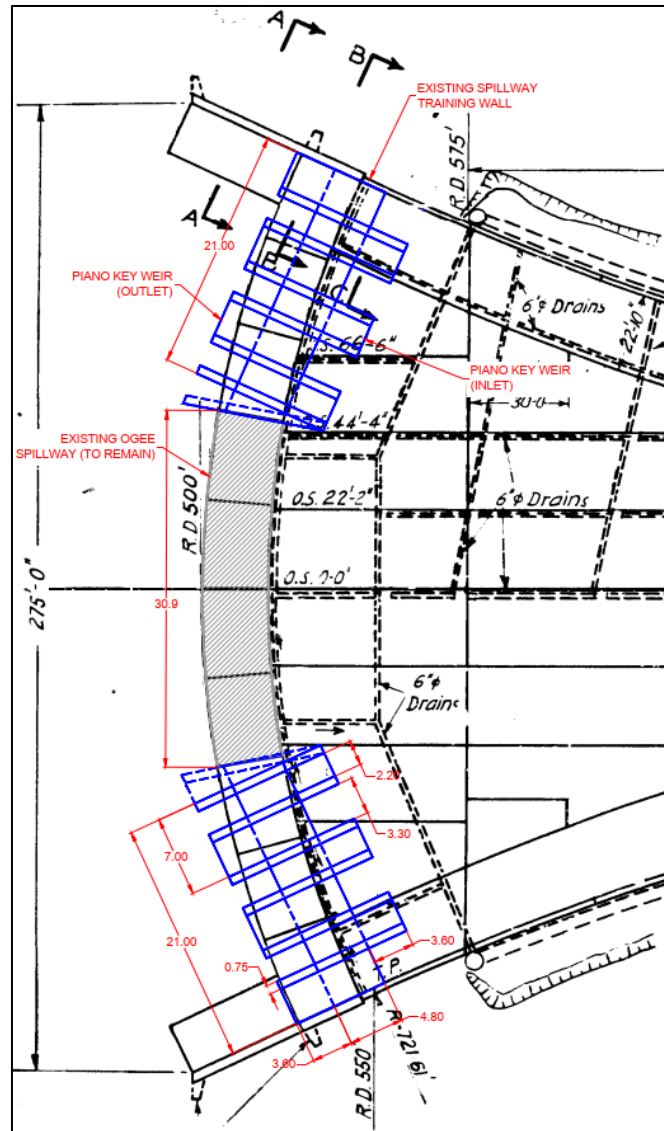

Figure 52: A plan view of the piano keys on the primary (top) and secondary (bottom) spillways



Table 22: Indicative capital cost estimate for the piano key spillways option

Item	Description	Description		Piano Key Spillways	
		Units	Rate (\$)	Qty	Cost (\$)
1	Preliminaries				
1.01	Mgmt Plans, Works Procedures, Mob/Demob, etc.	-	10% DC	1	\$2,558,340
2	General Earthworks / Civil Works				
2.01	Spillway Demolition (Primary_Chute Slabs) - Incl. Sawcut	m <sup>3</sup>	\$500	270	\$135,000
2.02	Spillway Demolition (Secondary_Abutments) - Incl. Sawcut	m <sup>3</sup>	\$500	20	\$10,000
2.03	Surface Excavation (Rock) - Primary	m <sup>3</sup>	\$50	330	\$16,500
2.04	Surface Excavation (Rock) - Secondary	m <sup>3</sup>	\$50	2,410	\$120,500
2.05	Haul Excess Rock to Spoil (< 1 km)	m <sup>3</sup>	\$10	3,030	\$30,300
3	Primary Spillway (PK Weir + Existing Ogee)				
3.01	Foundation Preparation	m <sup>2</sup>	\$8	400	\$3,200
3.02	Dental Concrete / Slush Grouting	m <sup>3</sup>	\$450	40	\$18,000
3.03	Spillway Piano Key Weir (RC) - Incl. DCP Anchors	m <sup>3</sup>	\$3,000	1,000	\$3,000,000
4	Secondary Spillway (PK Weir)				
4.01	Foundation Preparation	m <sup>2</sup>	\$8	3,300	\$26,400
4.02	Dental Concrete / Slush Grouting	m <sup>3</sup>	\$450	330	\$148,500
4.03	Spillway Piano Key Weir (RC) - Incl. DCP Anchors	m <sup>3</sup>	\$3,000	2,800	\$8,400,000
4.04	Spillway Apron Slab (RC) - Incl. DCP Anchors	m <sup>3</sup>	\$2,500	1,420	\$3,550,000
4.05	Spillway Approach / Training Walls - Incl. DCP Anchors	m <sup>3</sup>	\$2,500	290	\$725,000
4.06	Embankment Connections to Training Walls (Incl. Filters)	m <sup>3</sup>	\$120	3,000	\$360,000
5	Tertiary Spillway (Fuse Plug Emb.)				
5.01	New fuse embankment (~50 m <sup>2</sup> /m)	m	\$10,000	700	\$7,000,000
5.02	Concrete training walls at each end of fuse embankment	m <sup>3</sup>	\$2,500	200	\$500,000
5.03	Raising secondary embankments (~2 m <sup>2</sup> /m)	m	\$800	1,800	\$1,440,000
6	Other Items				
6.01	Site Rehabilitation	LS	\$100,000	1	\$100,000
Total Direct Cost				-	\$28,141,740
Total Indirects, Design, Margin, Contingency, Etc.				100%	\$28,141,740
<b>TOTAL OUT-TURN COST</b>				-	<b>\$56,283,480</b>

## 8.2 Costs to offset supply reliability changes

### 8.2.1 Estimated using the GSM

For the options that reduce the target storage or FSL at Lake Eppalock, there will be water resource implications (Section 5). These will be predominately felt by entitlement holders in the Campaspe system (the Goulburn and Coliban systems are relatively unaffected). This report section considers the costs that may be associated with offsetting the reduced reliability of supply for entitlement holders. The assessment is preliminary in nature, and therefore the cost estimates will change in future if more detailed investigations are done of potential ways to address the supply reliability impacts of reducing the Lake Eppalock target storage or FSL.

The volume of water that may need to be recovered to offset the reduced reliability of supply to entitlement holders was estimated using the same version of the GSM described in Section 5. However, prior to completing this assessment, the climate and inflow inputs to the GSM for the period pre-1975 were transformed to represent post-1975 conditions, using seasonally-based decile scaling in accordance with the *Guidelines for Assessing the Impact of Climate Change on Water Availability in Victoria* (DELWP, 2020). This is because the post-1975 reference period is more representative of recent water availability compared with long-term historic climate conditions (DELWP, 2020).

To estimate the water recovery volumes, the limit curves for simulated non-urban demands in the GSM downstream of Lake Eppalock were reduced until the modelled seasonal determinations (i.e. allocations) for each option was similar to the base case under post-1975 conditions. The limit curves describe the maximum volume supplied in a water year for a given allocation. Only non-urban (i.e. irrigator and environmental) demands were considered, because they represent the bulk of the water use in the Campaspe system downstream of Lake Eppalock.

Figure 53 shows the combined limit curves in the GSM for the non-urban demands downstream of Lake Eppalock, for the base case and the options that involve reducing the Lake Eppalock target storage or FSL to 50%, 70% or 90% of the current FSL. The difference the limit curves shown in Figure 53 make to simulated February allocations in the Campaspe system is demonstrated in Figure 54.

The top section of Figure 54 shows the modelled distribution of February allocations under post-1975 climate conditions prior to altering the limit curves, and the bottom section shows the February allocations after the changes. Although the allocation distributions for the base case and options assessed are not a perfect match, they are reasonably similar with one exception. For the 50% of FSL target storage option, it was not possible to match the base case distribution of modelled allocations from 100% to 200% of HRWS plus LRWS. That is, the reliability of supply impacts for LRWS in the Campaspe system if the 50% target storage option was implemented may only be able to be offset by purchasing or retiring all LRWS.

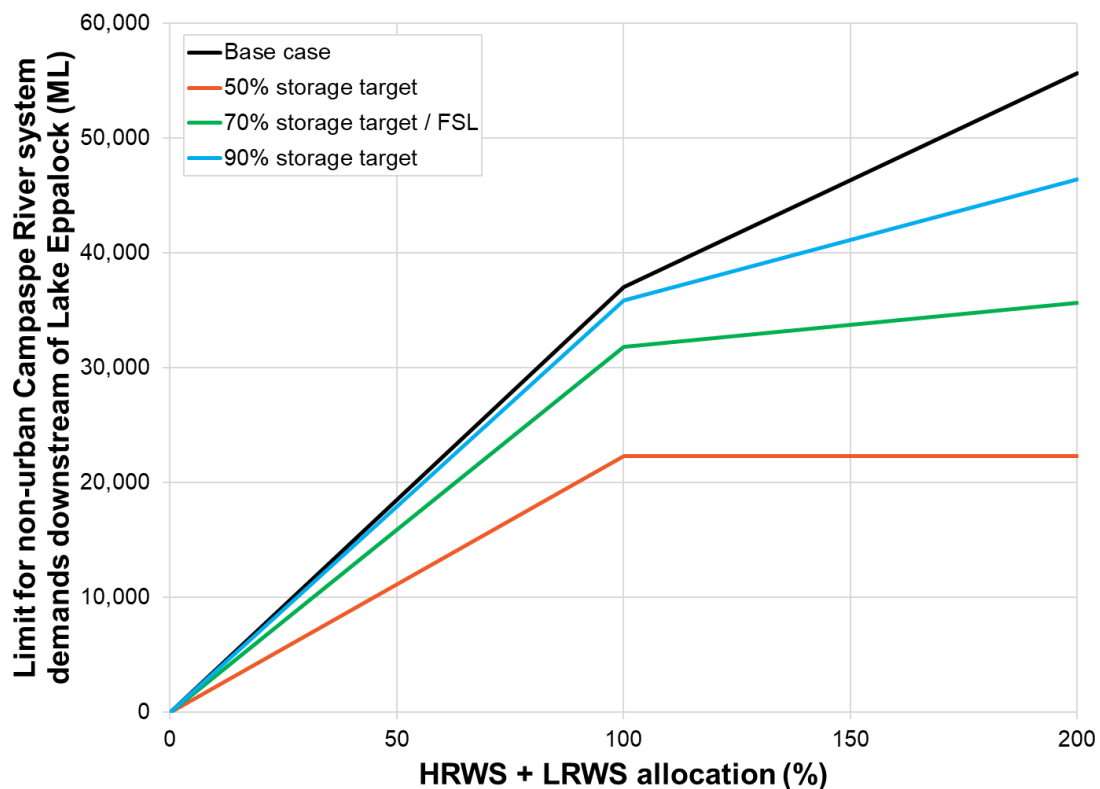

Figure 53: Simulated changes to the limit curves in the GSM that represent the maximum volume supplied to non-urban demands downstream of Lake Eppalock for a given HRWS plus LRWS allocation

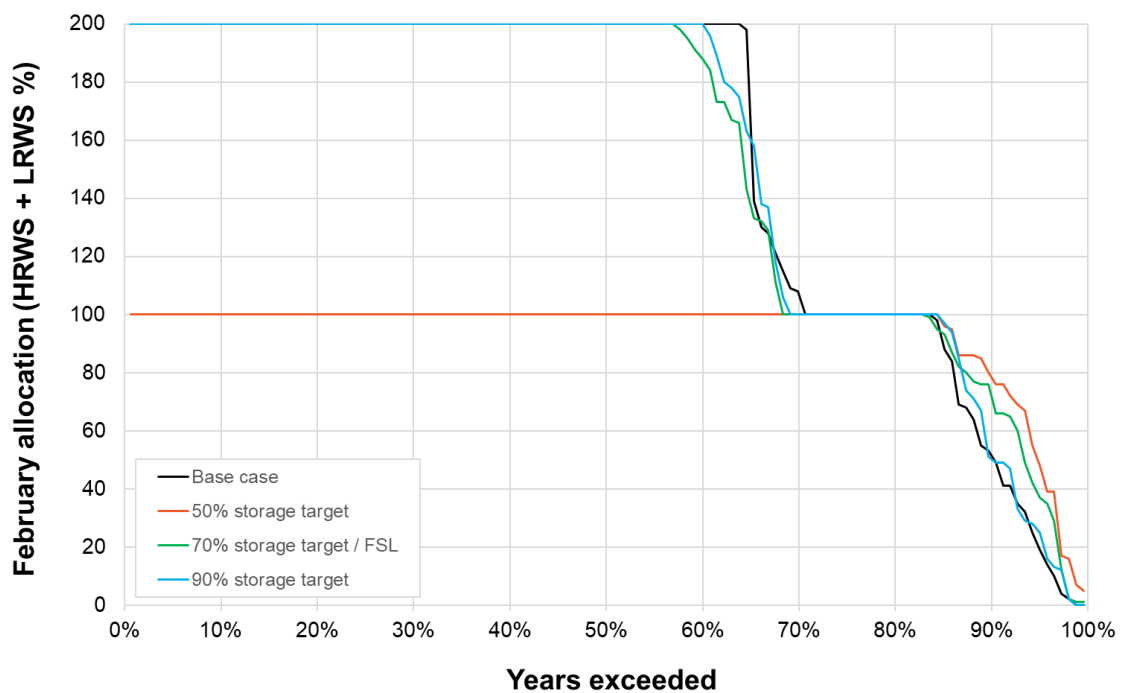
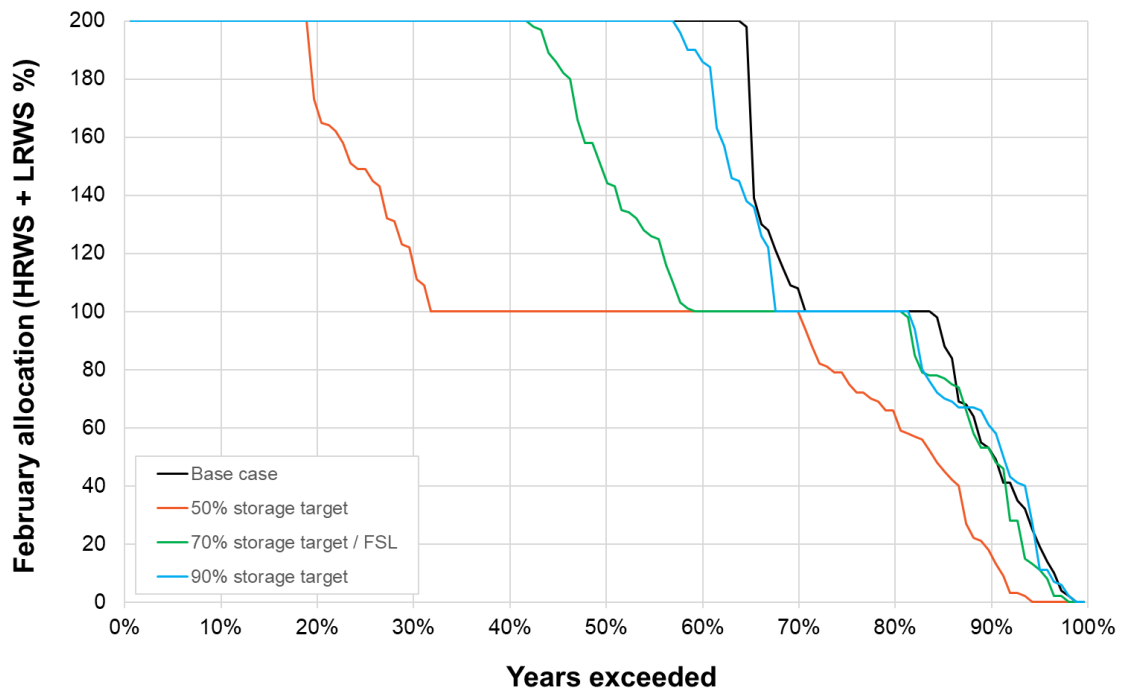

Figure 54: The simulated proportion of years when seasonal determinations (allocations) of varying percentages to HRWS and LRWS in the Campaspe system are exceeded in February under post-1975 conditions for options that reduce the Lake Eppalock target storage – before (top) and after changes to the limit curves in the GSM (bottom)



The differences between the base case and the three options at the 100% and 200% allocation points in Figure 53 can be used to estimate the volume of HRWS and LRWS that may need to be recovered to offset the reduced reliability of supply to entitlement holders in the Campaspe system if the Lake Eppalock target storage or FSL was reduced. These volumes are summarised in Table 23.

Table 23: Approximate volumes that would be required to offset changes to reliability of supply

Option	Limit curve for given allocation (ML)		Difference to base case (ML)		Approximate volume to offset impact (ML)	
	At 100%	At 200%	At 100%	At 200%	HRWS	LRWS
Base case	36,980	55,640	-	-	-	-
90% target storage	35,840	46,400	1,140	9,240	1,140	8,100
70% target storage / FSL	31,840	35,650	5,140	19,990	5,140	14,850
50% target storage	22,300	22,300	14,680	33,340	14,680	*18,660

\* Estimates of the LRWS that would need to be recovered depends on whether the volume is estimated using differences between the limit curves for the base case and 50% target storage option in Figure 53, or is estimated as 100% of LRWS volumes on the Victorian water register. The former option has been used for this assessment.

Within the Campaspe system there is approximately 60,000 ML of water shares and environmental entitlements that can be supplied from GMW's 82% share of Lake Eppalock (<https://waterregister.vic.gov.au/>). Therefore, if 9,240 ML, 19,990 ML or 33,340 ML of HRWS plus LRWS needs to be recovered to offset the supply reliability impacts of reducing the Lake Eppalock target storage or FSL to 90%, 70% or 50% of the current FSL, this is equivalent to approximately 15%, 33% or 55% of the existing entitlements and water shares. At present, irrigators and water corporations hold approximately 60% of the combined high- and low-reliability entitlements and water shares in the Campaspe system, and the environment – via the Victorian and Commonwealth environmental water holders – has the other 40%.

The cost associated with purchasing the water shares shown in Table 23 were estimated by multiplying the HRWS volumes by \$4,000 / ML and the LRWS volumes by \$1,000 / ML. These are the prices that HRWS and LRWS have most recently traded at in the Campaspe system, according to the Victorian Water Register (<https://waterregister.vic.gov.au/>). The results are included in Section 8.3, but it needs to be recognised that:

- This assessment does not account for the ongoing socio-economic consequences of reducing the volume of water stored in the Campaspe system, and the recreational impacts of holding Lake Eppalock below FSL.
- The costs will also depend on government policy decisions – which are yet to be made – about what mechanisms would be appropriate for recovering the water (e.g. purchases via the water market, changes to bulk entitlements), and whether the approach is the same for all entitlement holders or varies by end-use (e.g. consumptive vs environmental; urban vs non-urban).

The exercise above was also repeated using modelled allocations for the month of October. And although Section 5.2 shows that the differences in early season allocations are greater than for late season allocations if the target storage or FSL at Lake Eppalock is reduced, the volumes required to offset the early season differences were estimated to be similar to or less

than the volumes summarised in Table 23. Therefore, it is unlikely that the volumes in Table 23 would increase significantly if GSM allocations for months other than February are used to estimate how much HRWS and LRWS would need to be recovered to offset the reliability of supply impacts for entitlement holders.

### 8.2.2 Sensitivity testing using the SGEFM

Similar to the sensitivity testing done in Section 6.5, the volume of HRWS and LRWS that would need to be recovered from the Campaspe system to offset the reduced reliability of supply to entitlement holders was re-estimated using the SGEFM. The SGEFM, developed by the University of Melbourne (John, 2021), was used primarily to assess expected changes to the daily flow regime downstream of Lake Eppalock (Section 10), but it can also produce time-series of modelled allocations and this provided an opportunity to sensitivity test the results included in Section 8.2.1.

Given this was a sensitivity test, the climate and streamflow inputs to the SGEFM for the period pre-1975 were transformed to represent post-1975 conditions using a simple factoring approach rather than decile scaling, and the assessment was based on returning the average annual end-of-season allocation to base case conditions, rather than matching the distribution of February allocations as per Section 8.2.1.

Table 24 shows the results, and how they compare the volumes estimated using the GSM. Although there are some differences – which is to be expected given the differences in period of record, pre-1975 factoring approach and the metric used to estimate the volumes needed to be recovered – the order of magnitude is similar when converted to an associated cost.

The similarity between estimates made using the GSM and SGEFM is reassuring (Table 24) but does not mean the values reported are accurate and precise. Estimates of the water recovery required to offset changes to entitlement holders' supply reliability if the Lake Eppalock target storage or FSL is reduced may be noticeably different if other climate conditions are modelled, the assessment is done in more detail (e.g. by changing both the limit curves and demand nodes in the GSM), different combinations of recovering high and low-reliability entitlements are tested, or the assessment is repeated using the DEECA daily Goulburn-Broken-Campaspe-Coliban-Loddon Source model (which is intended to replace the GSM in the near future).

Table 24: Approximate volumes that would be required to offset changes to reliability of supply – sensitivity testing

Option	GSM estimates			SGEFM estimates		
	HRWS (ML)	LRWS (ML)	Cost (\$m)	HRWS (ML)	LRWS (ML)	Cost (\$m)
Base case	-	-		-	-	
90% target storage	1,140	8,100	\$12.7	1,000	6,000	\$10.0
70% target storage / FSL	5,140	14,850	\$35.4	9,000	7,200	\$43.2
50% target storage	14,680	18,160	\$77.4	11,000	*22,150	\$66.2

\* The SGEFM includes slightly different volumes of water shares in the Campaspe system compared with the GSM



### 8.3 Initial capital cost summary

Table 25 combines the estimated costs in Section 8.1 and Section 8.2 into a total initial capital cost for each of the options assessed to increase the flood mitigation provided by Lake Eppalock. Figure 55 plots these costs versus the estimated reduction of peak outflows from Lake Eppalock – for events with AEP of 5% (~minor flood), 1% (~moderate flood) and 0.2% (~major flood) – from Table 15 in Section 6, and for the 2011 and 2022 floods (Figure 45 and Figure 46 in Section 7).

Observations that can be made from Figure 55 include that:

- There is a reasonable correlation between the degree to which peak outflows from Lake Eppalock are reduced, and the cost of implementing an option.
- The slot spillway, spillway gates and piano keys spillways options tend to make a bigger difference to the rarer floods (0.2% AEP) compared with the more common floods (5% AEP), whereas this pattern is reversed for the options that reduce target storage to 70% or 90% of the current FSL.

Table 25: Best estimates of indicative initial capital costs for the operating and infrastructure options considered in this study for increasing flood mitigation at Lake Eppalock, in order of lowest to highest

Option	Approximate initial capital costs (in millions)		
	Construction (rounded)	Water shares (rounded)	Approx. total
90% target storage	-	\$15	\$15
70% target storage	-	\$35	\$35
Slot spillway at 70% FSL	\$5	\$35	\$40
90% target storage + 5,000 ML/d outlet	\$30	\$15	\$45
Piano key spillways	\$60	-	\$60
70% target storage + 5,000 ML/d outlet	\$30	\$35	\$65
50% target storage	-	\$75	\$75
50% target storage + 5,000 ML/d outlet	\$30	\$75	\$105
Spillway gates	\$200	-	\$200

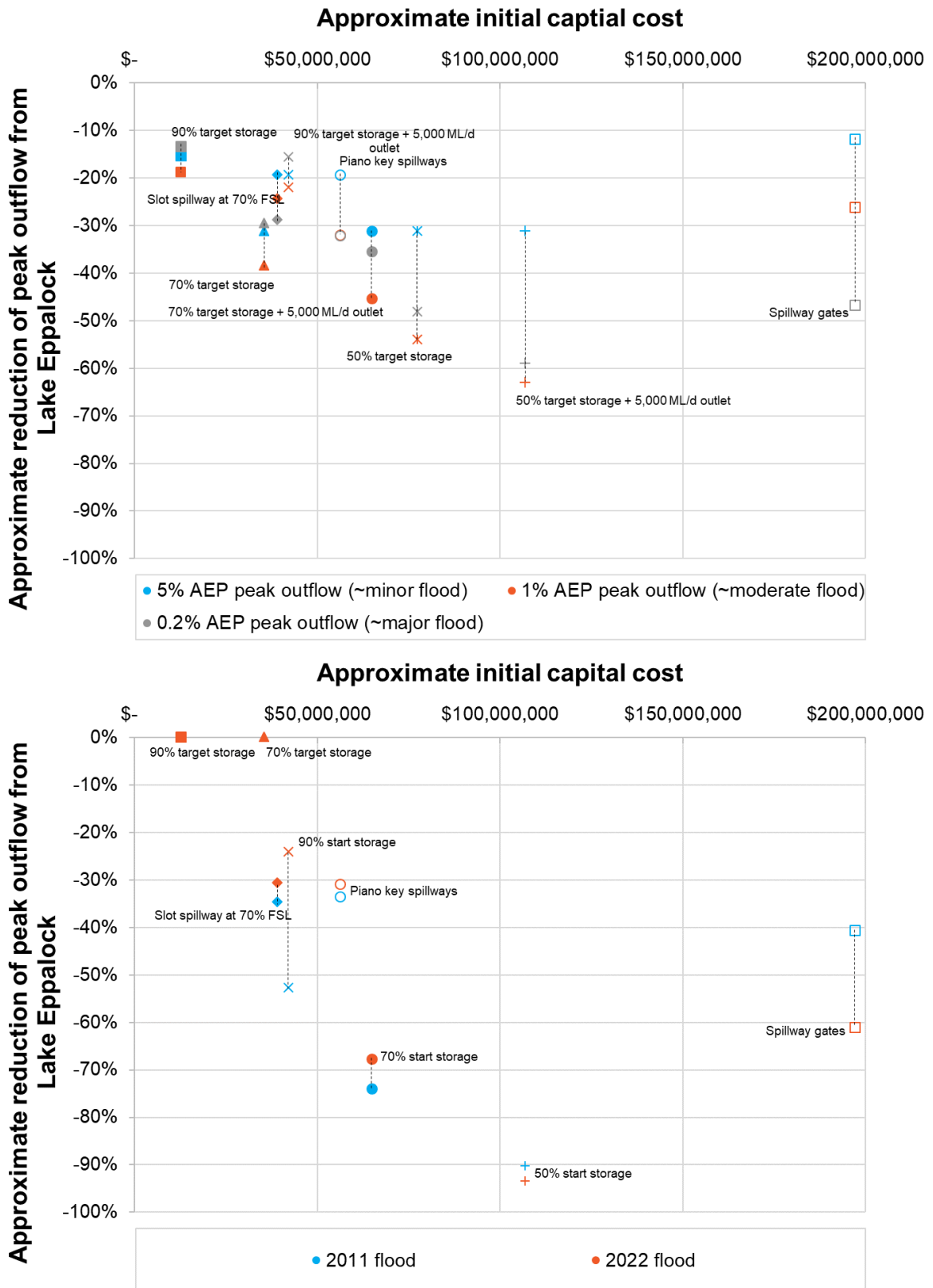

Figure 55: Approximate initial capital costs versus approximate degree of reduction in peak outflows from Lake Eppalock that have an estimated AEP of 5%, 1% and 0.2% (top) and those experienced in 2011 and 2022 (bottom). A 90%, 70% or 50% start storage would only have been achievable with an increased outlet capacity.





The costs in Table 25 do not include:

- Foregone production if the volume of water available for consumptive use in the Campaspe system is reduced
- The costs of compensating upstream landholders or relocating recreational and commercial tourism sites above the increased peak reservoir levels expected at Lake Eppalock during floods, if the spillway gates or piano keys spillways options are implemented
- The costs of modifying community assets around Lake Eppalock (e.g. boat ramps) so they have the same utility if the target storage or FSL is reduced
- Reduced income to GMW from fees associated with storing water if entitlements are retired from the Campaspe system. The annual entitlement storage fees are currently \$10.59/ML for HRWS and \$4.84 for LRWS<sup>33</sup>, and therefore the fees foregone may be in the range of approximately \$40,000 to \$250,000 each year, based on the options and volumes included in Table 24.
- The additional operation and maintenance costs associated with a second outlet or spillway gates at Lake Eppalock (Table 26).

The spillway gate option in particular would require ongoing spending on gate maintenance and forecasting / modelling capabilities for deployment during flood events.

**Table 26: Increased ongoing costs anticipated for the Lake Eppalock storage operator**

Option	Changes to operation and maintenance costs and annual entitlement storage fees
90% target storage	<ul style="list-style-type: none"> <li>▪ Decreased annual entitlement storage fees</li> </ul>
70% target storage	
50% target storage	
90% target storage + 5,000 ML/d outlet	<ul style="list-style-type: none"> <li>▪ Decreased annual entitlement storage fees</li> <li>▪ Increased cost from maintaining a second outlet</li> </ul>
70% target storage + 5,000 ML/d outlet	
50% target storage + 5,000 ML/d outlet	
Slot spillway at 70% FSL	<ul style="list-style-type: none"> <li>▪ Decreased annual entitlement storage fees</li> </ul>
Spillway gates	<ul style="list-style-type: none"> <li>▪ Increased cost from maintaining spillway gates</li> <li>▪ Increased staffing cost (approximately 2 FTE) to operate a gated storage</li> </ul>
Piano key spillways	<ul style="list-style-type: none"> <li>▪ No significant changes anticipated</li> </ul>

The values included in Table 25 are also only indicative best estimates. Table 27 shows how far the actual initial capital cost may range, assuming that:

- The AACE Class 5 estimates for the works are within -50% to +100% of the true cost of design and construction
- The costs associated with offsetting the supply reliability impacts are within the range approximately \$5 million either side of the different cost estimates in Table 24.

<sup>33</sup> [www.g-mwater.com.au/downloads/gmw/Pricing\\_List/20230530\\_GMW\\_Pricing\\_Table\\_2023\\_24.pdf](http://www.g-mwater.com.au/downloads/gmw/Pricing_List/20230530_GMW_Pricing_Table_2023_24.pdf)



Table 27: Potential ranges of the initial capital costs for the operating and infrastructure options considered in this study for increasing flood mitigation at Lake Eppalock

Option	Approximate initial capital costs (in millions)		
	Construction	Water shares	Approx. total
90% target storage	-	\$5 - \$20	\$5 - \$20
70% target storage	-	\$30 - \$50	\$30 - \$50
Slot spillway at 70% FSL	\$2.5 - \$10	\$30 - \$50	\$32.5 - \$60
90% target storage + 5,000 ML/d outlet	\$15 - \$60	\$5 - \$20	\$20 - \$80
Piano key spillways	\$30 - 120	-	\$30 - \$120
70% target storage + 5,000 ML/d outlet	\$15 - \$60	\$30 - \$50	\$45 - \$110
50% target storage	-	\$60 - \$80	\$60 - \$80
50% target storage + 5,000 ML/d outlet	\$15 - \$60	\$60 - \$80	\$75 - \$140
Spillway gates	\$100 - \$400	-	\$100 - \$400



## 9. Upstream impacts

### 9.1 Reduced target storage or full supply level

The options that include a reduced target storage or FSL at Lake Eppalock will reduce the extent of the waterbody. Map M1 below shows the difference in footprint between the current FSL at Lake Eppalock, and the footprint at 50%, 70% and 90% of FSL, both for the reservoir as a whole and focused on seven different locations around the lake.

Map M1 demonstrates that if the target storage or FSL is reduced at Lake Eppalock:

- The waterbody will cover a smaller area, with the differences most noticeable in the shallow regions of Lake Eppalock (for example the south-east corner)
- A number of islands in the reservoir will become permanently connected to the shore if the 50% of FSL target storage option is implemented
- The distance between community and recreational facilities (e.g. holiday accommodation) and the water's edge will increase noticeably under the 50% and 70% of FSL options.

The consequences of these changes are likely to include:

- Having to extend existing boat ramps so they are useable with the reduced target storage or FSL at Lake Eppalock
- Reducing the areas where watercraft can be used, or used without speed limits

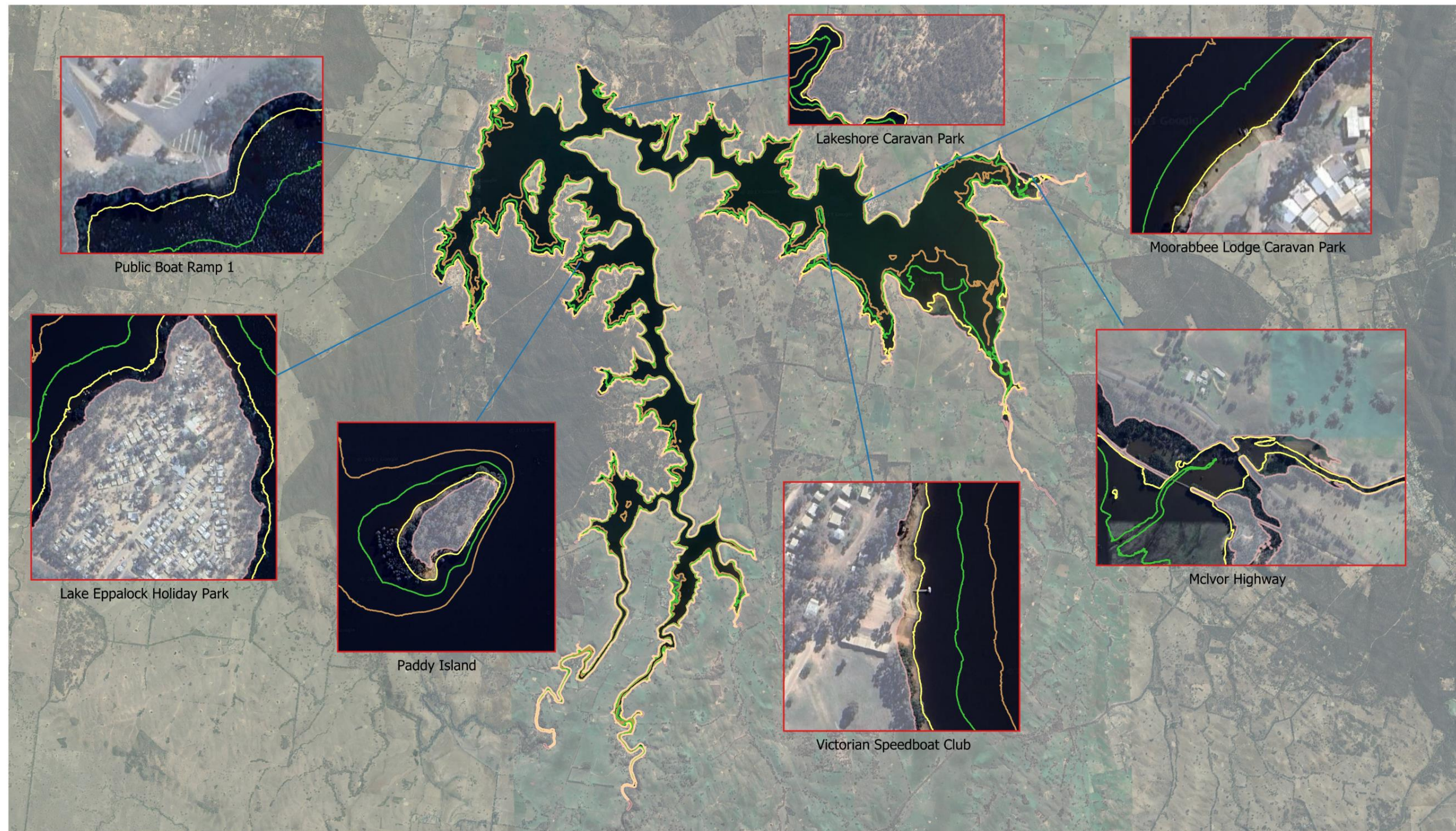

Legend  
 50% of Current FSL    90% of Current FSL  
 70% of Current FSL    Current FSL (full supply level)

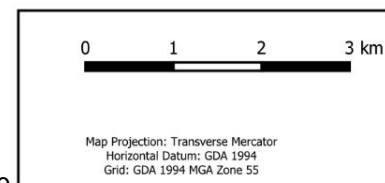

Study Name - Lake Eppalock flood mitigation options assessment

Job Number	VIC00115
Revision	A
Date	31 Aug 2023
Reviewed By	S. Lang
Created By	S. Attarzadeh
Map Number	VIC00115-M1



## 9.2 Increased reservoir level during floods

The options that involve adding spillway gates or piano keys to the primary and secondary spillway will raise the reservoir level and hence extent of inundation around Lake Eppalock during floods. The estimated<sup>34</sup> changes in reservoir level if the 2011 and 2022 floods were repeated with these options in place are shown in Figure 45 and Figure 46 respectively.

Maps M2 and M3 below convert the peak reservoir levels in Figure 45 and Figure 46 for the spillway gates and piano keys spillways options into inundation extents upstream of Lake Eppalock, and compares them with the footprints experienced with the current dam and spillway configuration in place. The number of additional buildings around Lake Eppalock that would have been inundated in 2011 and 2022 under the spillway gates or piano keys spillway options is summarised in Table 28. Map M4 shows the location of the extra ~160 buildings that would have been subject to flooding in 2022 if the piano keys spillways were constructed, and demonstrates that most of these buildings are within the holiday and caravan parks around the lake's edge.

The estimated damage costs associated with increasing the reservoir level during floods at Lake Eppalock are included in Section 11.2.2.

**Table 28: Estimates of the number of buildings inundated around Lake Eppalock during the 2011 and 2022 floods, and if the floods were repeated with the spillway gates or piano keys spillways options implemented**

Year / option	Estimated number of buildings inundated	Difference to base case
2011 – base case	60	-
2011 – add spillway gates	120	60
2011 – piano key spillways	170	110
2022 – base case	110	-
2022 – add spillway gates	225	115
2022 – add piano key spillways	270	160

<sup>34</sup> The values in Table 28, the waterbody extents shown in Maps M2 and M3, and the building locations identified in Map M4 are based on modelled water levels, rather than ground-truthed water levels

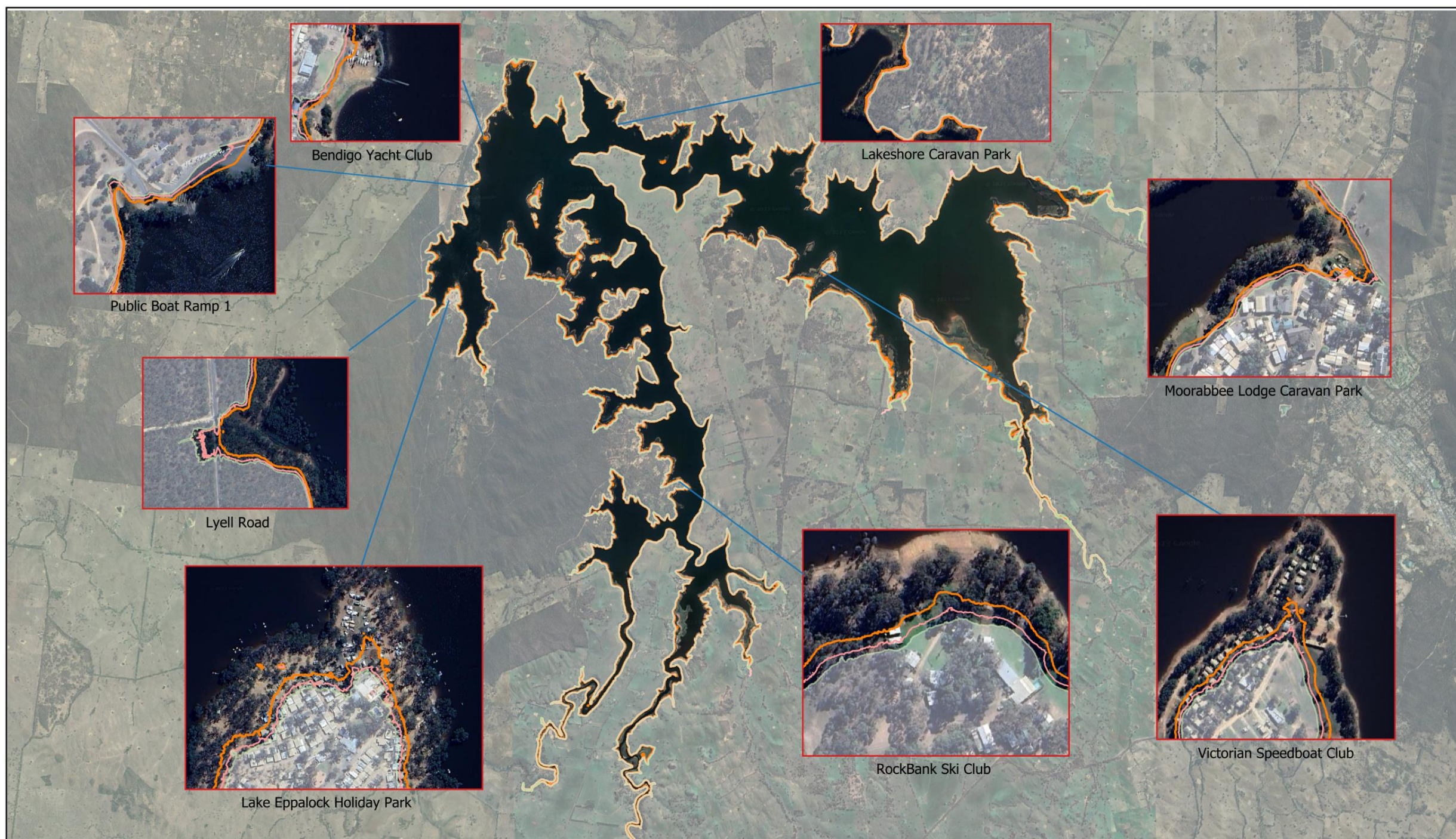

Legend  
 □ January 2011 flood with spillway gates   □ January 2011 flood with piano key spillways  
 □ January 2011 flood extent

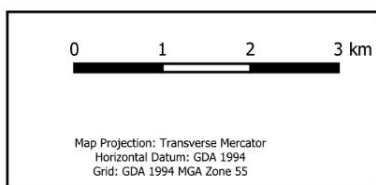

Study Name - Lake Eppalock flood mitigation options assessment

Job Number	VIC00115
Revision	A
Date	29 Sep 2023
Reviewed By	S. Lang
Created By	S. Attarzadeh
Map Number	VIC00115-M2

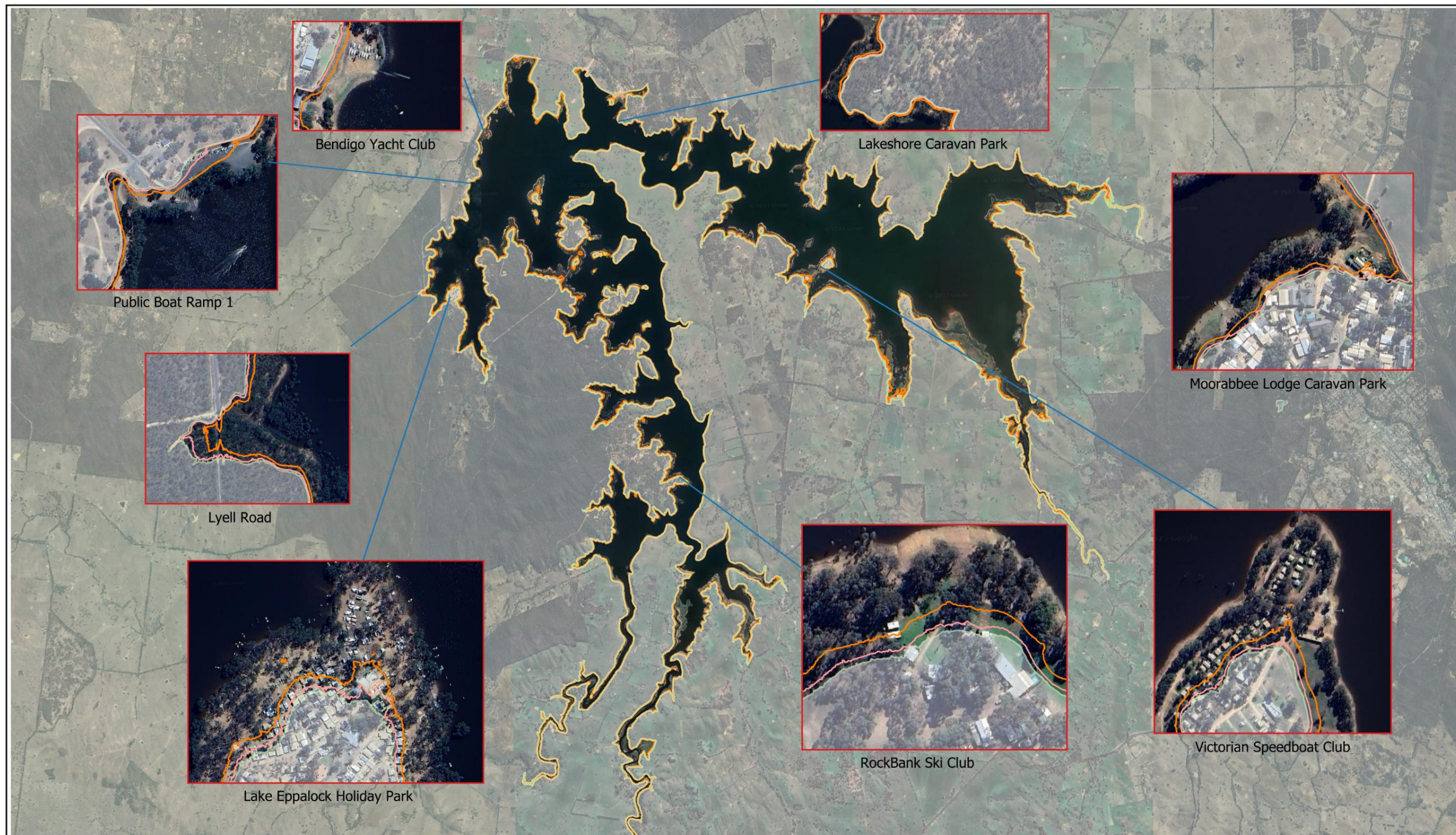

Legend  
 ■ October 2022 flood with spillway gates   ■ October 2022 flood with piano key spillways  
 ■ October 2022 flood extent

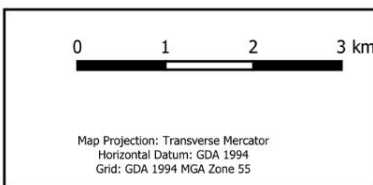

Study Name - Lake Eppalock flood mitigation options assessment

Job Number	VIC00115
Revision	A
Date	05 Sep 2023
Reviewed By	S. Lang
Created By	S. Attarzadeh
Map Number	VIC00115-M3

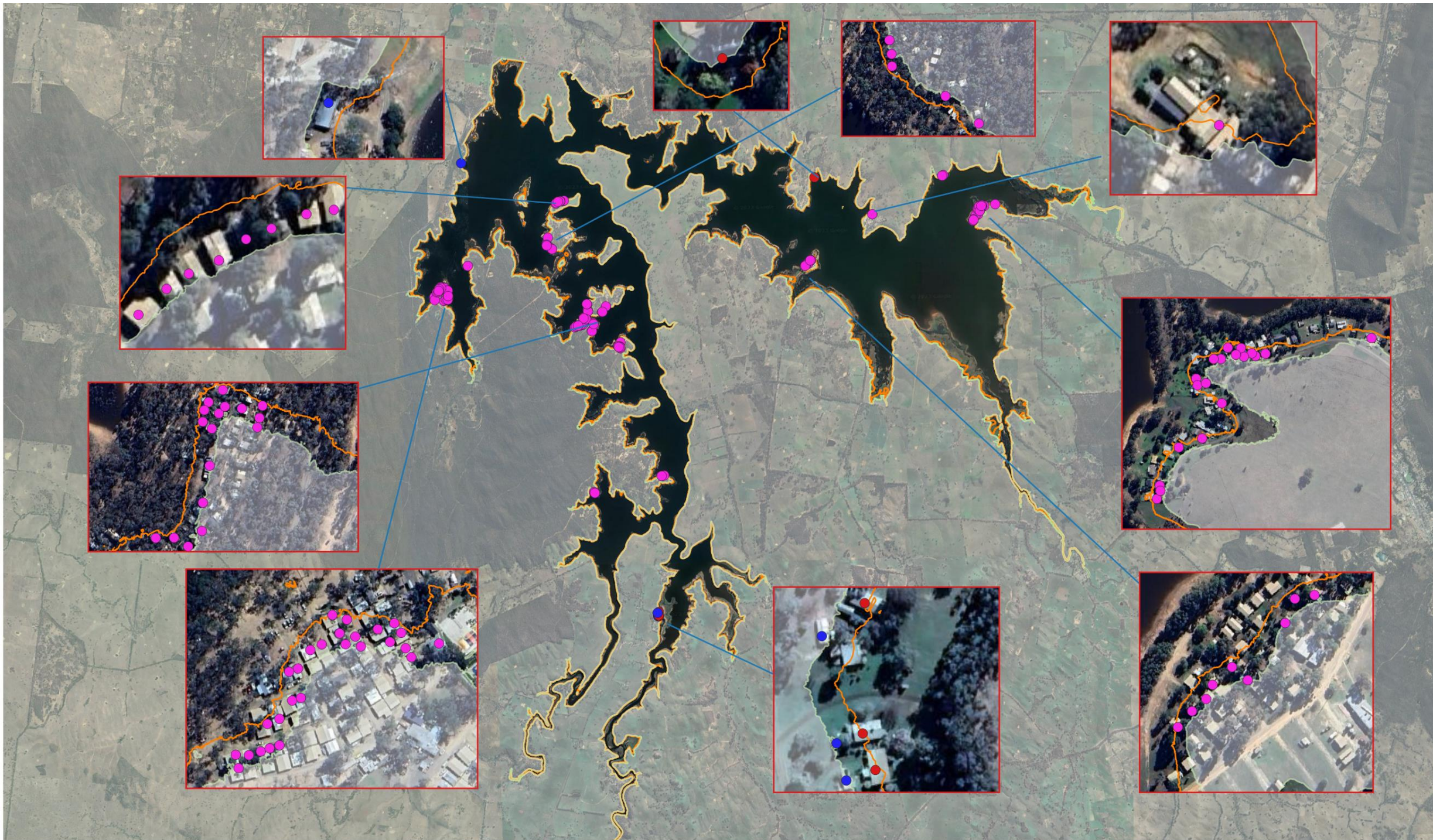

Legend  
 ● Holiday/Caravan Park    □ October 2022 flood extent with piano key spillways  
 ● Residential                □ October 2022 flood extent  
 ● Shed

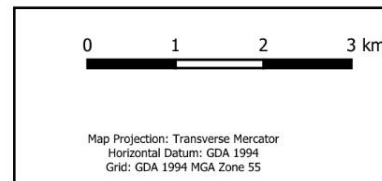

Additional buildings inundated in the 2022 flood event with the piano key spillway option compared to current infrastructure and operating conditions

Job Number	VIC00115
Revision	A
Date	03 Oct 2023
Reviewed By	S. Lang
Created By	S. Attarzadeh
Map Number	VIC00115-M4





## 10. Changes to downstream flow regime

The options to reduce the target storage or FSL at Lake Eppalock will change the peak outflow frequencies (Section 6), and the general patterns of flow in the Campaspe River downstream of the dam. This report section describes how the changes to the downstream flow regime were modelled, and summarises the outcomes.

### 10.1 Monthly time-step assessment

The same water resource plan version of the GSM described in Section 5 was used to simulate the monthly flow in the Campaspe River at Echuca under long-term historic and post-1975 climate conditions. Only the results for the long-term historic climate conditions assessment are presented here; how the options compare with the base case is similar in the post-1975 case.

Figure 56 shows a flow duration curve for modelled monthly flows in the Campaspe River at Echuca under the base case and the options to reduce the target storage at Lake Eppalock to 50%, 70% or 90% of the current FSL, using either the existing outlet capacity (top) or with the outlet capacity increased to 5,000 ML/d (bottom). A flow duration curves describes the proportion of time a flow of a given magnitude is expected to be met or exceeded.

From Figure 56, the following observations can be made:

- The minimum passing flows specified in the Bulk Entitlement (Campaspe System – Goulburn-Murray Water; <https://waterregister.vic.gov.au/water-entitlements/bulk-entitlements>) for downstream of Lake Eppalock and the Campaspe siphon depend on the volume stored in Lake Eppalock. For example, if the volume is  $\leq 200,000$  ML the minimum passing flow downstream of the Campaspe siphon is 35 ML/d (or natural), but if the volume is  $\geq 200,000$  ML the passing flow is 70 ML/d (or natural). Under the options that involve reducing the target storage to 50% or 70% of the current FSL (304,650 ML), the proportion of time when Lake Eppalock holds  $\geq 200,000$  ML will be significantly reduced. Therefore, the proportion of time when a flow of 70 ML/d (approximately 2,100 ML/month) is provided in the Campaspe River at Echuca will also reduce under these options.
- If the target storage at Lake Eppalock is reduced to 50%, 70% or 90% of the current FSL using the existing outlet capacity, flows in the Campaspe River downstream will more often be in the range of  $\sim 10,000$  ML/month –  $\sim 50,000$  ML/month compared with the base case. This is because the existing outlet capacity is approximately 1,600 ML/d or 48,000 ML/month, and the outlet will need to be used more often to capacity to hold the reservoir level below FSL.
- If the target storage at Lake Eppalock is reduced to 50%, 70% or 90% of the current FSL using the existing outlet capacity, flows in the Campaspe River downstream will be  $\geq \sim 60,000$  ML/month less often. This is because Lake Eppalock will spill less often if the target storage is below FSL.
- If the outlet capacity is increased to 5,000 ML/d (approximately 150,000 ML/month) the degree of difference between flow durations curves for the base case and options assessed is less noticeable. This is because the proportion of time the outlet needs to operate at capacity to maintain the target storage is less compared with the existing outlet.

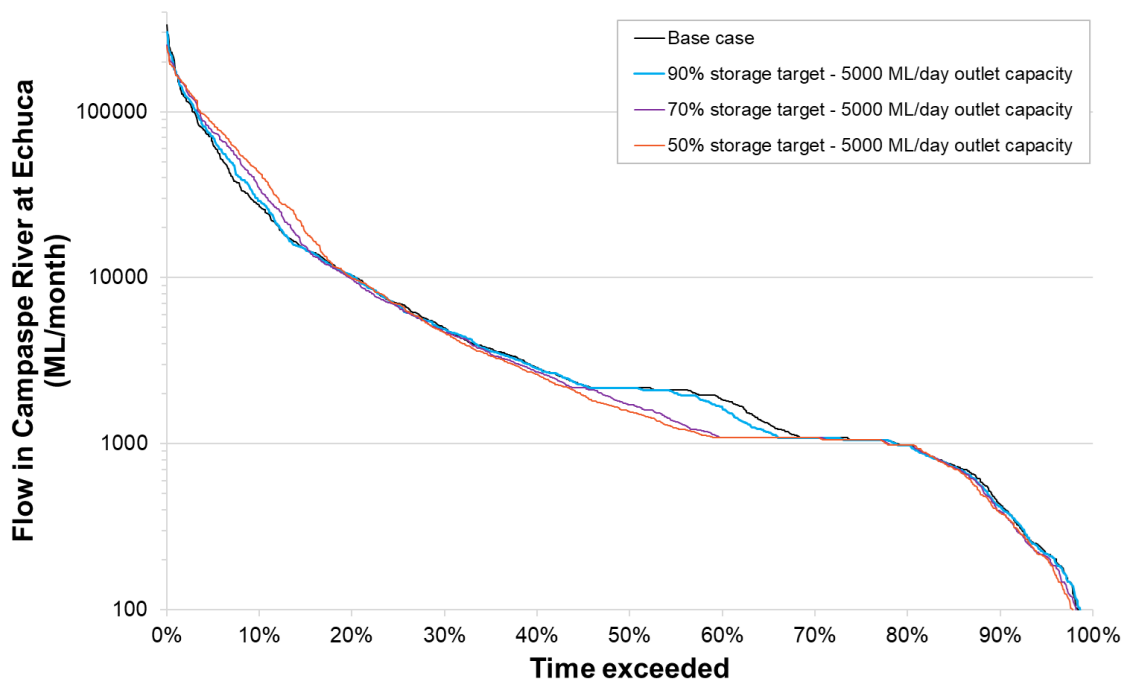
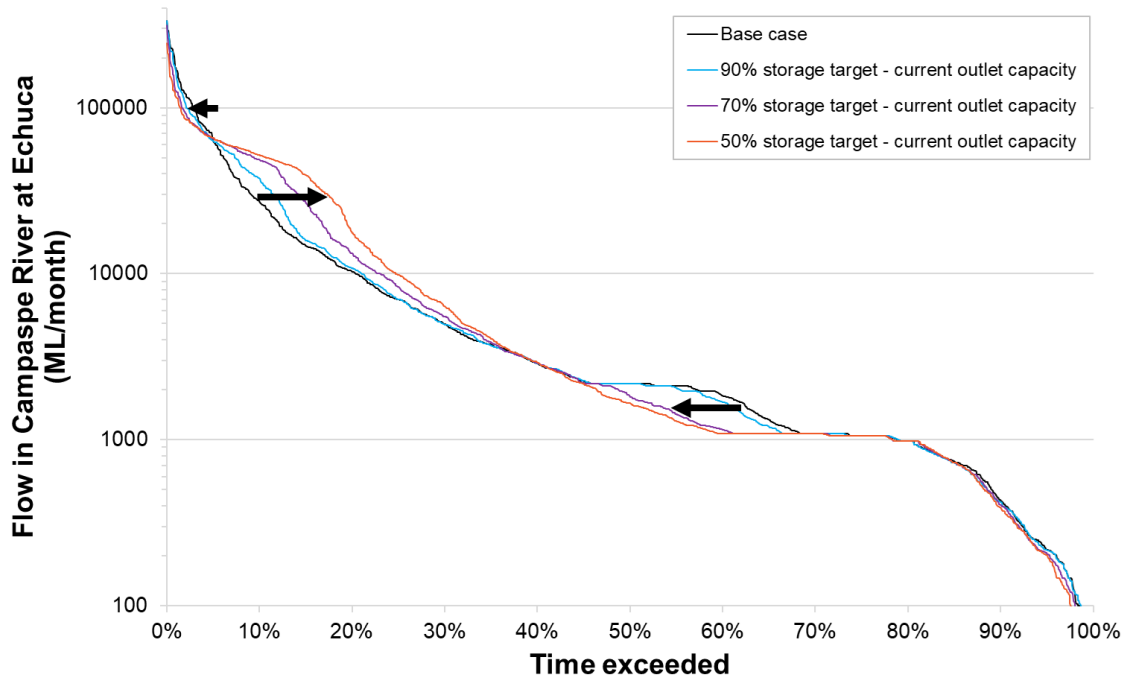

Figure 56: Simulated monthly flows in the Campaspe River at Echuca – under long-term historic climate conditions – for the base case and options to reduce the target storage at Lake Eppalock to 90%, 70% or 50% of the current FSL, using either the existing outlet capacity (top) or an increased outlet capacity (bottom). The arrows show the main differences in modelled flow between the base case and the other options, with the degree of difference somewhat less for flows >10,000 ML/month if the outlet capacity is increased to 5,000 ML/d.

Figure 57 shows the modelled flow duration curve for the Campaspe River at Echuca for the spillway slot option, as compared with the base case at the 70% target storage options. The results for the spillway slot option are very similar to the 70% target storage option with the outlet capacity increased to 5,000 ML/d. This is because both options provide greater capacity to pass water downstream of Lake Eppalock, i.e. via either the spillway slot or the increased outlet capacity.

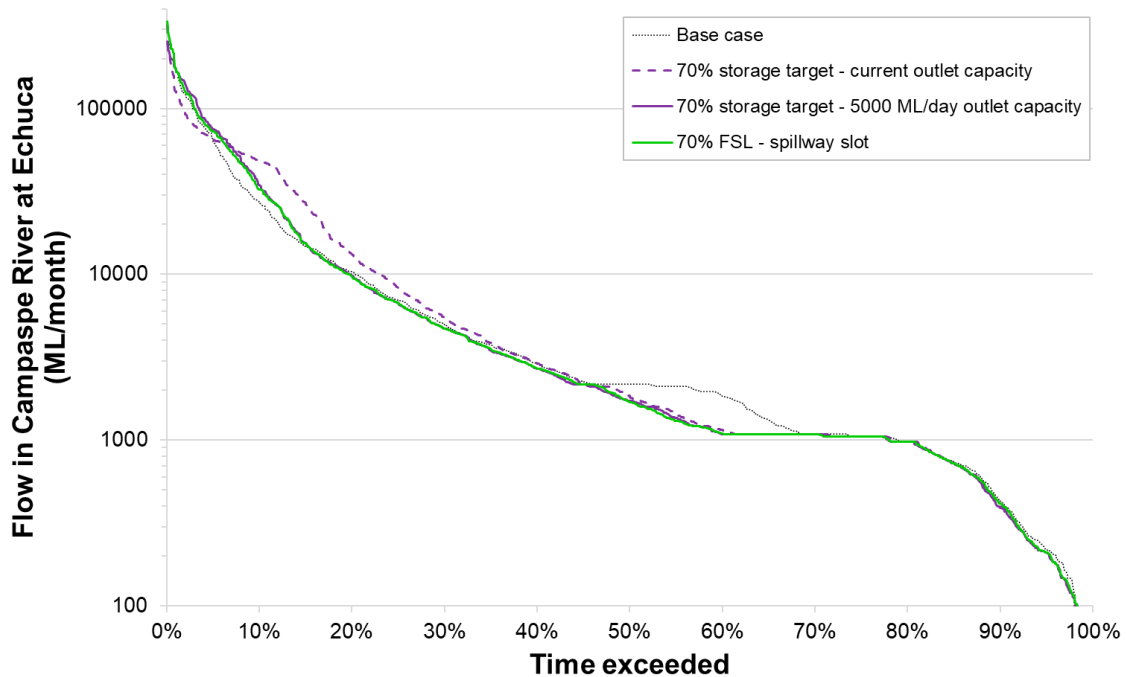

Figure 57: Simulated monthly flows in the Campaspe River at Echuca – under long-term historic climate conditions – for the base case and the option to reduce the FSL at Lake Eppalock to 70% using a spillway slot.

## 10.2 Daily time-step assessment

The use of monthly data to assess potential changes to flow regimes can mask important differences at a daily time-step. Therefore, the Stochastic Goulburn Environmental Flow Model (SGEFM) developed by the University of Melbourne (John, 2021) was also used to investigate expected changes to the flow regime downstream of Lake Eppalock.

The SGEFM was originally developed to support the Australian Research Council Linkage Project *Vulnerabilities for Environmental Water Outcomes in a Changing Climate*. The model covers the Goulburn, Broken, Campaspe and Loddon systems, and was developed in consultation with DEECA, GMW, and the Goulburn Broken Catchment Management Authority.

The SGEFM represents the current water allocation frameworks and system operations in northern Victoria’s river systems, including the management of environmental water and inter-valley transfers to the River Murray. It uses a monthly timestep to calculate water allocations and environmental and irrigation demands, and a custom disaggregation algorithm to model daily river flows (John et al., 2021b).



The SGEFM was previously used to support the update of environmental flow recommendations in the lower Goulburn (Kaiela) River (Horne et al., 2020), to understand interacting stressors to freshwater ecosystem outcomes (John et al., 2022), and to assess the effectiveness of different climate adaptation (John et al., 2021a) and constraint relaxation options (HARC, 2023) in the Goulburn River.

Each of the options described in Section 4 that involved a reduction in target storage or FSL at Lake Eppalock were simulated in the SGEFM for the period 1941 – 2021 assuming either long-term historic or post-1975 climate conditions. Figure 58 summarises the results for the base case and the options to reduce the target storage at Lake Eppalock to 90%, 70% or 50% of the current FSL, using either the existing outlet capacity (top row) or an increased outlet capacity (bottom row). This is done by plotting for each month of the year (starting in winter) the 10<sup>th</sup>, 25<sup>th</sup>, 50<sup>th</sup> (median), 75<sup>th</sup> and 90<sup>th</sup> percentile of daily flows downstream of the Western Waranga Channel, as simulated over 1941 – 2021 for the base case and the various options.

Figure 58 demonstrates that:

- If the target storage at Lake Eppalock is reduced using the existing outlet capacity, there will be a reduction of flows in winter / early spring and increased flows in late spring / early summer. This is because the outlet will often be operating near the 1,600 ML/d capacity during late spring / early summer to bring the reservoir level back to the target storage, and in winter / early spring there will be more airspace compared with the base case and hence less spills.
- If the target storage at Lake Eppalock is reduced using an increased outlet capacity of 5,000 ML/d, the 75<sup>th</sup> - 90<sup>th</sup> percentile flows in the Campaspe River downstream of Lake Eppalock (i.e. the flow magnitude met or exceeded 10% - 25% of the time) will increase. This is because an outlet capacity of 5,000 ML/d is greater than the 75<sup>th</sup> - 90<sup>th</sup> percentile flows simulated for the base case.
- The degree of difference between the base case and option modelled generally increases as the target storage is reduced (i.e. 50% of current FSL vs 90% of current FSL).

Figure 58 also compares the daily flow regime for the spillway slot option with the base case. For this option, the differences are similar to those observed for the 70% target storage option with increased outlet capacity.

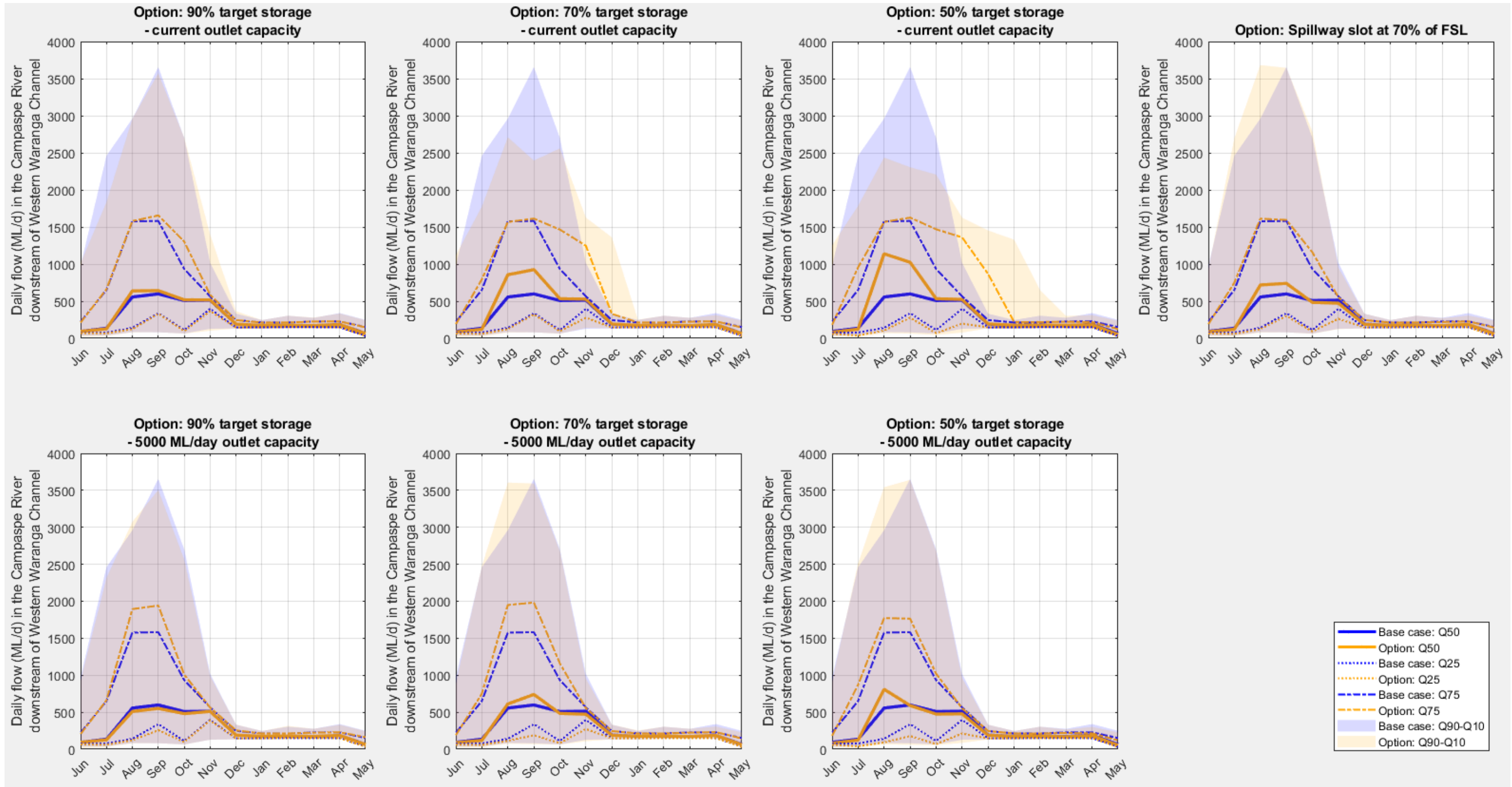

Figure 58: Simulated daily flows in the Campaspe River downstream of the Western Waranga Channel – under long-term historic climate conditions – for the base case and the options to reduce the target storage at Lake Eppalock to 90%, 70% or 50% of the current FSL, using either the existing outlet capacity, an increased outlet capacity or spillway slot



Based on these results, it can be surmised that the options to reduce the target storage at Lake Eppalock using the existing outlet capacity would have some negative environmental impacts, resulting from the shift of downstream flows from winter / early spring to late spring / early summer. In contrast, the options that include an increased outlet capacity or spillway slot are likely to have a neutral or positive impact on the downstream environment, because they provide for larger (but within bank) flows in winter / early spring.

For the increased outlet capacity option, this conclusion is based on the assumption that releasing flows from storage at up to 5,000 ML/d, which is higher than the 1,800 – 2,000 ML/d winter fresh flow recommendation downstream of Lake Eppalock but less than the 10,000 ML/d – 12,000 ML/d bankfull flow recommendation (Jacobs, 2014), will not have detrimental environmental impacts. This assumption will need to be tested in future. Further investigation will also be required to weigh the potential benefit of having higher flows down the Campaspe River if the target storage or FSL is reduced at Lake Eppalock, against the cost of having less water stored for environmental use in dry periods (e.g. the early 2000s period in Figure 18).

To further demonstrate the differences between the current outlet and increased outlet capacity options, Table 29 summarises how many days the outlet would need to be run at capacity to reduce the reservoir level from FSL (i.e. full, for example after a flood passes) to a target storage of 90%, 70% or 50% of FSL during a period of zero inflows to Lake Eppalock. This shows that the existing 1,600 ML/d outlet would need to operate at capacity for much longer periods of time compared with a 5,000 ML/d outlet to return the reservoir level to a target storage below FSL after a flood event.

Table 29: The number of days needed with an outlet of either 1,600 ML/d or 5,000 ML/d running at capacity – over a period with zero inflows to Lake Eppalock – to reduce the reservoir from FSL to 90%, 70% or 50% of FSL

Start point	End point	Volume to release	Outlet capacity	Days needed
100% full (FSL)	90% of FSL	30,465 ML	1,600 ML/d	19 days
100% full (FSL)	70% of FSL	91,395 ML	1,600 ML/d	57 days
100% full (FSL)	50% of FSL	152,325 ML	1,600 ML/d	95 days
100% full (FSL)	90% of FSL	30,465 ML	5,000 ML/d	6 days
100% full (FSL)	70% of FSL	91,395 ML	5,000 ML/d	18 days
100% full (FSL)	50% of FSL	152,325 ML	5,000 ML/d	30 days

Figure 59 is a repeat of Figure 58 but for post-1975 rather than long-term historic climate conditions. The differences between the daily flow regime for the base case and options considered are generally similar to Figure 58. The main exception is that for the post-1975 simulations, there is less difference between the 90<sup>th</sup> percentile flows for the base case, and the options that involve reducing the target storage to 70% or 50% of the current FSL while increasing the outlet capacity to 5,000 ML/d.

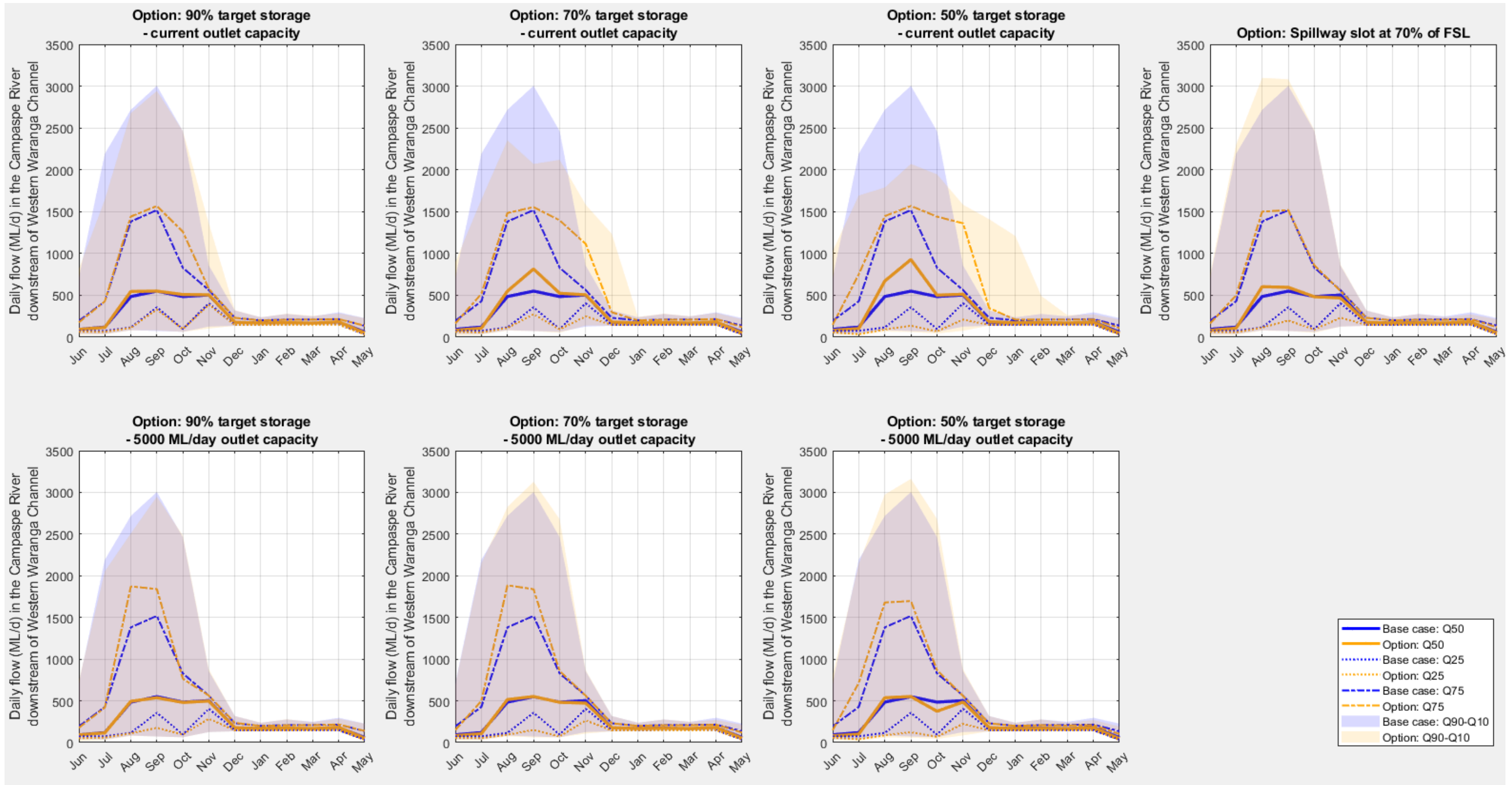

Figure 59: Simulated daily flows in the Campaspe River downstream of the Western Waranga Channel – under post-1975 climate conditions – for the base case and the options to reduce the target storage at Lake Eppalock to 90%, 70% or 50% of the current FSL, using either the existing outlet capacity, an increased outlet capacity or spillway slot



### 10.3 Traditional Owner feedback

The results of the monthly and daily time-step assessments presented above were presented to representatives of the Dja Dja Warrung clans (Djaara; <https://djadjawurrung.com.au/>) – with assistance from the North Central CMA – during an online workshop on 8 September 2023. After the workshop, the feedback from the representatives to DEECA was that:

- *[They] generally support a more naturally functioning waterway*
- *Environmental water will remain an important contributor to the waterway health, particularly to maintain resilience and mitigate the impacts of climate change*
- *Djaara is keen to increase water entitlements ownership. Any option that looks at water buybacks should consider buybacks for Djaara ownership.*
- *Equally the water usage rules should be looked at to enable Djaara owned water to deliver on the intended benefits*
- *Cultural heritage considerations need to be taken into account*
- *[Any] solution [to increase the flood mitigation provided by Lake Eppalock] is only a part of the broader suite of solutions that should be picked up in the flood management planning (Djaara should be engaged on this) that as a combined suite should all be working toward a healthy functioning system.*



## 11. Changes to downstream flooding

### 11.1 Flood class extents in Rochester

Figure 60 shows the extent of the January 2011 in Rochester, and within that extent the inundation areas corresponding with minor, moderate and major flood levels. As per the SES (2020) local flood guide:

- At minor flood level (113.0 m AHD on the Rochester town gauge), no over-floor flooding of houses is expected
- At moderate flood level (114.0 m AHD), there will be shallow inundation of areas in the north, east and centre of Rochester, but minimal over-floor flooding
- At major flood level (114.5 m AHD), the bridge is likely to be closed and over-floor flooding is expected. If flooding is 0.5 m above the major flood level, water may inundate hundreds of houses and businesses. The January 2011 flood<sup>35</sup> peaked at 115.4 m AHD on the Rochester town gauge, and the October 2022 flood reached nearly 115.7 m AHD.

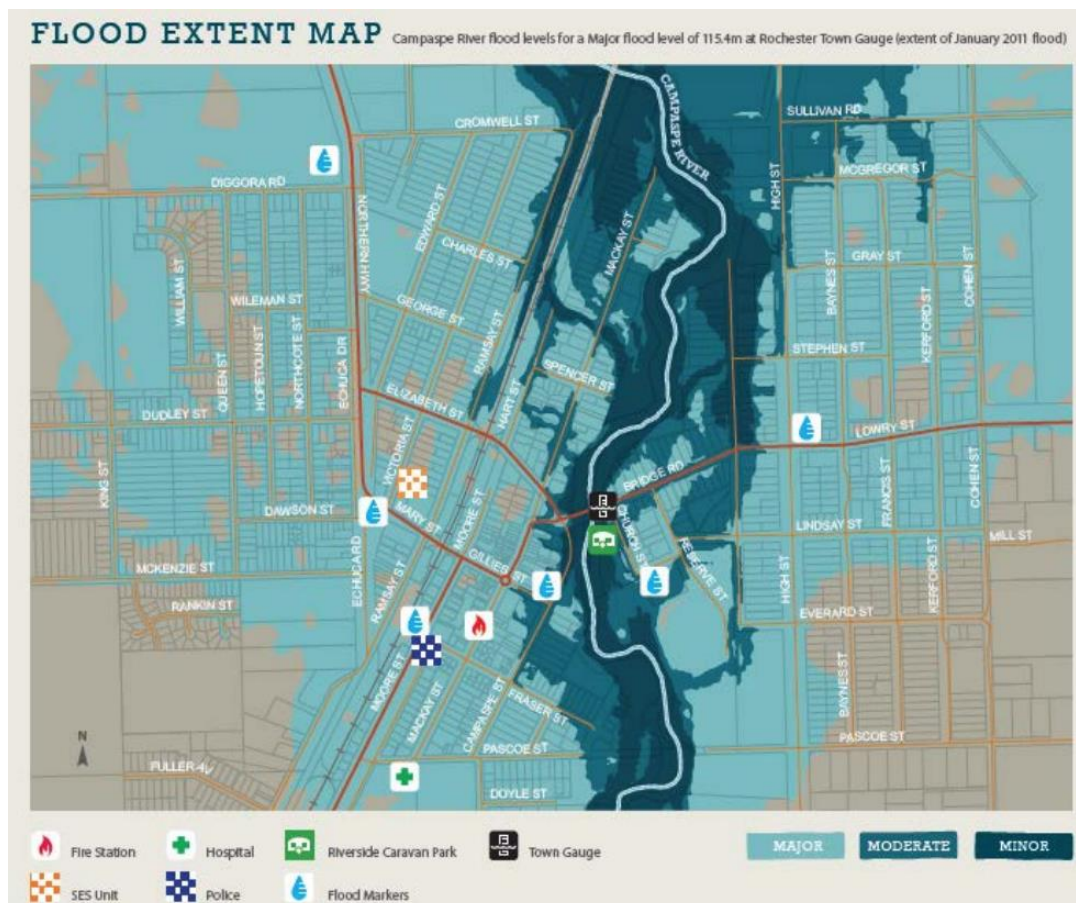

Figure 60: Flood extent map from SES (2020) local flood guide for Rochester. Note that this map references the Rochester town gauge, whereas work for this technical assessment is based on records from the Rochester syphon gauge.

<sup>35</sup> The SES (2020) local flood guide classifies the January 2011 flood as a 1% AEP event for Rochester



## 11.2 Potential changes if options were implemented

### 11.2.1 Flood peaks in Rochester

Figure 61 combines the RORB model results in Figure 45 with the observations in Figure 10. This provides an indicative assessment of how flooding in Rochester may have differed during January 2011, if the Lake Eppalock reservoir level was at 90%, 70% or 50% of FSL at the start of the event, or if the spillway slot, spillway gates or piano key spillways were in place.

Figure 61 shows that:

- For the spillway reconfiguration options, flooding in Rochester would likely still have been near or above the major flood threshold
- Flooding would have likely been in the moderate range if the Lake Eppalock start storage had been 70% or 90% of FSL.
- Of the options tested, only the 50% of FSL start storage would have reduced peak flows in Rochester to below minor flood level.

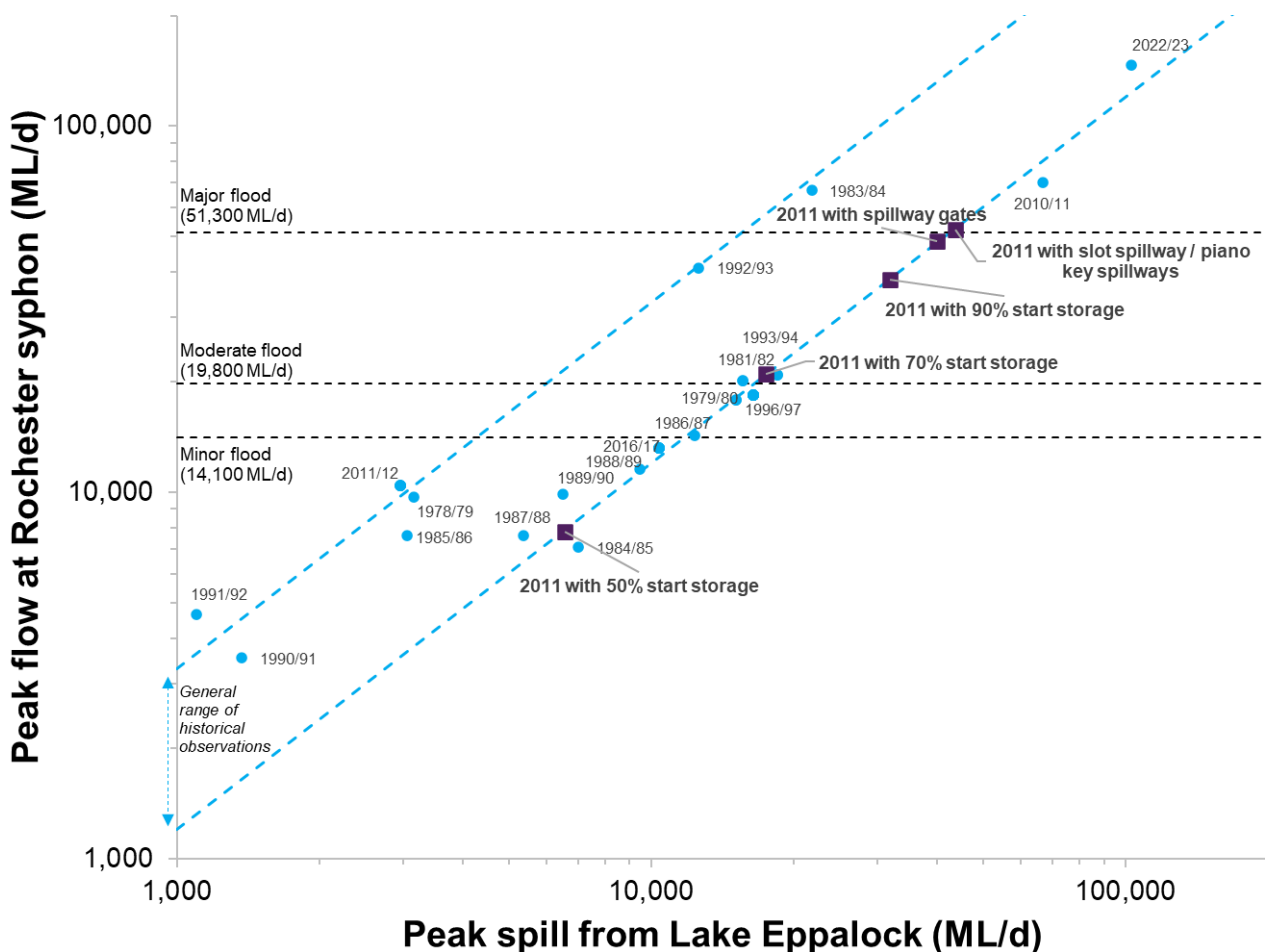

Figure 61: An indicative assessment of how the 2011 flood at Rochester may have differed if the options assessed in this study were in place. A 90%, 70% or 50% start storage would have been achievable with an increased outlet capacity.



Similar to Figure 61, Figure 62 combines the analyses in Figure 46 with the observations in Figure 10 to give an indication of how flooding in Rochester may have differed during October 2022, if the Lake Eppalock reservoir level was at 90%, 70% or 50% of FSL at the start of the event, or if the spillway slot, spillway gates or piano key spillways were in place.

Figure 62 shows that:

- For the slot spillway, piano keys spillways and 90% of FSL start storage options, flooding in Rochester would likely still have been worse than experienced in 2011
- Flooding would have been near, but probably slightly below the major flood threshold with the spillway gates option, or if the Lake Eppalock start storage was 70% of FSL.
- Of the options tested, only the 50% of FSL start storage would have avoided flooding in Rochester.

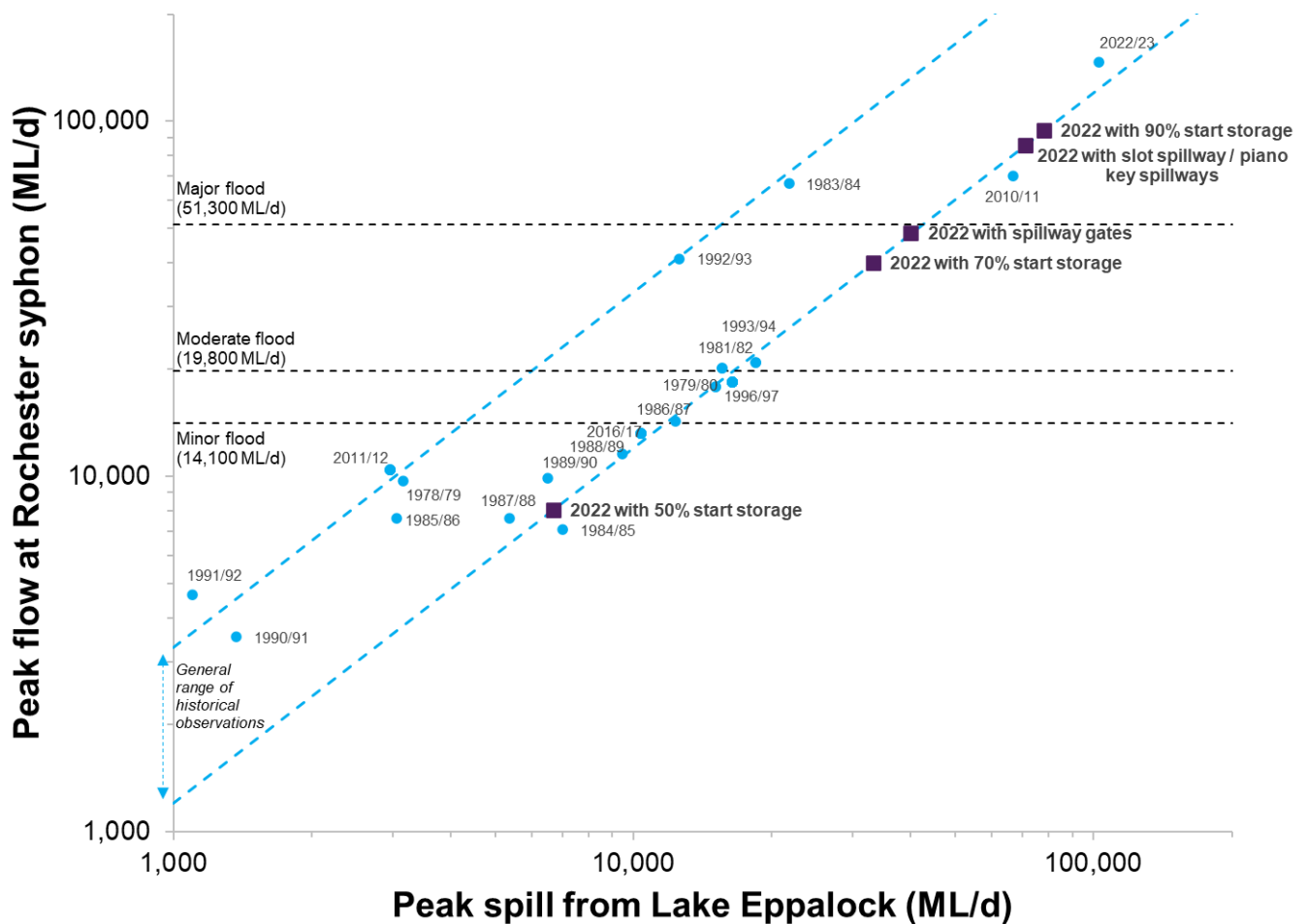

Figure 62: An indicative assessment of how the 2022 flood at Rochester may have differed if some of the considered options were in place. A 90%, 70% or 50% start storage would only have been achievable with an increased outlet capacity.

### 11.2.2 Flood damages

The method described in Appendix D was used to approximate how tangible flood damages from Lake Eppalock to Rochester vary according to the peak spill from storage<sup>36</sup>. The results are shown in Figure 63, and demonstrate that most of the costs are incurred in Rochester. Table 30 shows the components that comprise the total values shown in Figure 63. Damages to residential structures become a larger component of total costs as the peak spill from Lake Eppalock increases.

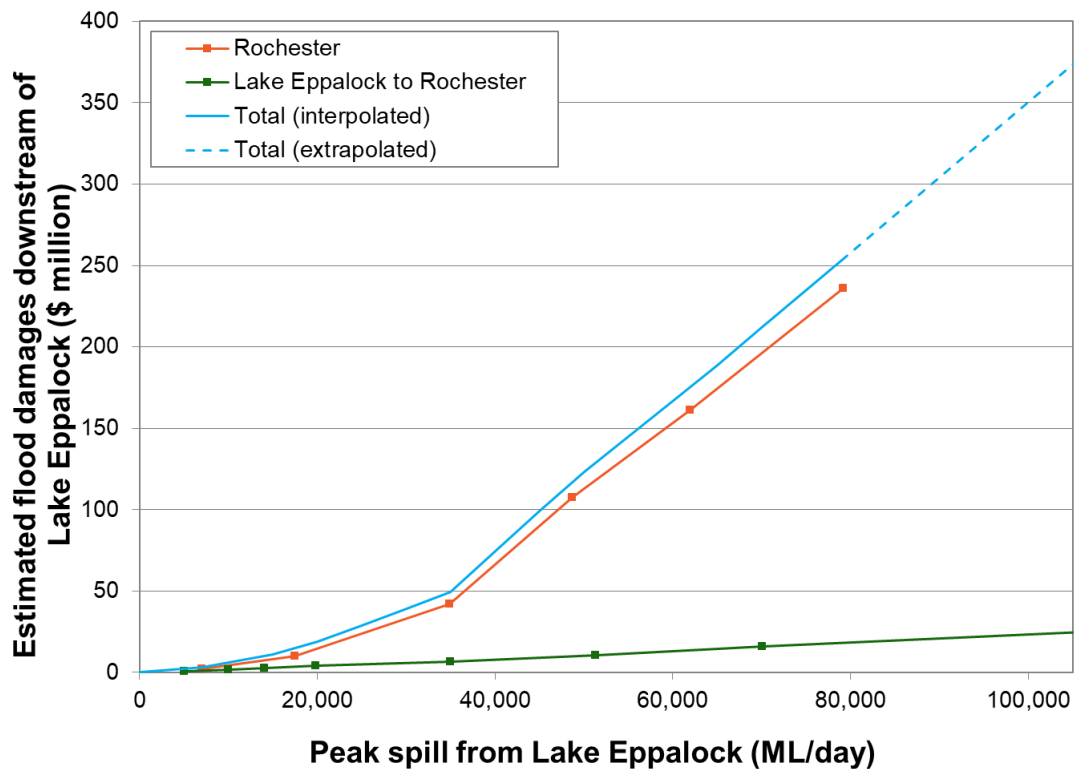

Figure 63: An indicative assessment of how tangible flood damages downstream of Lake Eppalock vary with peak spill from storage

Table 30: Elements of the estimated total flood damages shown in Figure 63

Approximate peak flow (ML/d)		Approximate flood damages from Eppalock to Rochester (\$ million) – number in brackets shows approximate number of houses affected					
Eppalock spill	Rochester syphon	Residential structures	Non-residential structures	Roads	Agriculture	Indirect costs	Total
7,000	8,400	(0) 0.0	0.4	1.6	0.3	0.7	3.1
17,000	20,400	(40) 2.6	1.7	5.3	0.9	3.1	13.6
35,000	42,000	(400) 20.0	3.4	12.3	1.7	11.2	48.7
49,000	58,800	(1000) 55.5	9.8	22.5	2.5	27.1	117.5
62,000	74,400	(1500) 84.9	15.7	30.7	3.1	40.3	174.8
79,000	94,800	(2000) 127.5	22.8	41.7	3.2	58.6	253.8

<sup>36</sup> This analysis does not account for the intangible damages caused by flooding, such as mental health impacts for individuals, or unwanted changes to community dynamics



Figure 64 combines the information from Figure 61, Figure 62 and Figure 63 to provide an indicative assessment of how tangible flood damages from Lake Eppalock to Rochester would differ if the 2011 or 2022 floods were repeated but the options described in Section 4 were in place. If spillway gates or the piano key spillways options were implemented, there would also be increased flood damages upstream of Lake Eppalock during a repeat of 2011 or 2022, because of the higher peak reservoir level (Figure 65). Values from Figure 64 and Figure 65 are summarised in Table 31.

Table 31: A summary of how the options described in Section 4 would reduce the flood damages if the 2011 or 2022 events were repeated. A 90%, 70% or 50% start storage would only have been achievable with an increased outlet capacity.

Option	Approximate peak flow (ML/d)		Approximate flood damages (in millions)			
	Eppalock spill	Rochester syphon	Upstream of Eppalock	Eppalock to Rochester*	Total (rounded)	Difference v base case
2011 – base case	70,000	^84,000	\$7	(1700) \$200	\$205	-
2011 – 50% start storage	7,000	8,500	-	~\$0	~\$0	\$205
2011 – 70% start storage	17,500	21,000	-	(50) \$15	\$15	\$190
2011 – 90% start storage	32,000	38,500	-	(340) \$40	\$40	\$165
2011 – spillway gates	40,000	48,000	\$15	(600) \$75	\$90	\$115
2011 – slot spillway at 70%	44,000	52,800	-	(800) \$95	\$95	\$110
2011 – piano key spillways	44,000	52,800	\$20	(800) \$95	\$115	\$90
2022 – base case	103,000	^123,500	\$15	(>2000) \$360	\$375	-
2022 – 50% start storage	7,000	8,500	-	~\$0	~\$0	\$375
2022 – 70% start storage	33,000	39,500	-	(360) \$45	\$45	\$330
2022 – 90% start storage	78,000	93,500	\$8	(1970) \$250	\$260	\$115
2022 – spillway gates	40,000	48,000	\$25	(600) \$75	\$100	\$275
2022 – slot spillway at 70%	71,000	85,000	-	(1800) \$220	\$220	\$155
2022 – piano key spillways	71,000	85,000	\$30	(1800) \$220	\$250	\$125

^ To consistently relate the peak spill from Lake Eppalock to an approximate peak flow at Rochester syphon, the lower blue-dotted lines shown in Figure 61 and Figure 62 have been used. This means the values here are different to those recorded at the Rochester syphon gauge in 2011 (~70,000 ML/d) and 2022 (~140,000 ML/d).

\* The values in brackets are the approximate number of houses affected downstream of Lake Eppalock, with these numbers estimated by interpolating between the values shown in Table 30.

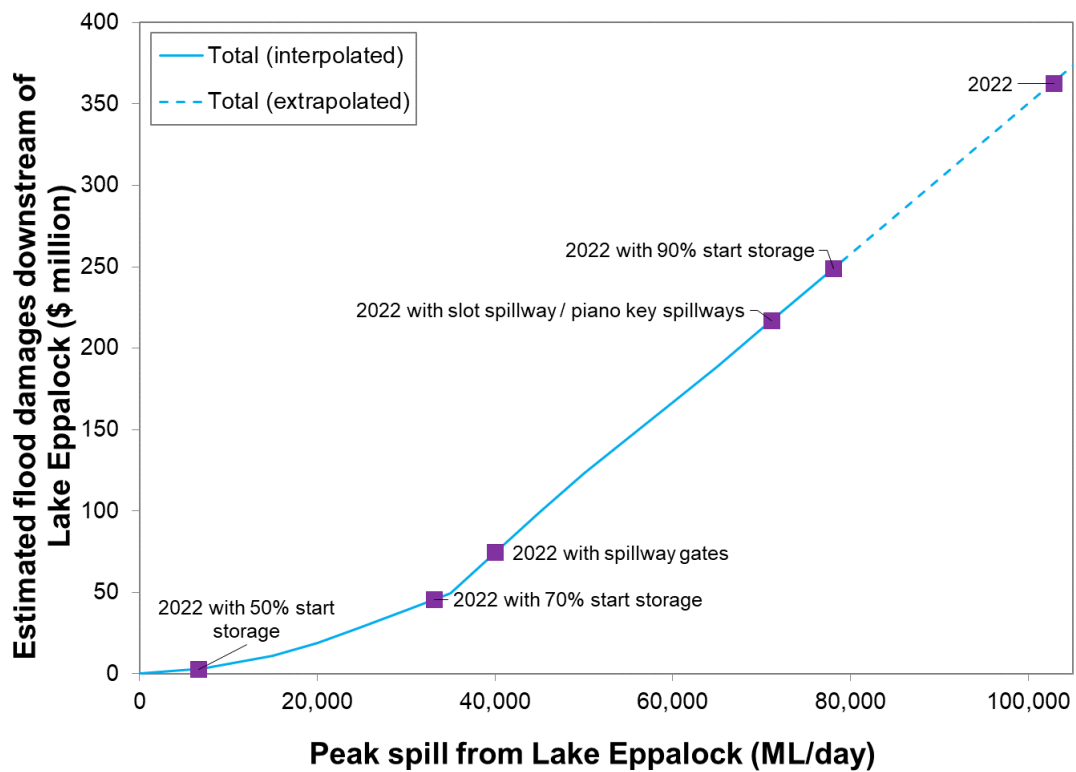
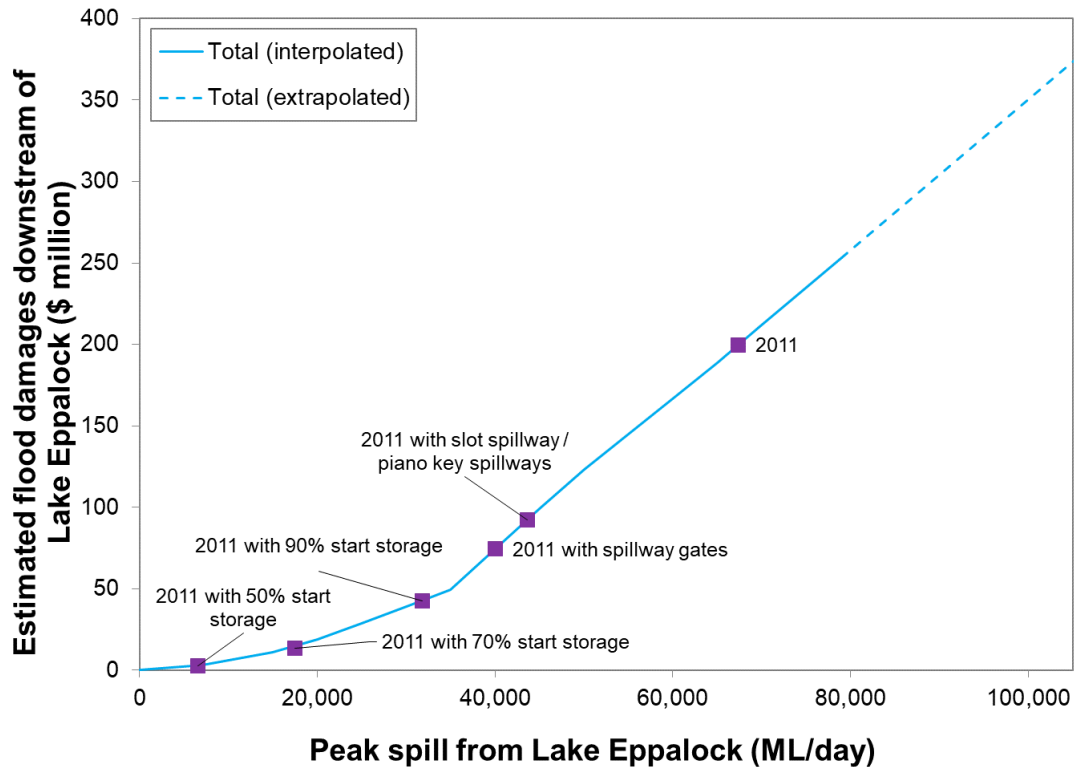

Figure 64: An indicative assessment of how tangible flood damages from Lake Eppalock to Rochester would differ if the 2011 (top) or 2022 (bottom) floods were repeated but with the options described in Section 4 in place. A 90%, 70% or 50% start storage would only have been achievable with an increased outlet capacity.

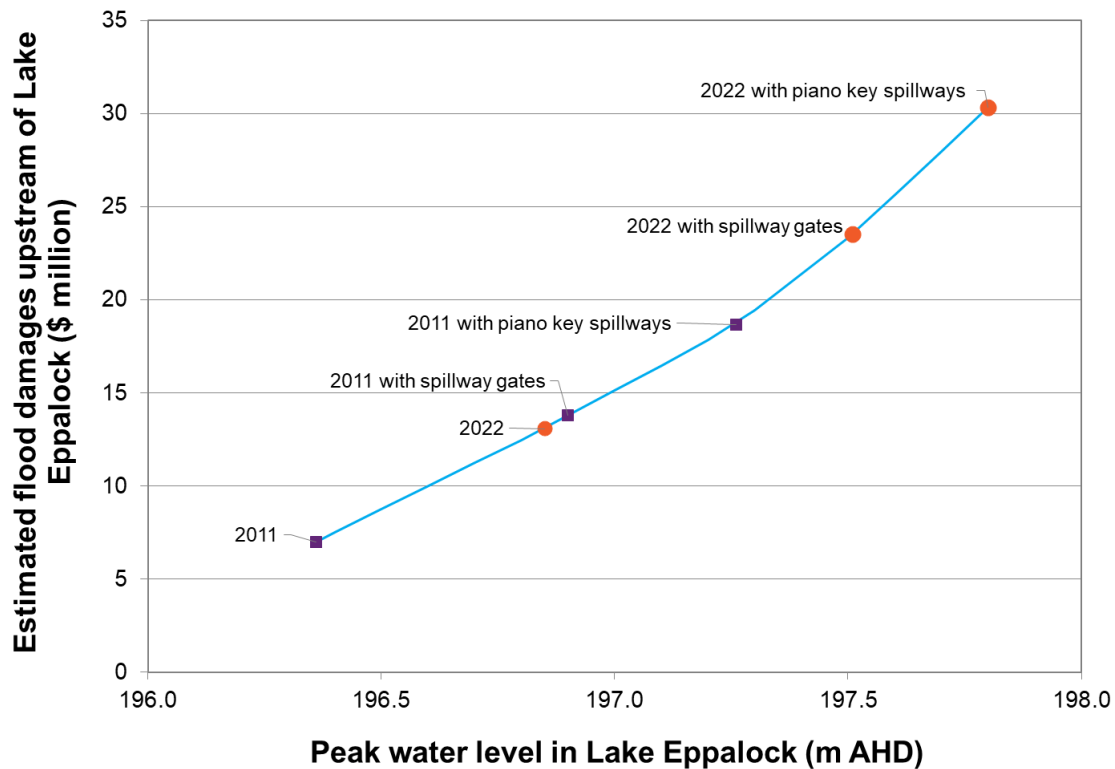

Figure 65: An indicative assessment of how tangible flood damages upstream of Lake Eppalock would increase if the 2011 or 2022 floods were repeated but with the spillway gates or piano key spillways options in place

Figure 66 combines the information in Section 8.3 with the flood damage assessment results described above, to show the approximate initial capital costs versus approximate reduction in tangible flood damages for peak outflows with an estimated AEP of 5%, 1% and 0.2%<sup>37</sup> (top) and those experienced in 2011 and 2022 (bottom). If an option is plotted below the 1:1 dotted line, the estimated reduction of flood damages if that same event were to occur again<sup>38</sup> is greater than the approximate initial capital cost. This comparison shows that:

- The extent of avoided damages varies by both the flood magnitude and option. This means that if any of the options considered were to be implemented, the time to recoup the costs in the form of avoided damages will depend on the timing and magnitude of future flooding along the Campaspe River.
- Compared to the spillway gates and piano keys spillways options, the options to reduce the target storage or FSL using an increased outlet capacity or spillway slot generally have relatively high ratios of avoided damages to initial capital cost. However, the estimated costs do not include the ongoing socio-economic consequences of reducing the volume of water stored in the Campaspe system, and the recreational impacts of holding the Lake Eppalock water level below the current FSL.

<sup>37</sup> Assuming the relationship between peak outflows from Lake Eppalock and the peak flow at Rochester syphon is as per the lower blue-dashed line in Figure 61 and Figure 62

<sup>38</sup> The estimated frequency of different flood magnitudes is accounted for in the ranking of options discussed in Section 11.3

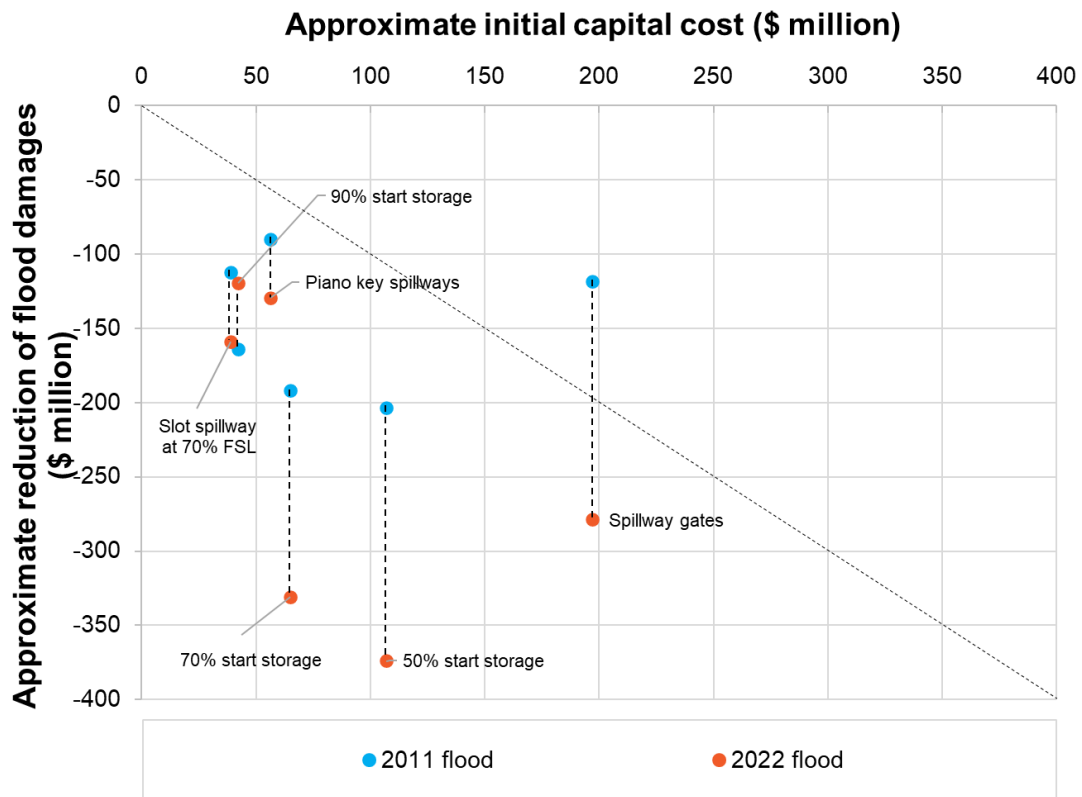
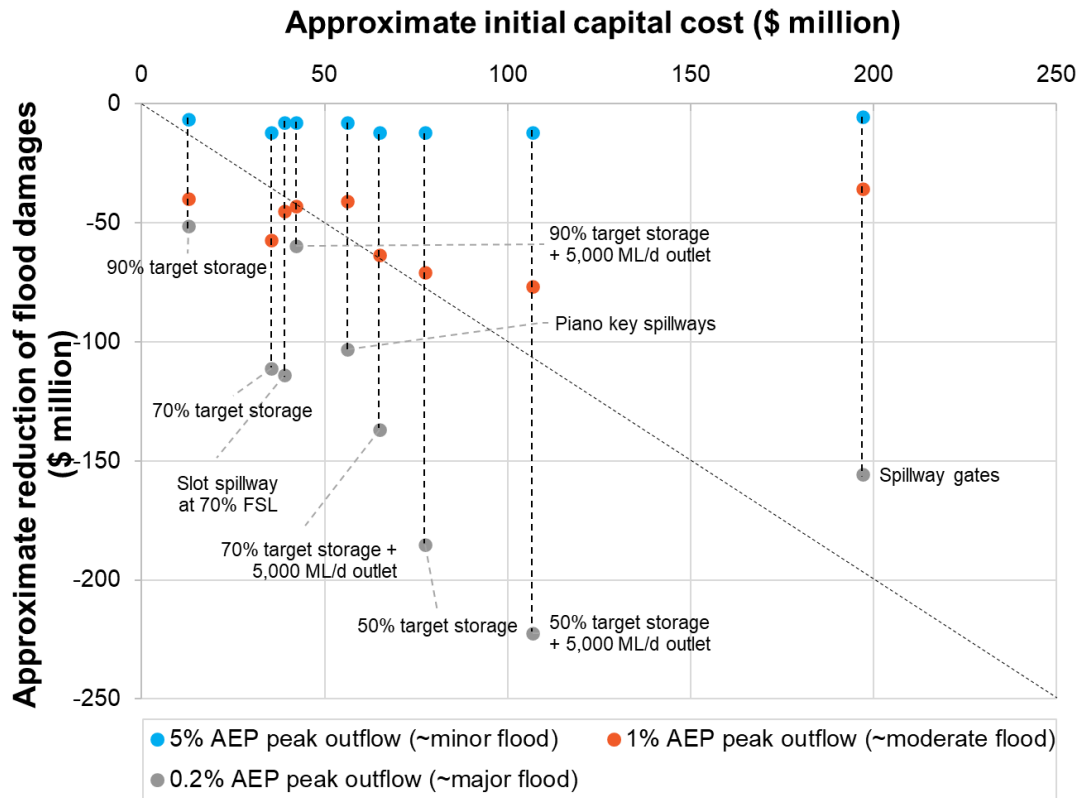

Figure 66: Approximate initial capital costs versus approximate reduction in tangible flood damages resulting from peak outflows from Lake Eppalock that have an estimated AEP of 5%, 1% and 0.2% (top) and those experienced in 2011 and 2022 (bottom). In 2011 and 2022, a 90%, 70% or 50% start storage would only have been achievable with increased outlet capacity.





Table 32: A summary of the values shown in the top section of Figure 66.

Flood class outflow (at Eppalock) – Option	Approximate peak flow (ML/d)		Approximate value (in millions)		Ratio
	Eppalock spill	Rochester syphon	Reduction in flood damage	Initial capital cost	
<i>5% AEP peak outflow (minor flood in base case)</i>					
Base case	^22,700	27,200	-	-	-
90% target storage	19,200	23,000	\$5	\$15	0.3 : 1
90% target storage + 5,000 ML/d outlet	18,300	22,000	\$8	\$45	0.2 : 1
Slot spillway at 70% FSL	18,300	22,000	\$8	\$40	0.2 : 1
Spillway gates	20,000	24,000	\$5	\$200	0.03 : 1
Piano key spillways	18,300	22,000	\$8	\$60	0.1 : 1
70% target storage	15,600	18,700	\$10	\$35	0.3 : 1
70% target storage + 5,000 ML/d outlet	15,600	18,700	\$10	\$65	0.2 : 1
50% target storage	15,600	18,700	\$10	\$75	0.1 : 1
50% target storage + 5,000 ML/d outlet	15,600	18,700	\$10	\$105	0.1 : 1
<i>1% AEP peak outflow (moderate flood in base case)</i>					
Base case	^43,000	51,600	-	-	-
90% target storage	34,900	41,900	(340) \$40	\$15	2.7 : 1
90% target storage + 5,000 ML/d outlet	33,500	40,200	(370) \$40	\$45	0.9 : 1
Slot spillway at 70% FSL	32,500	39,000	(390) \$45	\$40	1.1 : 1
Spillway gates	31,700	38,000	(410) \$35	\$200	0.2 : 1
Piano key spillways	29,200	35,000	(460) \$40	\$60	0.7 : 1
70% target storage	26,500	31,800	(510) \$60	\$35	1.7 : 1
70% target storage + 5,000 ML/d outlet	23,500	28,200	(570) \$65	\$65	1.0 : 1
50% target storage	19,800	23,800	(650) \$70	\$75	0.9 : 1
50% target storage + 5,000 ML/d outlet	15,900	19,100	(710) \$75	\$105	0.7 : 1
<i>0.2% AEP peak outflow (major flood in base case)</i>					
Base case	^80,000	96,000	-	-	-
90% target storage	69,300	83,200	(310) \$50	\$15	3.3 : 1
90% target storage + 5,000 ML/d outlet	67,500	81,000	(370) \$60	\$45	1.3 : 1
Slot spillway at 70% FSL	56,900	68,300	(730) \$115	\$40	2.9 : 1
Spillway gates	42,600	51,100	(1300) \$155	\$200	0.8 : 1
Piano key spillways	54,200	65,000	(830) \$105	\$60	1.8 : 1
70% target storage	56,400	67,700	(740) \$110	\$35	3.1 : 1
70% target storage + 5,000 ML/d outlet	51,600	61,900	(930) \$135	\$65	2.1 : 1
50% target storage	41,500	49,800	(1350) \$185	\$75	2.5 : 1
50% target storage + 5,000 ML/d outlet	32,800	39,400	(1670) \$220	\$105	2.1 : 1

^ These values are lower than quoted by HARC (2017) for the associated AEP, because the base case Lake Eppalock drawdown distribution provided by DEECA for this study differs to the drawdown distribution used by HARC (2017)

\* The values in brackets are the approximate reduction in the number of houses affected downstream of Lake Eppalock, with these numbers estimated by interpolating between the values shown in Table 30



Table 33: A summary of the values shown in the bottom section of Figure 66. A 90%, 70% or 50% start storage would only have been achievable with an increased outlet capacity

Event – Option	Approximate peak flow (ML/d)		Approximate value (in millions)		Ratio
	Eppalock spill	Rochester syphon	Reduction in flood damage	Initial capital cost	
2011 – base case	70,000	^84,000	-	-	-
2011 – 50% start storage	7,000	8,400	(1700) \$205	\$105	2.0 : 1
2011 – 70% start storage	17,500	21,000	(1650) \$190	\$65	2.9 : 1
2011 – 90% start storage	32,000	38,400	(1400) \$165	\$45	3.7 : 1
2011 – spillway gates	40,000	48,000	(1100) \$115	\$200	0.6 : 1
2011 – slot spillway at 70%	44,000	52,800	(900) \$110	\$40	2.8 : 1
2011 – piano key spillways	44,000	52,800	(900) \$90	\$60	1.5 : 1
2022 – base case	103,000	^123,600	-	-	-
2022 – 50% start storage	7,000	8,400	(>2000) \$375	\$105	3.6 : 1
2022 – 70% start storage	33,000	39,600	(>1600) \$330	\$65	5.1 : 1
2022 – 90% start storage	78,000	93,600	(>30) \$115	\$45	2.6 : 1
2022 – spillway gates	40,000	48,000	(>1400) \$275	\$200	1.4 : 1
2022 – slot spillway at 70%	71,000	85,200	(>200) \$155	\$40	3.9 : 1
2022 – piano key spillways	71,000	85,200	(>200) \$125	\$60	2.1 : 1

\* To consistently relate the peak spill from Lake Eppalock to an approximate peak flow at Rochester syphon, the lower blue-dotted lines shown in Figure 61 and Figure 62 have been used. This means the values here are different to those recorded at the Rochester syphon gauge in 2011 (~70,000 ML/d) and 2022 (~140,000 ML/d).

\* The values in brackets are the approximate reduction in the number of houses affected downstream of Lake Eppalock, with these numbers estimated by interpolating between the values shown in Table 30

### 11.3 Options ranking (avoided damages vs initial capital cost)

The outflow flood frequency curves from Section 6.4 and Section 6.5 were combined with the Lake Eppalock peak spill vs downstream damage curve (Figure 63) and peak reservoir level vs upstream damage curve (Figure 65) to estimate the average annual damages (AAD) for the base case and each option. The results are summarised in Table 34.

These values are approximate because:

- The relationship between spills from Lake Eppalock and flood damages from Lake Eppalock to Rochester is approximate, and has been extrapolated (Figure 63).
- Flood damages downstream of Rochester have not been considered.
- Damages avoided by reducing the target storage using the existing outlet capacity are likely to be overstated, for the reasons discussed in Section 7.2.1.
- Estimates of AAD will increase once the flood hydrology and hydraulic modelling is updated using rainfall, streamflow and inundated area records available for the October 2022 event.



Table 34: Estimates of average annual flood damages under the base case and options assessed. The limitations of these estimates are listed above.

Option	Approximate average annual damages (\$ millions)		
	Upstream	Downstream	Total
Base case	0.3	4.4 – 5.6	4.7 – 6.0
90% target storage	0.2 – 0.3	3.2 – 4.0	3.5 – 4.3
90% target storage + 5,000 ML/d outlet	0.2	3.0 – 3.5	3.3 – 3.7
Slot spillway at 70% FSL	0.0 – 0.1	2.7 – 3.4	2.7 – 3.5
Spillway gates	0.4 – 0.5	2.8 – 2.9	3.2 – 3.4
Piano key spillways	0.6 – 0.7	2.5 – 3.2	3.1 – 3.9
70% target storage	0.1 – 0.2	2.2 – 2.3	2.3 – 2.5
70% target storage + 5,000 ML/d outlet	0.1	1.9 – 2.0	2.0 – 2.1
50% target storage	0.1	1.6 – 1.7	1.7 – 1.8
50% target storage + 5,000 ML/d outlet	0.1	1.3 – 1.4	1.4 – 1.5

Table 35 shows how the average annual damages avoided under each option (versus the base case) compares with the initial capital cost, if using a 50-year planning horizon with 6% discount rate. For the reasons stated below Table 35, the actual ratios of avoided damages to initial capital cost need to be used with caution, but the values show the relative order of options in terms of benefit versus cost. The rows in Table 35 have been colour-coded to demonstrate this order, namely:

- The options to reduce the target storage or FSL to 70% of the current FSL using an increased outlet capacity or passive spillway slot – shaded blue – have the best ratio of avoided damages to initial capital cost, on the assumption that the benefits from the reduced target storage with existing outlet options are overstated.
- The options to reduce the target storage to 50% or 90% of the current FSL using an increased outlet capacity – shaded yellow – have a lower benefit : cost ratio compared with the 70% option. Further work would be required to find the optimal reduced target storage or FSL, but the values in Table 35 suggest it is likely to be in the order of 70% of the current FSL. This conclusion however, does not account for the ongoing socio-economic consequences of reducing the volume of water stored in the Campaspe system, and the recreational impacts of holding the Lake Eppalock water level below FSL.
- The options to maintain the current FSL at Lake Eppalock and either add spillway gates to the primary spillway or piano keys to the primary and secondary spillways, has a relatively low benefit : cost ratio. The ratio is likely to increase once the flood hydrology and hydraulic modelling is updated using rainfall, streamflow and inundated area records available for the October 2022 event, but for the spillway gates option this expected increase will be somewhat offset if additional ongoing maintenance costs are accounted for.
- The reduced target storage with existing infrastructure options have been ignored in the ranking of options for the reasons discussed in Section 7.2.1.



Table 35: Estimates of avoided damages vs initial capital cost, assuming a 50-year horizon, a 6% discount rate and ignoring any increase in operation and maintenance costs. Colours have been added to the rows to illustrate the relative order of benefit : cost ratios for the various options.

Option	Approximate benefit-cost (50 years, 6% discount)		
	Avoided damages (\$ m) <sup>^</sup>	Initial capital cost (\$ m) <sup>*</sup>	Ratio
Slot spillway at 70% FSL	30.3 – 39.3	40	0.8 – 1.0
70% target storage + 5,000 ML/d outlet	41.8 – 60.8	65	0.6 – 0.9
90% target storage + 5,000 ML/d outlet	22.3 – 35.6	45	0.5 – 0.8
50% target storage + 5,000 ML/d outlet	51.2 – 71.2	105	0.5 – 0.7
Piano key spillways	24.5 – 32.4	60	0.4 – 0.5
Spillway gates	23.6 – 41.2	200	0.1 – 0.2
90% target storage	19.0 – 27.2	15	1.3 – 1.8
70% target storage	37.3 – 55.3	35	1.1 – 1.6
50% target storage	46.8 – 65.4	75	0.6 – 0.9

<sup>^</sup> The estimates of avoided damages are approximate, because:

- The relationship between spills from Lake Eppalock and flood damages from Lake Eppalock to Rochester is approximate, and has been extrapolated (Figure 63).
- Flood damages downstream of Rochester have not been considered.
- Damages avoided by reducing the target storage using the existing outlet capacity are likely to be overstated, for the reasons discussed in Section 7.2.1.
- Estimates of AAD will increase once the flood hydrology and hydraulic modelling is updated using rainfall, streamflow and inundated area records available for the October 2022 event.

<sup>\*</sup> For the estimates of costs:

- The design and construction costs for the works were estimated to a AACE Class 5 level, which are typically within -50% to +100% of the true cost.
- The costs associated with offsetting the supply reliability impacts are approximate, as discussed in Section 8.2.
- The ongoing socio-economic costs associated with reducing the volume of water stored in the Campaspe system (if the target storage or FSL at Lake Eppalock is reduced) are not included.
- The additional operation and maintenance costs of new infrastructure are not included.



## 12. Conclusion

This assessment of potential operating and infrastructure options for increasing the flood mitigation provided by Lake Eppalock has examined five options:

- Three of the options involve reducing the target storage or FSL at Lake Eppalock
- Two of the options would maintain the existing FSL at Lake Eppalock, but temporarily store more water behind the dam wall during floods

For each option, the water resource implications, flood frequency changes at Lake Eppalock, anticipated changes to 2011 and 2022 spills from Lake Eppalock (if the events were repeated), concept designs and initial capital costs, upstream water level implications, downstream flow regime changes, and potential reductions of tangible flood damages have been considered.

The options with the best ratio of avoided flood damages to initial capital cost are lowering the target storage or FSL to 70% of the current FSL using an increased outlet capacity or passive spillway slot. However, the ongoing socio-economic consequences of reducing the volume of water stored in the Campaspe system, and the recreational impacts of holding the Lake Eppalock water level below FSL, have not been accounted for. Therefore, before one or more option is selected as the preferred option(s) for further investigation:

- Results from this technical assessment will need to be compared with outcomes from the update of the Rochester flood management plan that is underway.
- The socio-economic consequences of reducing the volume of water stored for entitlement holders in the Campaspe system need to be modelled.
- An assessment – informed by consultation with entitlement holders – is needed about the mechanisms available to change water sharing arrangements, to allow airspace to be maintained in Lake Eppalock without reducing water supply reliability and/or compromising water pricing in the Campaspe system.

If changing the water sharing arrangements in the Campaspe system is not feasible, then the options to reduce the target storage or FSL at Lake Eppalock are not worth pursuing further. If the arrangements can be changed, further work is required to optimise the trade-off between the socio-economic, recreational, environmental and cultural consequences of reducing the target storage / FSL, and the additional flood mitigation provided.

If all existing entitlements in the Campaspe system are retained with their current reliability of supply, only the options to add gates or piano keys to the spillways are plausible ways to increase the flood mitigation provided by Lake Eppalock. Both options have a relatively low ratio of avoided flood damages to initial capital cost. The spillway gates option would also increase the operational costs and risks at Lake Eppalock<sup>39</sup>. The operational costs would include maintenance of the new infrastructure, and additional staffing to forecast inflows and make reservoir surcharge decisions during floods.

---

<sup>39</sup> Assessing these operational costs and risks was not within the scope of this study

The risks associated with spillway gate operation decisions during floods are well-demonstrated by the class action following the 2011 Queensland floods. And closer to Lake Eppalock, the challenges of balancing water security and flood mitigation via the operation of spillway gates is illustrated by Victorian flood inquiry submissions related to the October 2022 floods downstream of the gated Lake Eildon in the Goulburn River catchment<sup>40</sup>. In summary, adding spillway gates to Lake Eppalock will increase the potential flood mitigation for those living downstream, but also increase risks borne by the storage manager.

If the spillway gates or piano keys spillways options are considered suitable for further investigation, additional work will need to be done to optimise the engineering design, so that the infrastructure provides an appropriate trade-off between costs, the upstream impacts from increased reservoir levels, and the additional flood mitigation for the downstream community.

The option to reduce the target storage at Lake Eppalock using the existing infrastructure is not a robust way of increasing the flood mitigation provided by the storage. For example, in 2011 and 2022 inflows in the months prior to the floods were such that the storage could not have been held at a defined target (e.g. 70% or 90% of FSL) before either event. Likewise, releasing water from storage in response to rainfall forecasts will not be a feasible way of significantly reducing flood frequencies downstream of Lake Eppalock until there is a noticeable reduction in forecast uncertainties. Significant improvement in rainfall forecasts relevant to dam operations is not expected in the near term (DELWP, 2022).

**These conclusions also need to be read with the following caveats in mind:**

Given the time available for this study, existing models were used as made available by DEECA and GMW. When these models are updated in future (for example by calibrating the RORB model to October 2022 flood records), the results presented in this report will become superseded.

Costs for the options investigated were estimated to a level commensurate with AACE Class 5, which is appropriate for strategic planning and concept screening. AACE Class 5 estimates are typically within -50% to +100% of the true cost. In addition, only initial capital costs were considered. The ongoing socio-economic costs if the target storage or FSL at Lake Eppalock is reduced, and the operation and maintenance costs of new infrastructure, have not been accounted for.

This report links peak spills from Lake Eppalock with peak flows at Rochester syphon using a relationship fitted to gauged flows at both locations post-1975. However, the correlation between Lake Eppalock spills and flooding in Rochester is not perfect. This is because there is approximately 1,370 km<sup>2</sup> of catchment area between Lake Eppalock and Rochester. If during future events the highest rainfall occurs downstream rather than upstream of the dam, Rochester will be susceptible to flooding regardless of the operating or infrastructure options implemented at Lake Eppalock.

---

<sup>40</sup> <https://new.parliament.vic.gov.au/floodinquiry>

The method used to link peak spills from Lake Eppalock with peak flows at Rochester syphon also means that when a more detailed approach is used to assess any of the operating and infrastructure options considered here – for example during the update of the Rochester flood management plan – the predicted reduction in flood damages will be different to the values included in this report.

The potential for operating and infrastructure options to increase the flood mitigation provided by Lake Eppalock has been assessed in this study using both a joint-probability and event-based approach to simulating floods. This has demonstrated that the additional flood mitigation from each option varies depending on the specific nature of the flood (e.g. peak, volume, sequencing), and the relative differences between options will therefore vary by event.

The estimates of avoided flood damages included in this report are approximate. This is because a) the relationship between spills from Lake Eppalock and flood damages from Lake Eppalock to Rochester is approximate, and has been extrapolated; b) flood damages downstream of Rochester have not been considered; c) damages avoided by reducing the target storage using the existing outlet capacity are likely to be overstated; d) estimates of average annual damages will increase once the supporting flood hydrology and hydraulic modelling is updated.

The modelling of how the Lake Eppalock storage trace would behave with a reduced target storage or FSL, and hence affect downstream flood frequencies, was done prior to the assessment of the water recovery required to offset the reliability impacts. If the volume of water shares in the Campaspe system was reduced, this in turn would change the demand for water and hence the storage trace. Therefore, iterative modelling would be required to gain a more precise estimate of the increased flood mitigation vs water recovery applicable for a given target storage or reduced FSL. This type of iteration has not been completed as part of this technical assessment.

Finally, this assessment has been informed by datasets and models that represent historic climate conditions, either over the full period of record or post-1975. Appendix E provides some commentary on how future climate change may influence the hydrological behaviour of the Campaspe system, and the effectiveness of the potential operating and infrastructure options for increasing the flood mitigation provided by Lake Eppalock. In summary, the most recent research suggests that as the climate warms there will be reduced water availability in the Campaspe system, and worse flooding because of increased rainfall intensities. However, the range of potential changes to rainfall and runoff in response to a warmer climate is large, and therefore it will be important to also consider the future adaptability of the options when one or more is selected as the preferred option(s) for further investigation.

### **Recommended further work**

Before further work is done on the potential operating and infrastructure options for increasing the flood mitigation provided by Lake Eppalock, the RORB model of the catchment and dam should be re-calibrated and re-verified using rainfall and streamflow records available for the 2022 flood. DEECA should also consider using the daily Goulburn-Broken-Campaspe-Coliban-



Loddon Source model during future assessments of the water resource and downstream flow regime implications, rather than continuing to use the monthly Goulburn Simulation Model that was made available for this study.

If the water sharing arrangements in the Campaspe River catchment are able to be changed, further work will be required to optimise the trade-off between the socio-economic, recreational, environmental and cultural consequences of reducing the target storage / FSL, and the additional flood mitigation provided. This includes:

- Modelling the socio-economic consequences of reducing the volume of water stored in the Campaspe system
- Assessing the costs and benefits of different potential ways for recovering water shares
- Refining the assessment of flood damages, and how these vary according to peak outflows from Lake Eppalock
- Refining the initial assessments of the expected costs and benefits to existing recreational, environmental and cultural values around Lake Eppalock and downstream
- Refining the design and cost estimates for the increased outlet capacity, and optimising the outlet size by balancing the associated cost with the flood mitigation and operational benefits provided by the increased capacity.

If the water sharing arrangements cannot be changed and therefore only infrastructure options are possible for increasing the flood mitigation provided by Lake Eppalock, additional work will be required to optimise the design of the spillway gates or piano key spillways, to provide the best possible trade-off between costs, the upstream impacts from increased reservoir levels, and the additional flood mitigation for the downstream community. However, even with further optimisation, the implementation costs for these two options are likely to be greater than estimates of flood damages avoided over a 50-year timespan.

Regardless of the option(s) selected for further investigation, it is also recommended that the option(s) be stress-tested using additional long-term and short-term climate sequences that are indicative of potential future conditions in the Campaspe River catchment.





## 13. References

- ANCOLD (2003). *Guidelines on Risk Assessment*, October 2003.
- Ayre, R.A., Malone, T. and Ruffini, J.L. (2023). *Wivenhoe, January 2011: the dam truth*. Australasian Journal of Water Resources; <https://doi.org/10.1080/13241583.2023.2248676>
- DELWP (2020). *Guidelines for Assessing the Impact of Climate Change on Water Availability in Victoria*, November 2020.
- DELWP (2022). *Guideline for the use of rainfall forecasts to make releases from dams in Victoria*, April 2022.
- GMW (2011). *Eppalock Airspace Considerations: Further Details*. Briefing paper (draft). TATDOC#3059508-v1.
- HARC (2017). *GMW Dams PRA Hydrology Review; Lake Eppalock*. Report prepared for Goulburn-Murray Water.
- HARC (2019). *GMW Dams PRA Project; Risk Assessment: Lake Eppalock*. Report prepared for Goulburn-Murray Water.
- HARC (2023). *Stage 1A of Victorian Constraints Measures Program; Synthesis report – Hydrology modelling*. Report prepared for the Department of Environment, Energy and Climate Action.
- Heitlinger, M., Moffatt, T.S. and Little, D.J. (1965). *Design and Construction of Eppalock Earth and Rockfill Dam, and Turbine Pumping Station, on the Campaspe River, Victoria*. The Journal of the Institution of Engineers, Australia, Oct - Nov, pp 325-356.
- Horne, A., Webb, J. A., Rumpff, L., Mussehl, M., Fowler, K. and John, A. (2020). *Kaiela (Lower Goulburn River) Environmental Flows Study*. Report prepared for Goulburn Broken Catchment Management Authority.
- Jacobs (2014). *Campaspe Flow Objectives; Revised environmental flow objectives for the Campaspe River*. Report prepared for North Central Catchment Management Authority.
- John, A. (2021). *Model development report; Simplified eco-hydrological modelling of the Goulburn River system*. University of Melbourne, January 2021.
- John, A., Horne, A., Nathan, R., Fowler, K., Webb, J. A. and Stewardson, M. (2021a). *Robust Climate Change Adaptation for Environmental Flows in the Goulburn River, Australia*. *Frontiers in Environmental Science*, 9, 573.
- John, A. P., Fowler, K., Nathan, R., Horne, A. and Stewardson, M. (2021b). *Disaggregated monthly hydrological models can outperform daily models in providing daily flow statistics and extrapolate well to a drying climate*. *Journal of Hydrology*, 598, 126471.
- John, A., Nathan, R., Horne, A., Fowler, K. and Stewardson, M. (2022). *Non-stationary runoff responses can interact with climate change to increase severe outcomes for freshwater ecology*. *Water Resources Research*, 58, e2021WR030192.
- Laurenson, E.M. and Mein, R.G. (1995). *RORB: Hydrograph Synthesis by Runoff Routing*, in *Computer Models in Watershed Hydrology*. V.P. Singh (ed.), Water Resources Publications, pp151-164.
- Machiels, O. (2012). *Experimental study of the hydraulic behaviour of Piano Key Weirs*, PhD Thesis ULgetd-09252012-224610, University of Liège (B).



Queensland Government (2007). *Queensland Urban Drainage Manual*, Volume 1, September 2007.

SES (2020). *Rochester Local Flood Guide*, September 2020.

SKM (2000). *Eppalock Dam: Review of Hydrologic Risk*. Report prepared for Goulburn-Murray Water.

SKM (2005). *Specifications: Remedial works on Secondary Embankment at Lake Eppalock*. Report prepared for Northern Constructions and Goulburn-Murray Water.

SKM (2012a). *Filling Curve Options for Lake Eppalock*. Report prepared for GWM.

SKM (2012b). *Review of storage spillway rating tables*. Report prepared for Goulburn-Murray Water.

State Rivers and Water Supply Commission (1947). *Utilization of the Waters of the Campaspe River; Eppalock Reservoir Enlargement General Report*.

State Rivers and Water Supply Commission (1959). *Utilization of the Waters of the Campaspe River; Eppalock Reservoir Enlargement*.

State Rivers and Water Supply Commission (1974). *Enlargement of Eppalock Reservoir*.

URS (2007). *Goulburn-Murray Water DIP Risk Assessment Project: Lake Eppalock Storage*. Report prepared for Goulburn-Murray Water.

Water Technology (2013). *Rochester Flood Management Plan*. Report prepared for North Central Catchment Management Authority and Campaspe Shire Council.

Water Technology (2018). *Rochester Mitigation Study*. Report prepared for Campaspe Shire Council.



## Appendix A General dam arrangements

Elevation (m AHD)	Storage* (GL)	Discharge* (m <sup>3</sup> /s)						
		Primary Spillway	Secondary Spillway	Tertiary Spillway	Short Bank	Long Bank	Dam Wall	Total
157.0	0	0	0	0	0	0	0	0
160.0	0.1	0	0	0	0	0	0	0
165.0	1.9	0	0	0	0	0	0	0
170.0	7.8	0	0	0	0	0	0	0
175.0	21.5	0	0	0	0	0	0	0
180.0	48.9	0	0	0	0	0	0	0
181.0	57.2	0	0	0	0	0	0	0
182.0	66.6	0	0	0	0	0	0	0
183.0	77.1	0	0	0	0	0	0	0
184.0	88.9	0	0	0	0	0	0	0
185.0	102.1	0	0	0	0	0	0	0
186.0	117.0	0	0	0	0	0	0	0
187.0	133.7	0	0	0	0	0	0	0
188.0	152.2	0	0	0	0	0	0	0
189.0	172.7	0	0	0	0	0	0	0
190.0	195.3	0	0	0	0	0	0	0
191.0	220.1	0	0	0	0	0	0	0
192.0	247.0	0	0	0	0	0	0	0
193.0	276.1	0	0	0	0	0	0	0
193.5	291.6	0	0	0	0	0	0	0
193.91	304.7	0	0	0	0	0	0	0
194.0	307.6	4	0	0	0	0	0	4
194.5	324.2	67	0	0	0	0	0	67
195.0	341.3	176	0	0	0	0	0	176
195.5	359.0	320	0	0	0	0	0	320
196.0	377.2	498	39	0	0	0	0	537
196.5	396.0	687	200	0	0	0	0	887
197.0	415.3	896	439	0	0	0	0	1,335
197.5	435.1	1,119	745	0	0	0	0	1,865
198.0	455.6	1,358	1,164	182	0	0	0	2,704
198.5	476.6	1,603	1,625	674	0	0	0	3,903
199.0	498.2	1,859	2,115	1,404	0	0	0	5,377
199.5	520.4	2,110	2,659	2,404	1	0	0	7,174
200.0	543.2	2,373	3,373	3,708	233	652	51	10,390
200.5	566.6	2,655	4,155	5,093	650	2,201	540	15,294
201.0	590.6	2,937	4,936	6,479	1,189	4,270	1,297	21,108

\* 1 GL = 1,000 ML and 1 m<sup>3</sup>/s = 86.4 ML/d

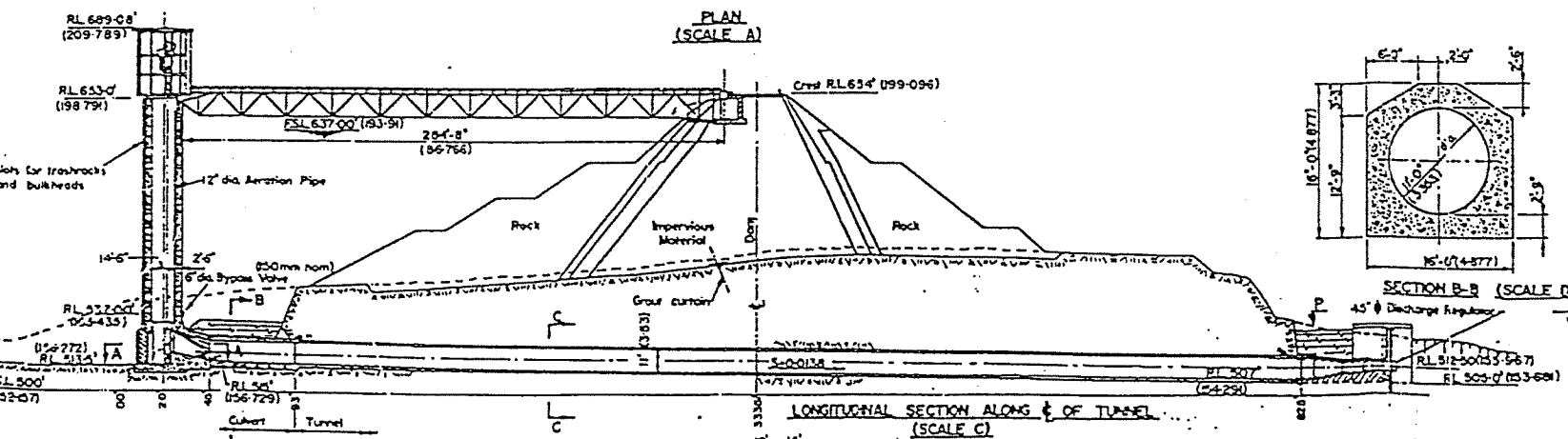
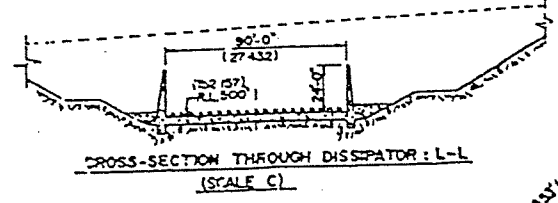
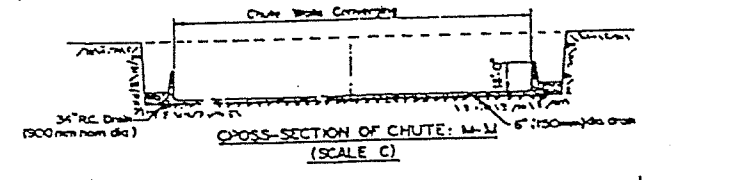
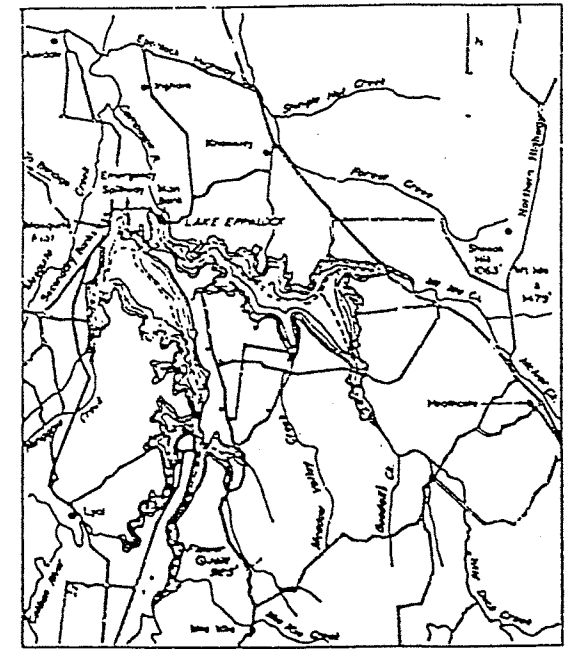
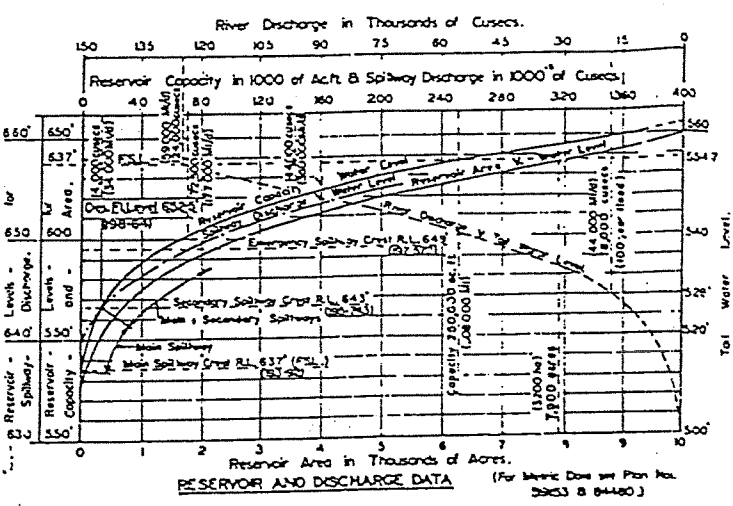
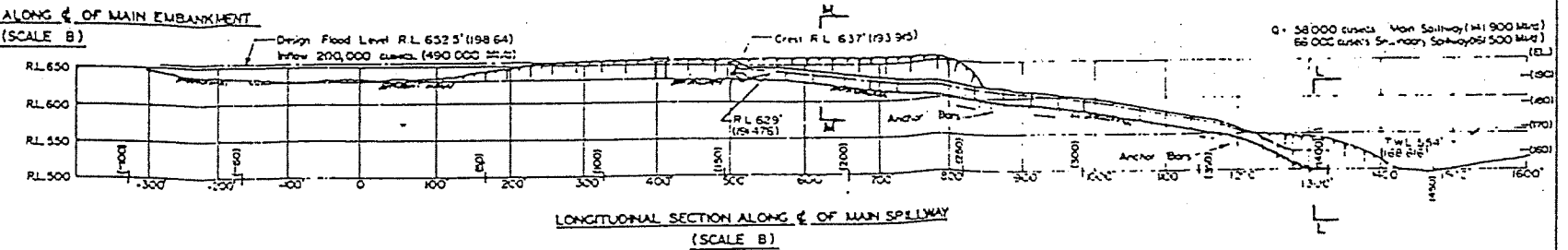
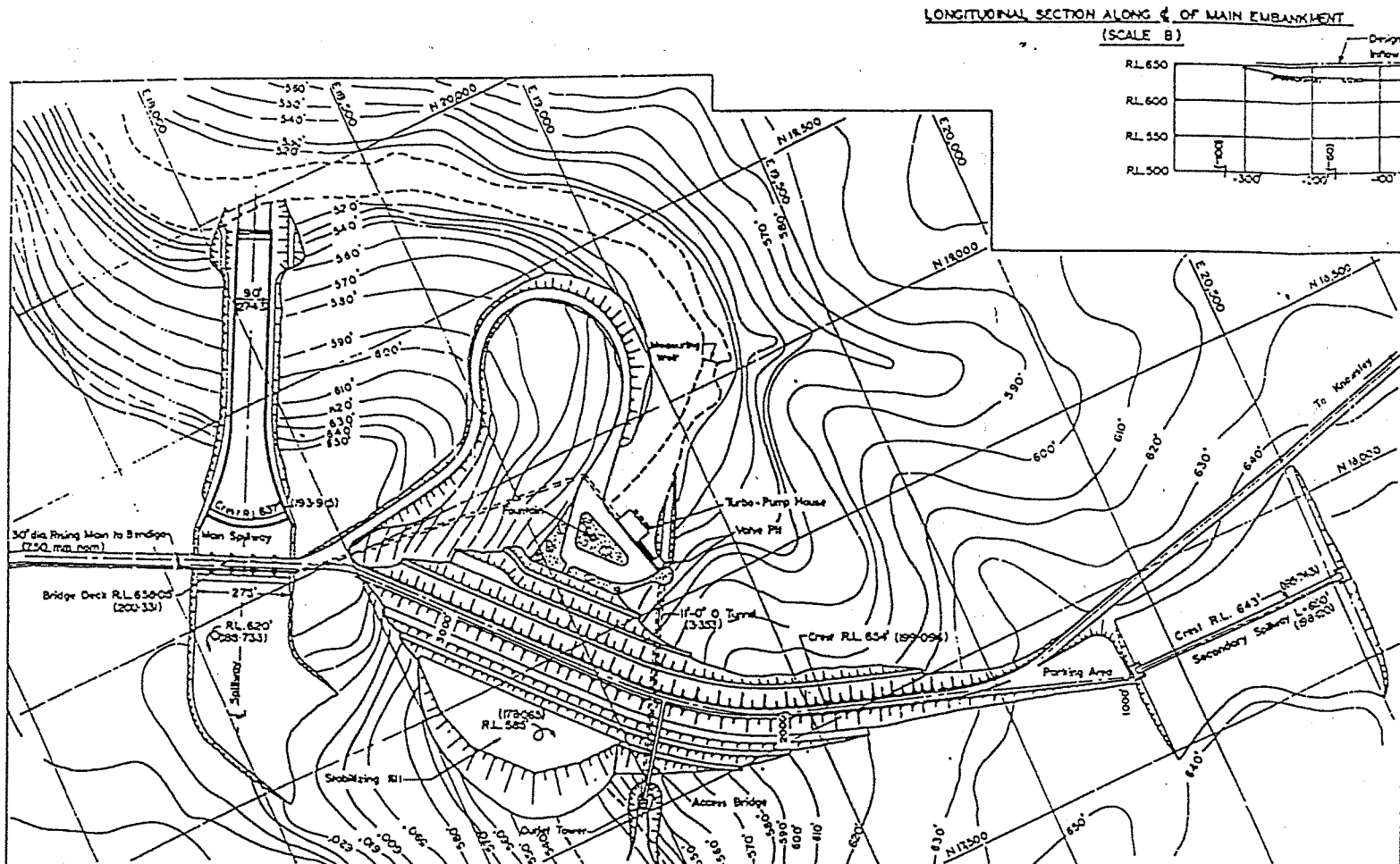
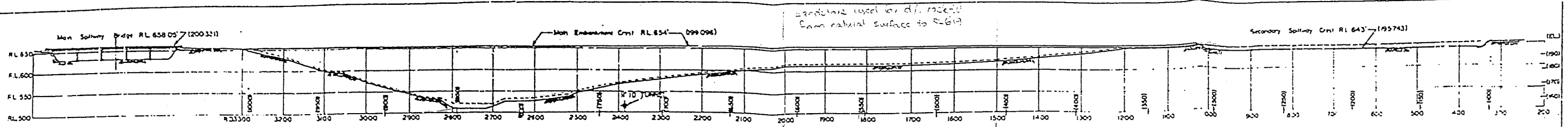

- NOTES
- All metric levels are to Australian High Water Datum (A.H.W.)
  - To obtain A.H.W. of Eppalock convert tropical levels to metric and deduct 0.243 (i.e. Crnl RL 654' = 199.096).
  - R.O.S., Contours, Orbits and grid are in feet.
  - For practical purposes, metric levels should be rounded to two decimal places.

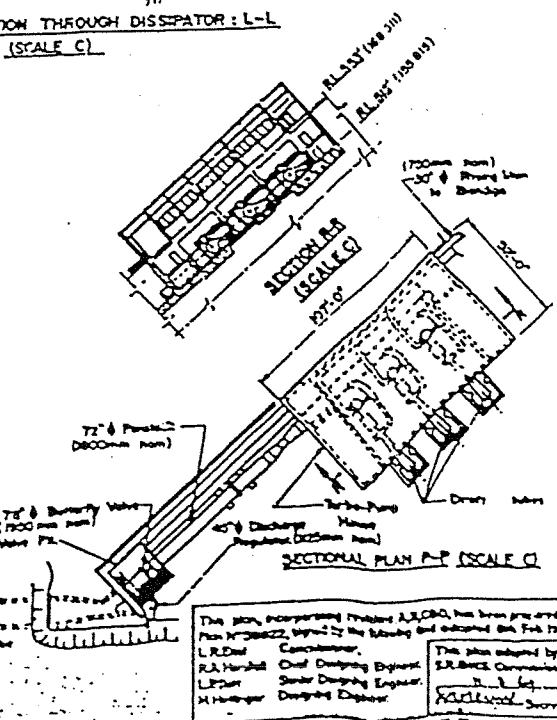
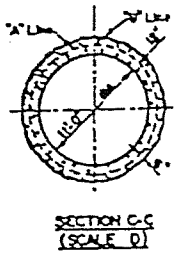
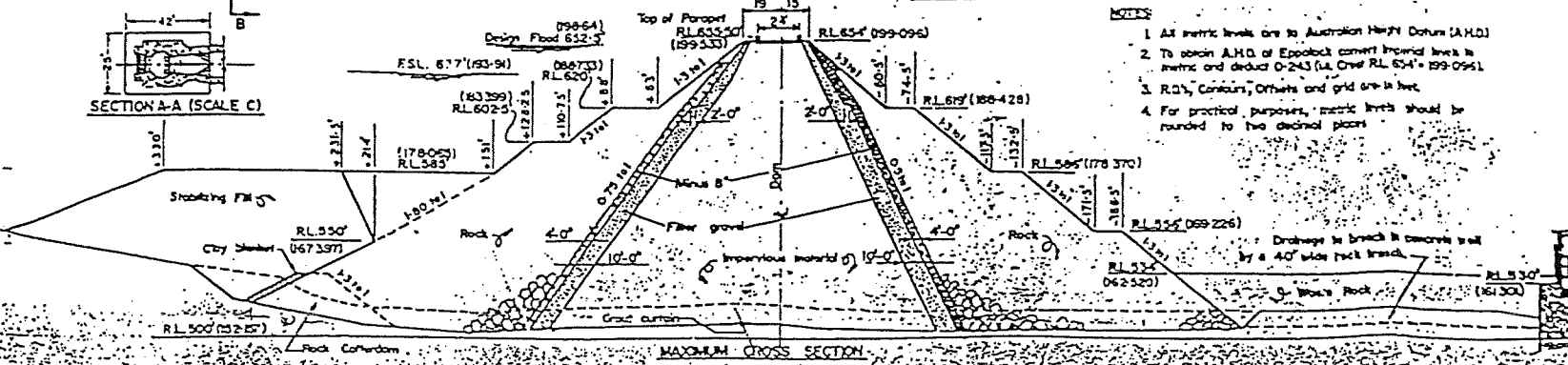

PLAN No.	TITLE	DATE	DESCRIPTION	APPROVED
59910	Layout of Spillway	1958	...	
59911	Arrangement of Main Dam and Adjacent Spillways	1958	...	
59934	Main Spillway Arrangement	1958	...	
59930	Head Water Arrangement	1958	...	
59926	Main Embankment Details	1958	...	

STATE RIVERS AND WATER SUPPLY COMMISSION

**EPPALOCK DAM**

**GENERAL ARRANGEMENT**

This plan, incorporating the above A.H.W., has been prepared from Plan No. 59922, issued by the Ministry and endorsed by the F.W.D., L.R.D. Commissioner.

Prepared by: R.A. Marshall, Chief Designing Engineer, L.P. Marshall, Senior Designing Engineer, M. Hanger, Designing Engineer.

Checked by: R.L. Marshall, L.P. Marshall, M. Hanger.

Approved by: R.L. Marshall, L.P. Marshall, M. Hanger.

Plan No. 59922E

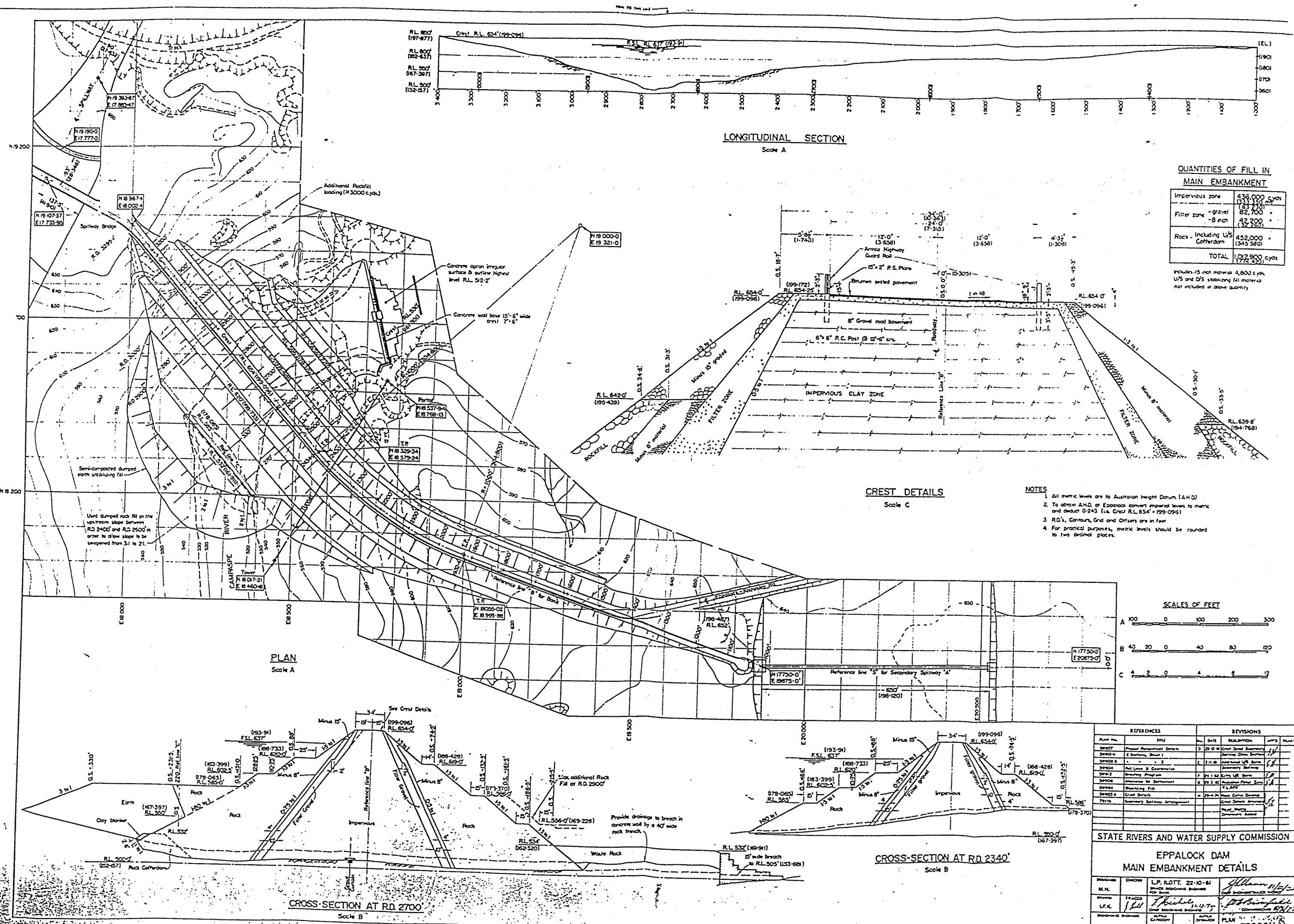

**LONGITUDINAL SECTION**  
Scale A

**QUANTITIES OF FILL IN MAIN EMBANKMENT**

Impervious zone	635,000 Cyds
Filter zone - gravel	82,700 "
Filter zone - 8 inch	42,200 "
Rock - Including U/S Cofferdam	452,000 "
<b>TOTAL</b>	<b>1,612,900 Cyds</b>

Includes 15 inch material 4,800 Cyds. U/S and O/S stabilizing fill material not included in above quantity.

**CREST DETAILS**  
Scale C

- NOTES**
- All metric levels are to Australian Height Datum (AHD)
  - To obtain AHD at Eppalock convert imperial levels to metric and deduct 0.243 (i.e. Crest R.L. 654' + 199-095)
  - R.O.'s, Contours, Grid and Offsets are in feet
  - For practical purposes, metric levels should be rounded to two decimal places.

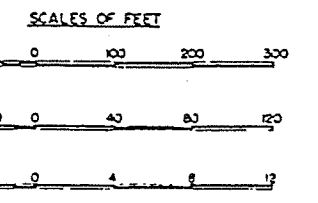

**PLAN**  
Scale A

**CROSS-SECTION AT RD 2340'**  
Scale B

**CROSS-SECTION AT RD 2700'**  
Scale B

PLAN No.	REV.	DATE	DESCRIPTION	BY	CHKD.
39907	1	03-04-64	Final Proposed Design	J.P. ROTT	J.P. ROTT
39908	1	03-04-64	Final Proposed Design	J.P. ROTT	J.P. ROTT
39909	1	03-04-64	Final Proposed Design	J.P. ROTT	J.P. ROTT
39910	1	03-04-64	Final Proposed Design	J.P. ROTT	J.P. ROTT
39911	1	03-04-64	Final Proposed Design	J.P. ROTT	J.P. ROTT
39912	1	03-04-64	Final Proposed Design	J.P. ROTT	J.P. ROTT
39913	1	03-04-64	Final Proposed Design	J.P. ROTT	J.P. ROTT
39914	1	03-04-64	Final Proposed Design	J.P. ROTT	J.P. ROTT
39915	1	03-04-64	Final Proposed Design	J.P. ROTT	J.P. ROTT
39916	1	03-04-64	Final Proposed Design	J.P. ROTT	J.P. ROTT
39917	1	03-04-64	Final Proposed Design	J.P. ROTT	J.P. ROTT
39918	1	03-04-64	Final Proposed Design	J.P. ROTT	J.P. ROTT
39919	1	03-04-64	Final Proposed Design	J.P. ROTT	J.P. ROTT
39920	1	03-04-64	Final Proposed Design	J.P. ROTT	J.P. ROTT

**STATE RIVERS AND WATER SUPPLY COMMISSION**

**EPPALOCK DAM**  
**MAIN EMBANKMENT DETAILS**

DESIGNED	CHIEF	L.P. ROTT, 22-10-64	Checked	J.P. ROTT
DRAWN	TRACED	J. Rott	Checked	J. Rott
INSTRUMENTED	DATE	1-12-74	Checked	J. Rott
PROJECT	NO.	59906H	DATE	1-12-74

NOTE: Joints shown as "Painted joint" are to be treated with a min thickness of 1/8" of suitable material to prevent bonding.

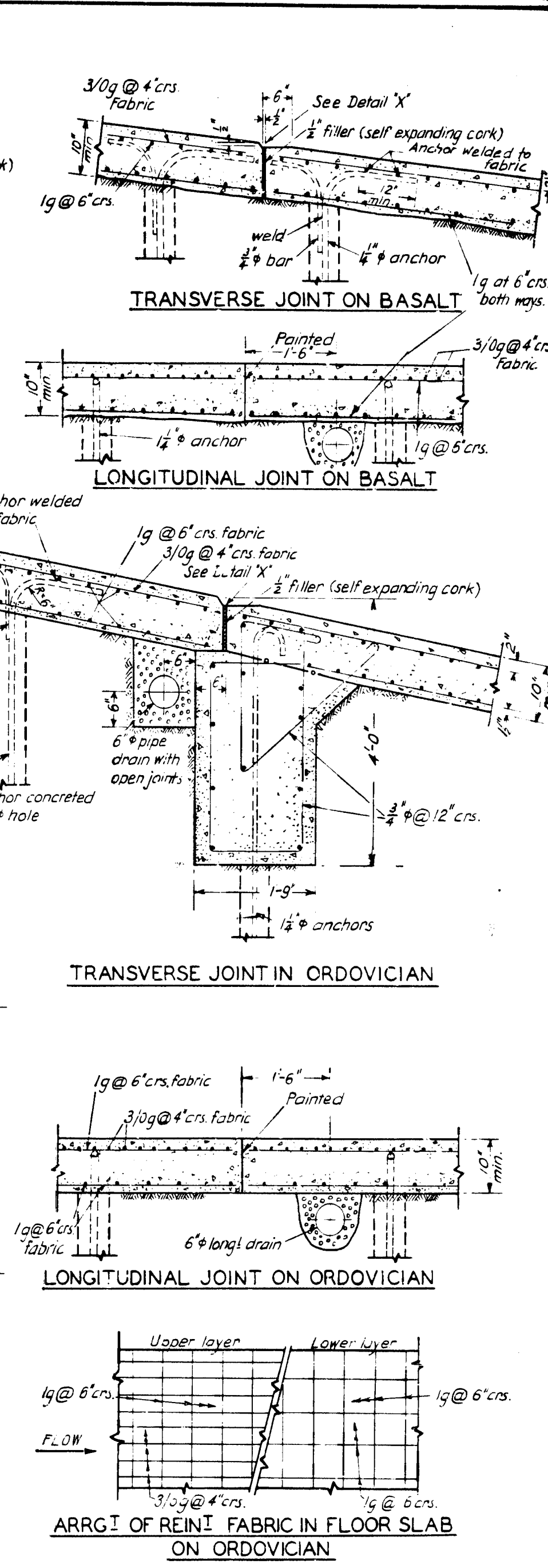
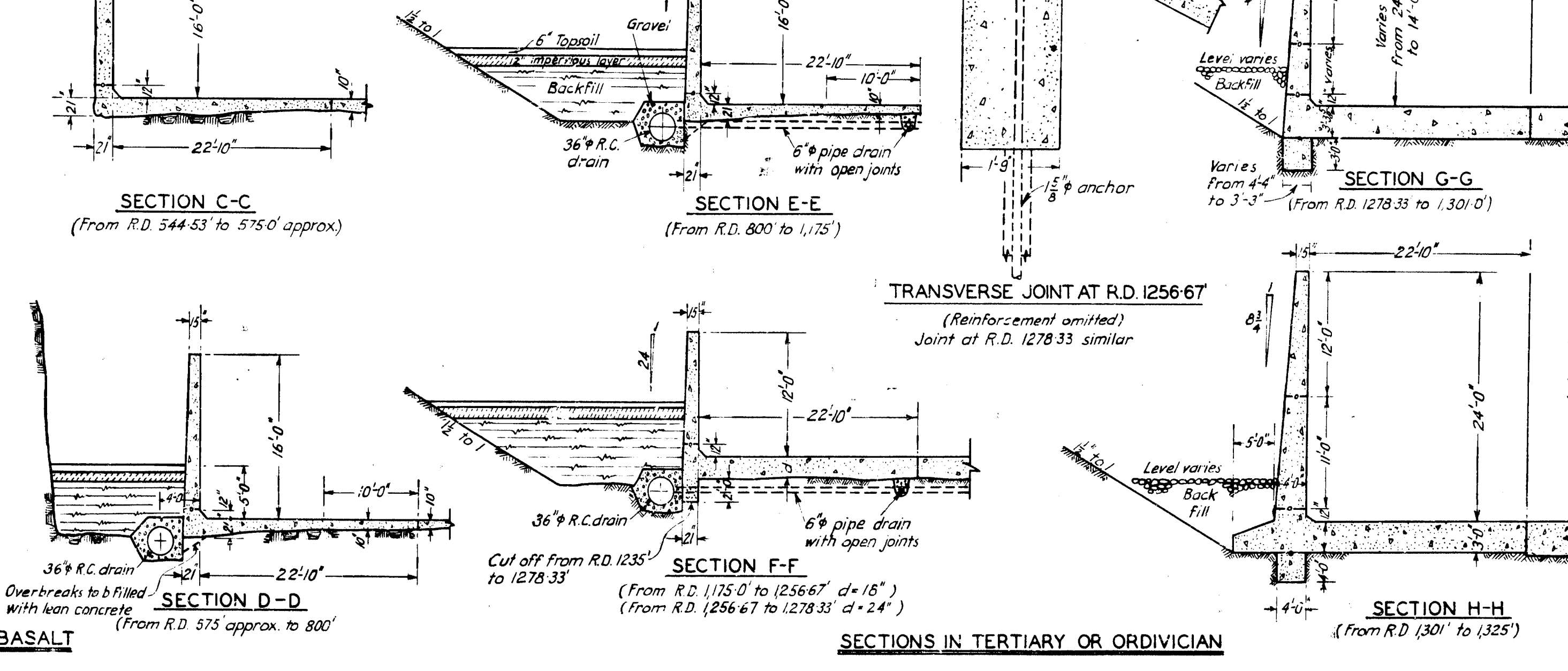
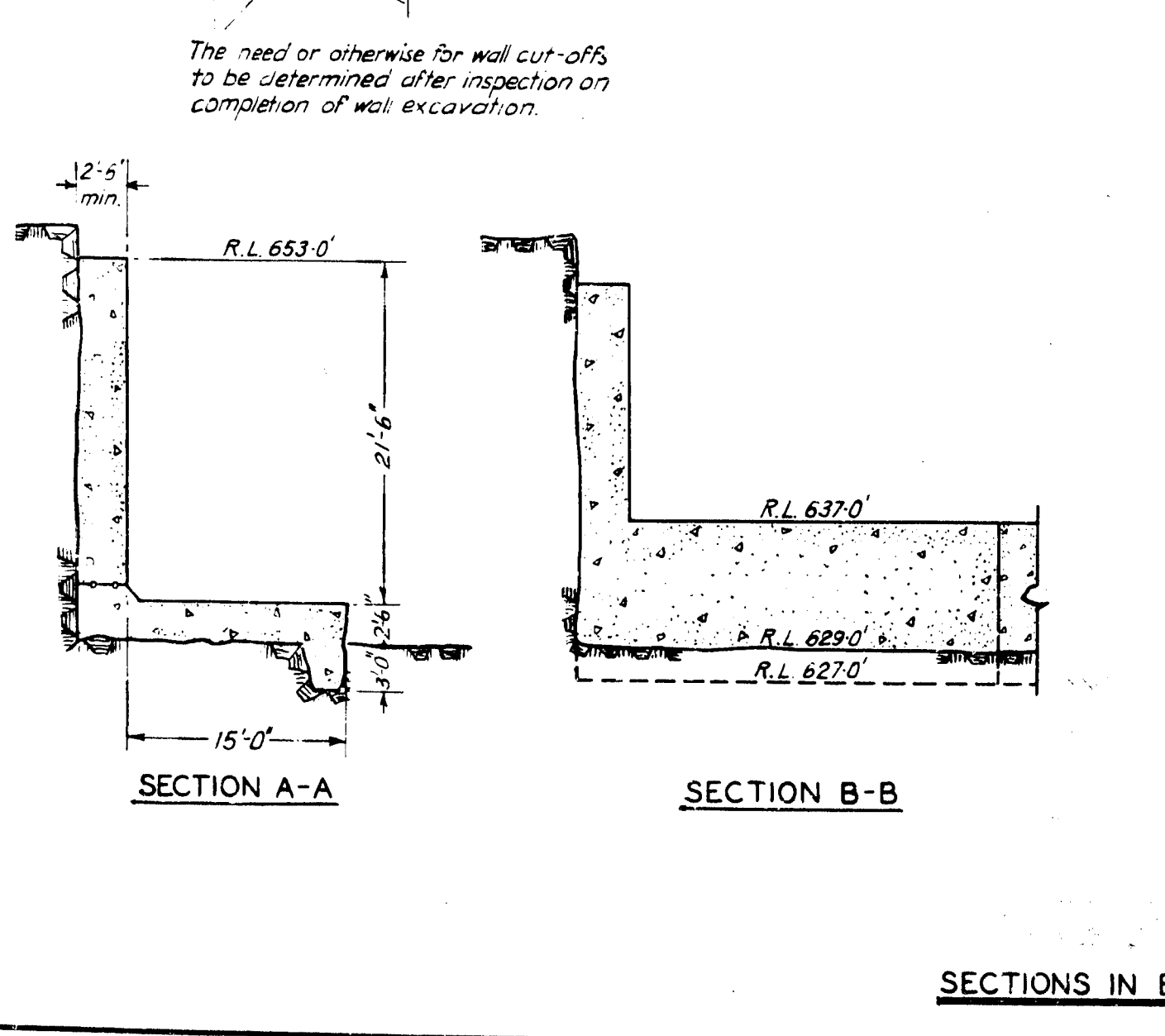
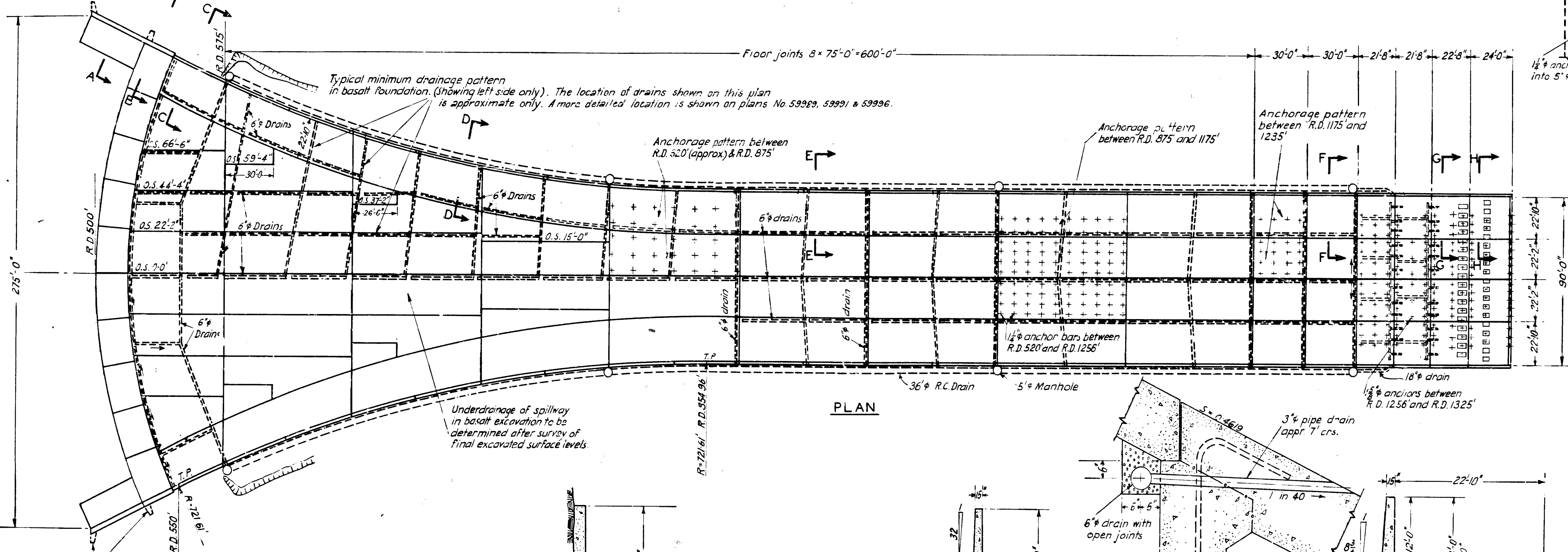
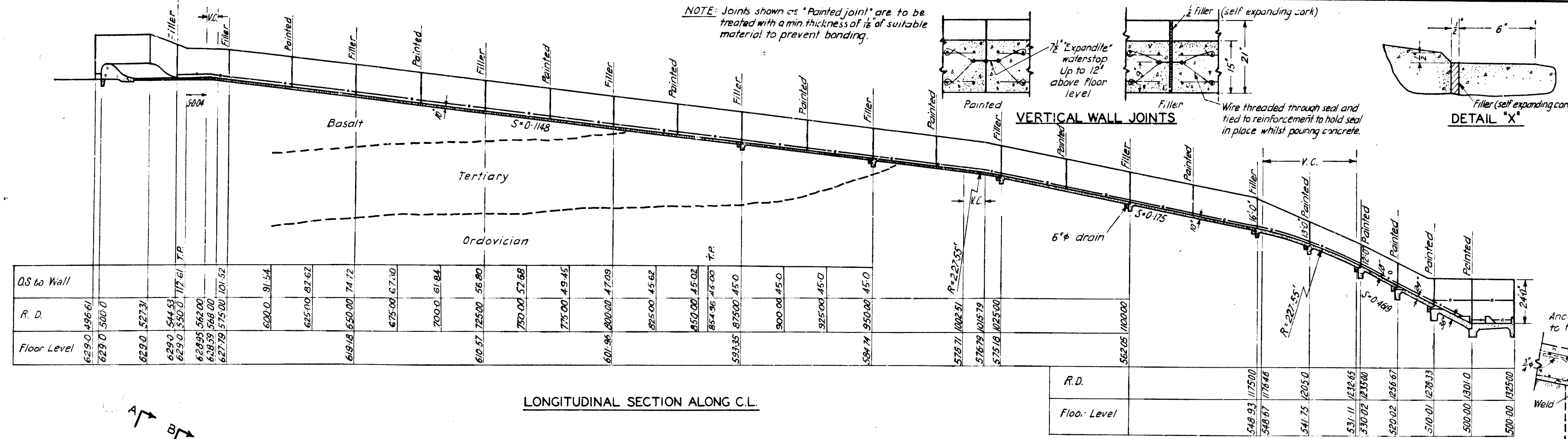

SCALES

10' 5' 0" 30' 50' Plan & Long. Section

6' 4' 8' 16' Sections A-A to H-H

2' 6' 1' 2' 3' Joint Details

REFERENCES		REVISIONS			
PLAN NO.	TITLE	NO.	DATE	DESCRIPTION	APP'D
59970	Overall concrete Details				
59989	Chute Concrete Details				
	R.D. 875 - 1175				
59997	Stilling Basin R.D. 1175 - 1278				
	Concrete Details				
78100	Stilling Basin R.D. 1278 - 1325				
	Concrete Details				
78102	Arrangement of Anchor Bars				
59991	Concrete Det. R.D. 819 - 875				

STATE RIVERS AND WATER SUPPLY COMMISSION

EPPALOCK DAM  
MAIN SPILLWAY  
ARRANGEMENT AND BASIC DETAILS

DESIGNED	7. Nicholas	SENIOR DESIGNING ENGINEER
DRAWN	A.P.C.	SENIOR DESIGNING ENGINEER
TRACED		
CHECKED		
P.E.N.		
CORR. REF.	DWG. INDEX	C-A
		78105

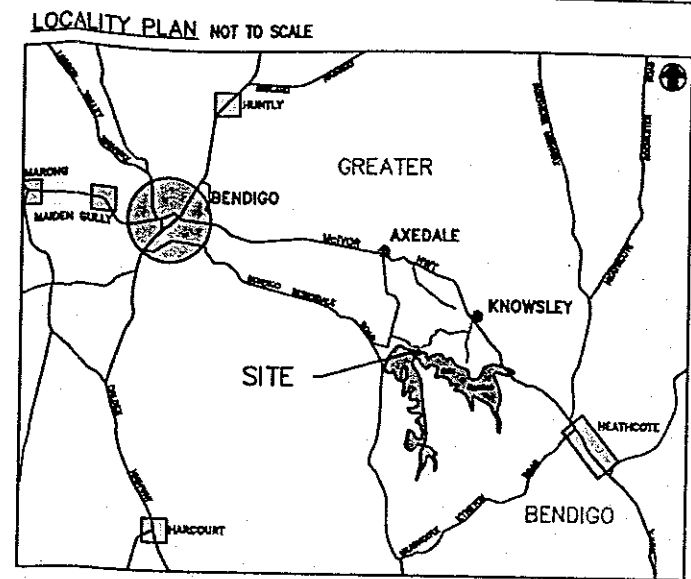
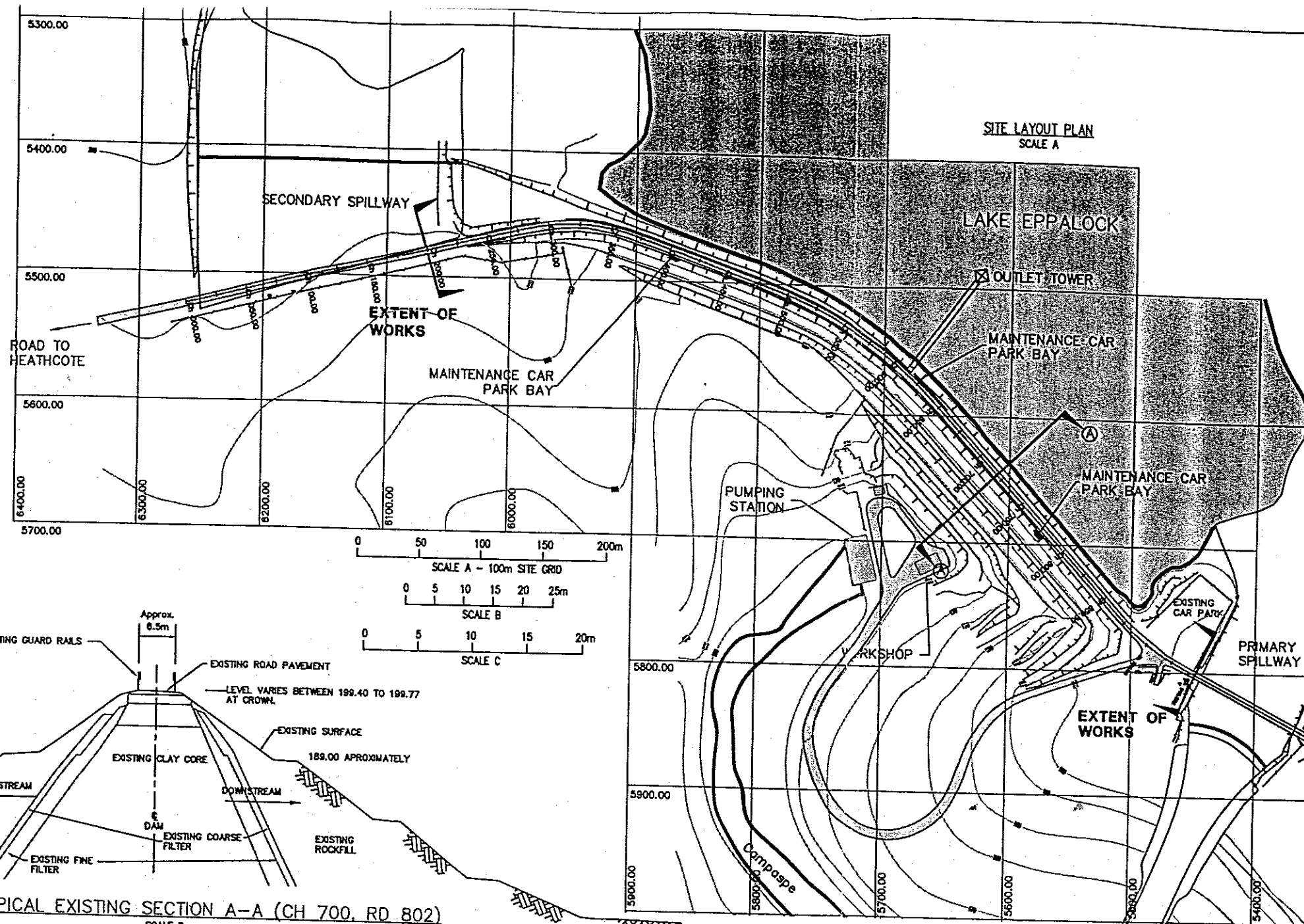

**SCOPE OF WORKS**

- The remedial works comprises
- (1) the excavation, replacement and improvement of the downstream rockfill shell, gravel filter zones and portion of the clay core above RL 189.00 m ± 0.1,
  - (2) the enlargement and improvement of the upstream rockfill shell above RL 189.00 m ± 0.1,
  - (3) minor excavation of the upstream and construction of a filter above RL 194.65 metres ± 0.1; and
  - (4) reconstruction of the crest road at RL 199.8 m to 199.95m.

Also included are works involving modification to the Outlet Tower access bridge abutment, modification to existing services including electrical, telecommunication and embankment monitoring systems and other miscellaneous works.

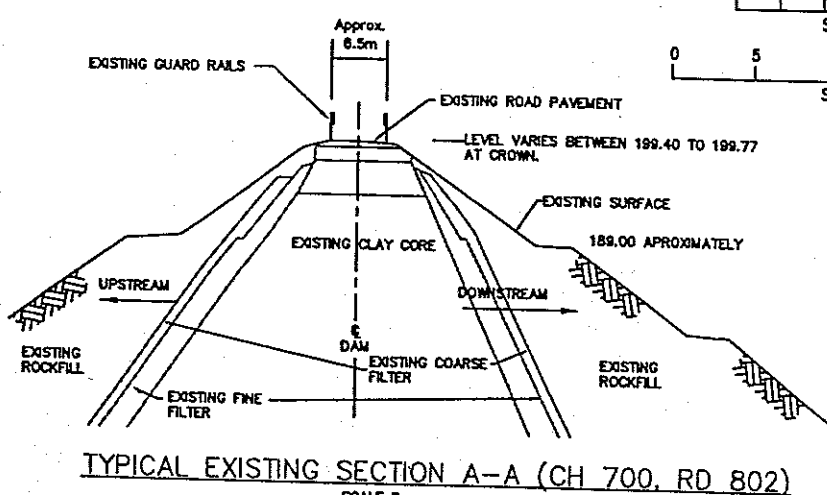

TYPICAL EXISTING SECTION A-A (CH 700, RD 802) SCALE B

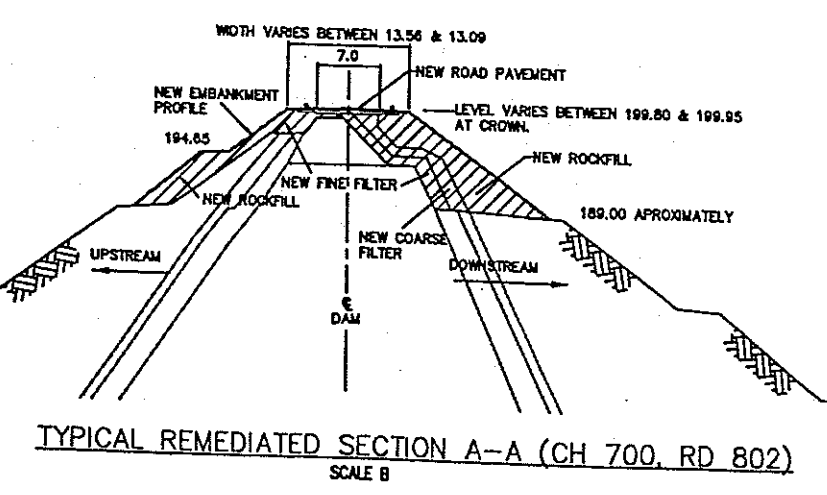

TYPICAL REMEDIATED SECTION A-A (CH 700, RD 802) SCALE B

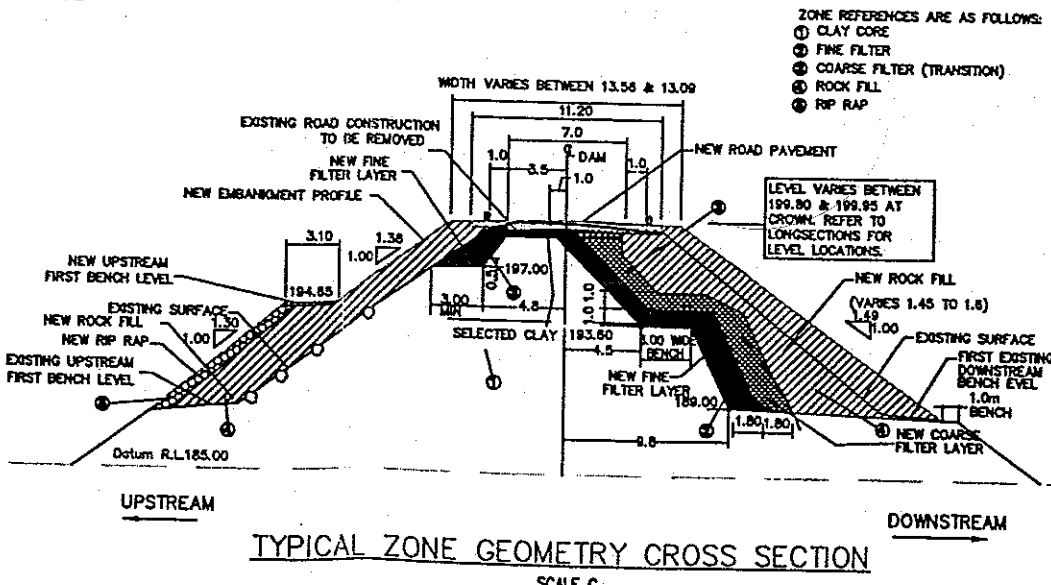

TYPICAL ZONE GEOMETRY CROSS SECTION SCALE C

**DRAWING INDEX**

This drawing index lists the full set of construction drawings for the remedial works defined in the scope of works. The drawings are to be read in conjunction with the construction specification.

NO.	GENERAL NOTES AND ABBREVIATIONS	CAD REF. DWG NO.	DRAWING TITLE	CAD REF.
48000	GENERAL ARRANGEMENT	48000	FULL CROSS SECTIONS INT 01/08	48000
48001	GENERAL NOTES AND ABBREVIATIONS	48001	SERVICE LOCATIONS	48001
48002	GENERAL NOTES AND ABBREVIATIONS	48002	CAR PARK BAY & ROAD PAVEMENT SPALL	48002
48003	GENERAL NOTES AND ABBREVIATIONS	48003	EXISTING PROFILE PROSPECTIVE VIEW	48003
48004	EXISTING CONDITIONS SURVEY PLAN SHIT 01/04	48004	NOT USED FOR CONSTRUCTION	48004
48005	EXISTING CONDITIONS SURVEY PLAN SHIT 02/04	48005	PRINTED PROFILE PROSPECTIVE VIEW	48005
48006	EXISTING CONDITIONS SURVEY PLAN SHIT 03/04	48006	OUTLET BRIDGE INSPECTION SHIT 01/08	48006
48007	PROPOSED 3000 PLAN OF EMBANKMENT SHIT 01/08	48007	PROPOSED INSTRUMENTATION LOCATIONS	48007
48008	PROPOSED 3000 PLAN OF EMBANKMENT SHIT 02/08	48008	PROPOSED INSTRUMENTATION LOCATIONS	48008
48009	PROPOSED 3000 PLAN OF EMBANKMENT SHIT 03/08	48009	CROSS SECTIONS FOR INSTRUMENT INSTALLATION	48009
48010	PROPOSED ROAD VERTICAL ALIGNMENT SHIT 01/08	48010	INSTRUMENT INSTALLATION DETAILS SHIT 01/08	48010
48011	PROPOSED ROAD VERTICAL ALIGNMENT SHIT 02/08	48011		48011
48012	PROPOSED ROAD VERTICAL ALIGNMENT SHIT 03/08	48012		48012
48013	ZONE GEOMETRY SHIT 01/08	48013		48013
48014	ZONE GEOMETRY SHIT 02/08	48014		48014
48015	ZONE GEOMETRY SHIT 03/08	48015		48015
48016	EMBANKMENT CROSS SECTIONS SHIT 01/08	48016		48016
48017	EMBANKMENT CROSS SECTIONS SHIT 02/08	48017		48017
48018	EMBANKMENT CROSS SECTIONS SHIT 03/08	48018		48018
48019	EMBANKMENT CROSS SECTIONS SHIT 01/08	48019		48019
48020	EMBANKMENT CROSS SECTIONS SHIT 02/08	48020		48020
48021	EMBANKMENT CROSS SECTIONS SHIT 03/08	48021		48021
48022	EMBANKMENT CROSS SECTIONS SHIT 01/08	48022		48022
48023	EMBANKMENT CROSS SECTIONS SHIT 02/08	48023		48023
48024	EMBANKMENT CROSS SECTIONS SHIT 03/08	48024		48024
48025	EMBANKMENT CROSS SECTIONS SHIT 01/08	48025		48025
48026	EMBANKMENT CROSS SECTIONS SHIT 02/08	48026		48026
48027	EMBANKMENT CROSS SECTIONS SHIT 03/08	48027		48027
48028	EMBANKMENT CROSS SECTIONS SHIT 01/08	48028		48028
48029	EMBANKMENT CROSS SECTIONS SHIT 02/08	48029		48029
48030	EMBANKMENT CROSS SECTIONS SHIT 03/08	48030		48030

REV	DATE	DESIGN	REVD	APPD	FOR REVIEW	REVISIONS	REV.	PLAN NO.	REFERENCE PLAN TITLE
3	02/03/08					ISSUED FOR CONSTRUCTION			
2	15/1/08					AMENDMENT TWO - ISSUED FOR CONSTRUCTION			
1	23/12/07					AMENDMENT ONE			
0	07/12/07								

COPYRIGHT  
Copyright of this drawing vests in Goulburn-Murray Water

**Woodward Clyde** WATER

Goulburn - Murray Water Authority  
40 CHASEY STREET (PO BOX 195), TULLAH VIC. 3618

00010180

01 01

00010180

01 01

00010180

01 01

**FOR CONSTRUCTION**

**LAKE EPPALOCK MAIN EMBANKMENT REMEDIAL WORKS**

**GENERAL ARRANGEMENT**

DWG	CORR. NO.	NO.	DATE	BY	FOR	REVISION
00010180	01	01				



## Appendix B Options not assessed in detail

### Options assessed at the workshop held on June 7<sup>th</sup> 2023

#### B.1 Using filling curves

After the January 2011 floods in northern Victoria, GWM commissioned SKM to investigate whether the adoption of filling curves at Lake Eppalock would potentially increase the flood mitigation provided by the storage. Adopting a filling curve would involve using the downstream outlet to control the reservoir level – to the degree possible – to follow a defined storage trace rather than allowing the storage to fill at the earliest opportunity.

SKM (2012a) found that using a filling curve at Lake Eppalock was likely to make a marginal difference to flood frequencies downstream of the storage. Additionally, the 2011 flood would have been unaffected by a filling curve, given it occurred in January. Based on these findings, it was decided not to revisit the use of filling curves as a potential operating option for increasing the flood mitigation provided by Lake Eppalock.

Element	Subjective Rating
Potential to reduce peak outflow from Eppalock	Low
Reduced reliability of supply	Low – Medium
Constructability	N/A
Capital cost of works	Low
Operational risk	Low
Environmental impact	Low
Recreational impact	Low

#### B.2 Increasing outlet capacity, while maintaining existing FSL

The option to increase outlet capacity, but without reducing the FSL or target storage at Lake Eppalock, was not assessed in detail because it is unlikely to significantly increase the flood mitigation provided by Lake Eppalock. This is because of the uncertainties associated with rainfall and streamflow forecasts for the Campaspe River catchment. These uncertainties – which are discussed in Section 6.3 and Section 7.2.2 – mean that there will rarely be situations when there is enough lead-time before floods to pre-release significant volumes through a larger outlet, without risking the loss of water stored by entitlement holders or exacerbating downstream flooding.

Element	Subjective Rating
Potential to reduce peak outflow from Eppalock	Low – Medium
Reduced reliability of supply	Low – Medium
Constructability	Difficult
Capital cost of works	High
Operational risk	Medium (when used for flood pre-releases)
Environmental impact	Low
Recreational impact	Low





### B.3 Adding spillway gates, and reducing FSL

An option to reduce the Lake Eppalock FSL and add gates to the primary spillway was considered in the early stages of this study. Lowering FSL when adding spillway gates would reduce or remove the need to raise the primary and secondary embankments, and hence reduce the initial capital cost. However, the assessment of the volume of water that would need to be recovered from the Campaspe system (Section 8.2) and consideration of the upstream impacts (Section 9.1) demonstrated that any saving from avoiding or minimising embankment upgrades would be partially or wholly offset by the costs of compensating parties affected by the reduction of FSL.

Element	Subjective Rating
Potential to reduce peak outflow from Eppalock	High
Reduced reliability of supply	High
Constructability	Difficult
Capital cost of works	High
Operational risk	High
Environmental impact	Low – Medium
Recreational impact	Medium

#### Options considered during later stages of the technical assessment

### B.4 Transferring water to Greens Lake or Lake Cooper

The transferring of water to Greens Lake and / or Lake Cooper has been raised by some Rochester residents as a potential option for increasing the airspace in Lake Eppalock. However, this option was not assessed in detail for three reasons.

Firstly, Lake Eppalock is in the Campaspe River catchment but Greens Lake and Lake Cooper are in the Goulburn River catchment. Moving water across the divide between the two catchments would require significant infrastructure. For example, the Bendigo component of the Goldfields superpipe, which draws water from the Western Waranga Channel in the Goulburn River catchment and supplies it to Lake Eppalock cost \$66 million to build when completed in 2007<sup>41</sup>.

Secondly, the volume of water that could have been stored in Greens Lake and Lake Cooper during the 2011 and 2022 floods was small compared with the airspace that would have been required at Lake Eppalock to make a significant difference to the peak outflows during those events. Figure 67 shows that Greens Lake and Lake Cooper were near or above capacity<sup>42</sup> in January / February 2011 *without* any transfers from Lake Eppalock, and in 2022 there was approximately 5,700 ML of capacity at Greens Lake. 5,700 ML is a fraction of the inflows experienced at Lake Eppalock during the 2022 flood (Section 7).

<sup>41</sup> <https://www.audit.vic.gov.au/sites/default/files/20080528-Goldfields-Pipeline-Summary.pdf>

<sup>42</sup> Capacities provided by GMW: 32,500 ML at Greens Lake and 27,000 ML at Lake Cooper

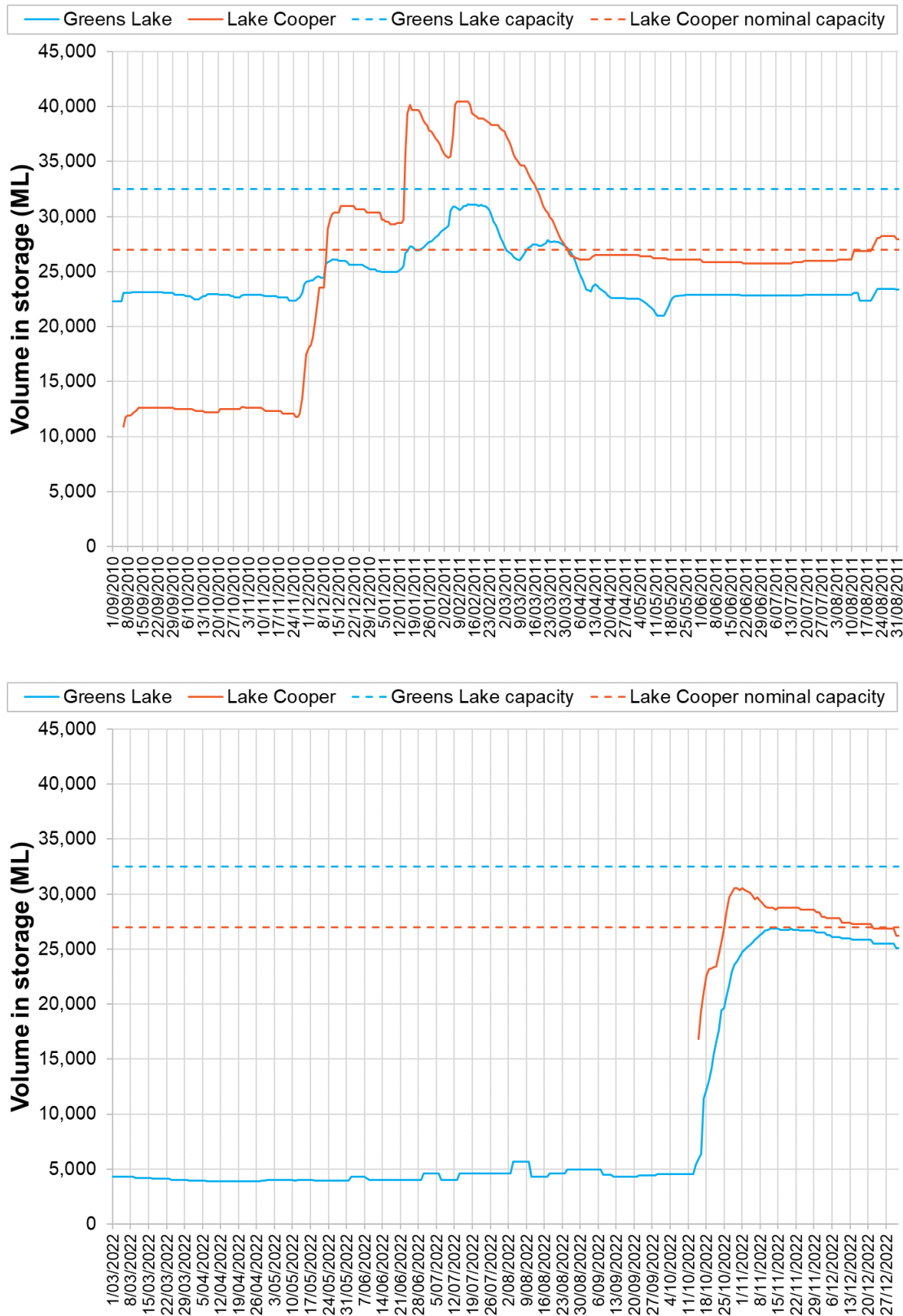

Figure 67: Historic storage traces for Greens Lake and Lake Cooper during 2011 (top) and 2022 (bottom)



Thirdly, Greens Lake and Lake Cooper are terminal lakes. This means that there is no natural outlet for water in these lakes. In addition, infrastructure for pumping water from the lakes to the irrigation distribution system was decommissioned in 2019 as part of the Connections Project<sup>43</sup>. This means that any water transferred to Greens Lake or Lake Cooper would not be available for downstream use, and would be treated as a 'diversion' to be accounted against the Sustainable Diversion Limit for Northern Victoria<sup>44</sup>.

### B.5 Syphons

During Milestone 1 of this study, the use of syphons to move water from the Lake Eppalock reservoir to downstream of the spillway was raised as a potential option for increasing air space, and hence flood mitigation provided by the storage. This option was not assessed in detail because syphons are typically a temporary rather than permanent pathway for releasing water from storage, and are generally not designed with the capability to vary release rates or withstand flood conditions. Therefore, use of syphons was not considered a reasonable substitute or addition to the option of increasing the outlet capacity at Lake Eppalock (Section 8.1.1).

### B.6 Varying target storage by climate condition

As part of the work done for Milestone 1, a target storage that varied with climate conditions was trialled. However, the trial demonstrated that varying target storage by antecedent rainfall or soil moisture conditions did not materially change the modelled Lake Eppalock storage trace (Figure 68) – and hence the downstream flood risks – or allocations to water entitlement holders. Therefore, this option was not assessed in more detail during Milestone 2.

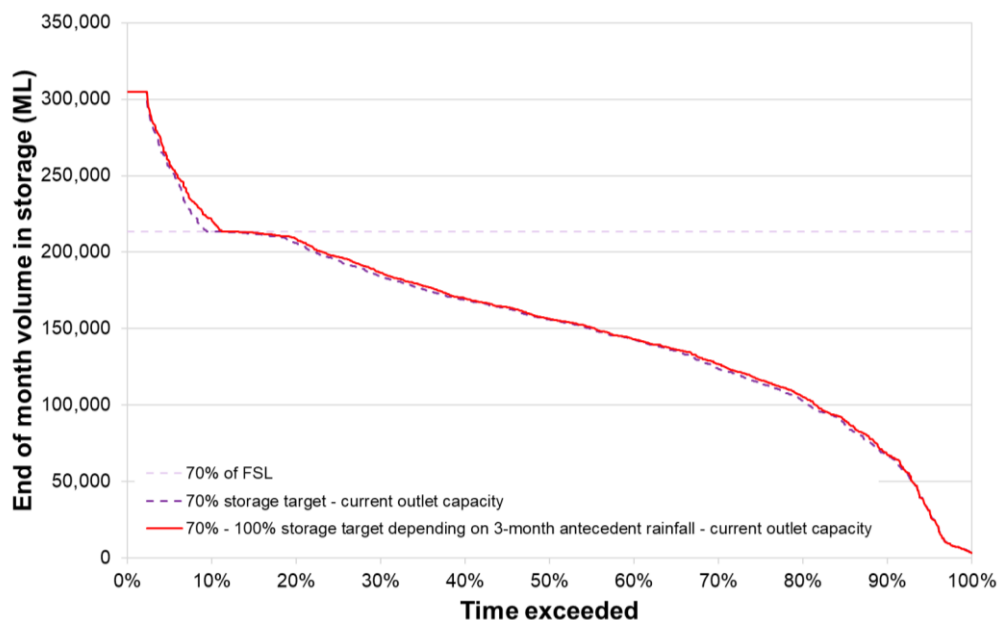

Figure 68: Initial testing of an option where the target storage varies based on climate condition

<sup>43</sup> <https://www.g-mwater.com.au/customer-services-resources/projects/connectionsproject>

<sup>44</sup> <https://www.water.vic.gov.au/our-programs/murray-darling-basin/water-resource-plans>



## Appendix C Concept design drawings

**Option:  
Increased  
outlet  
capacity**

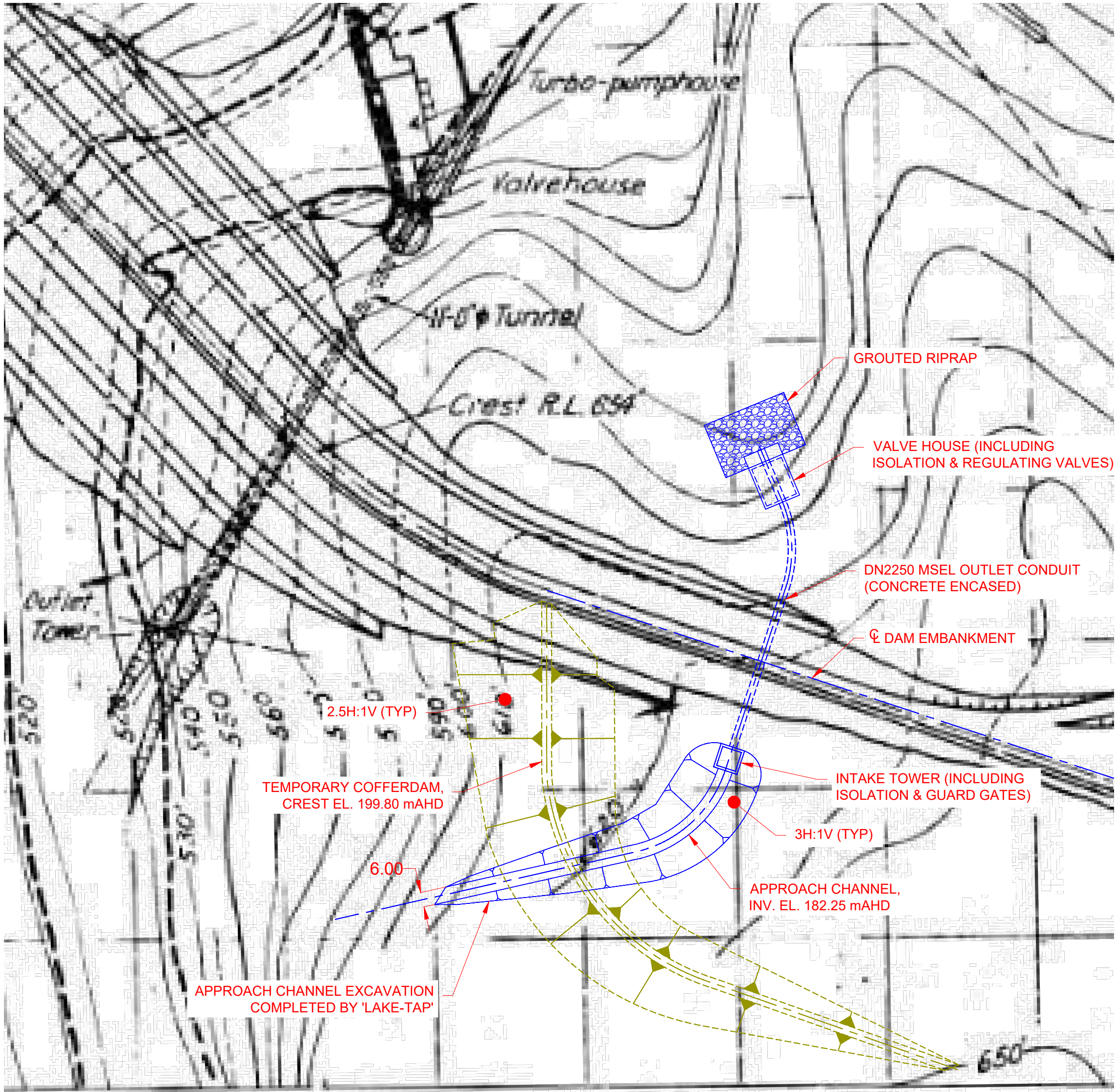

# Option: Increased outlet capacity

Side view

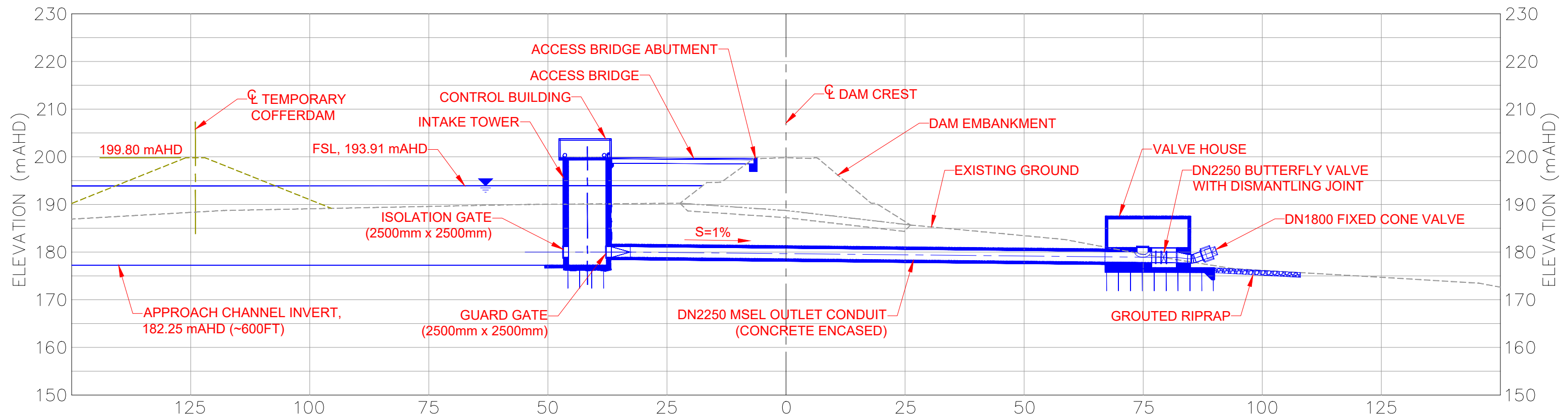

**Option: Increased outlet capacity**  
*Cross-section of outlet tunnel*

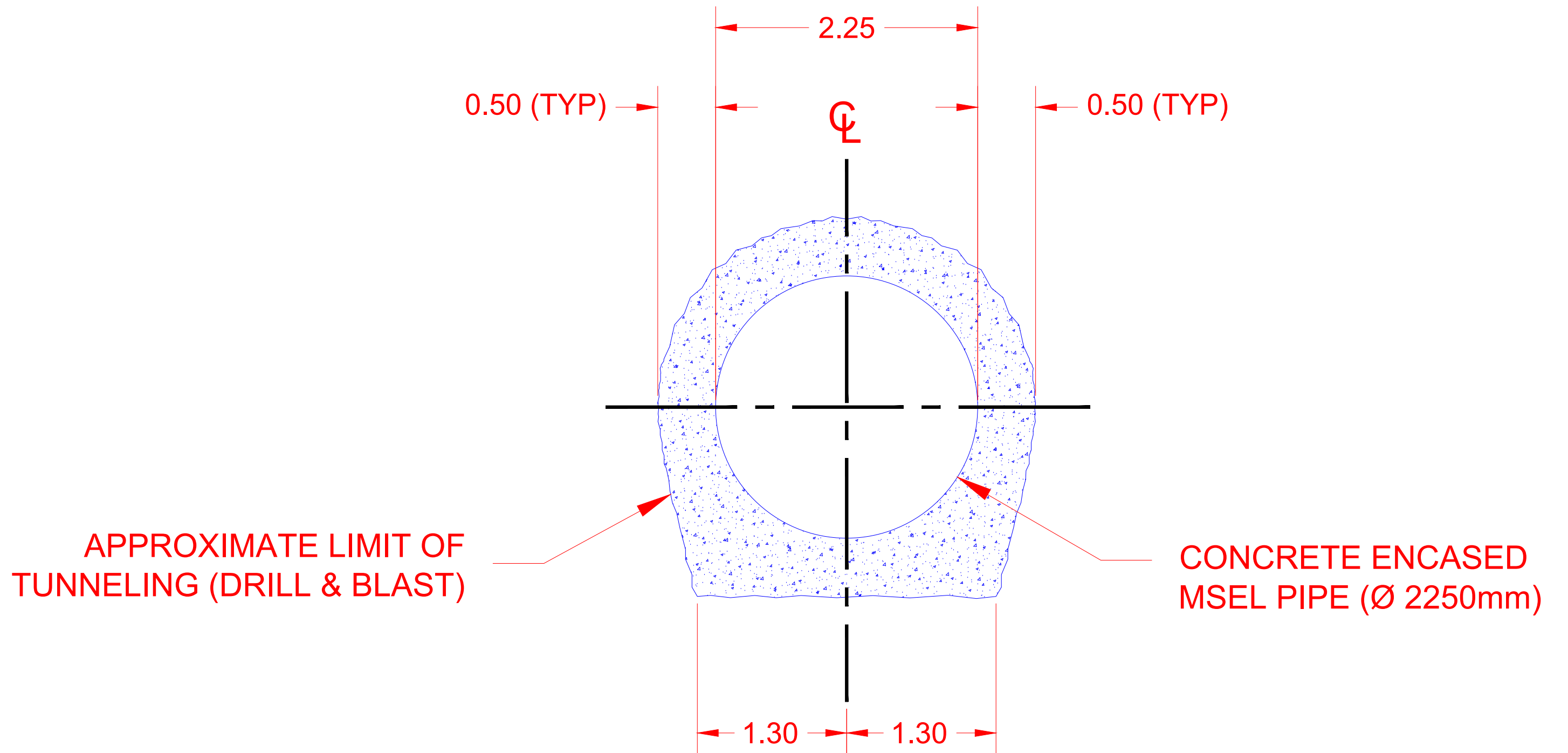

# Option: Spillway slot Plan view

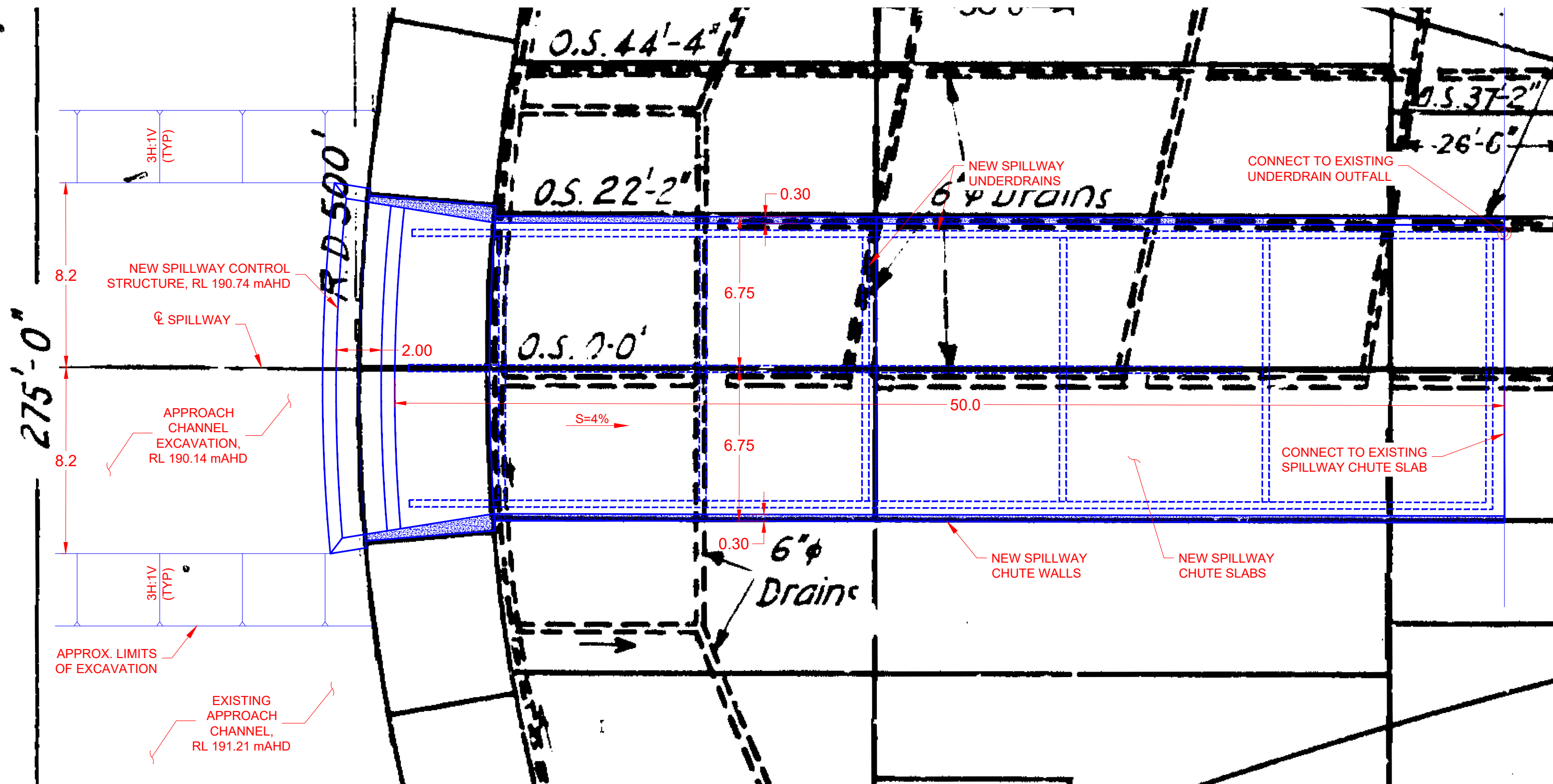



# Option: Spillway slot

Side view

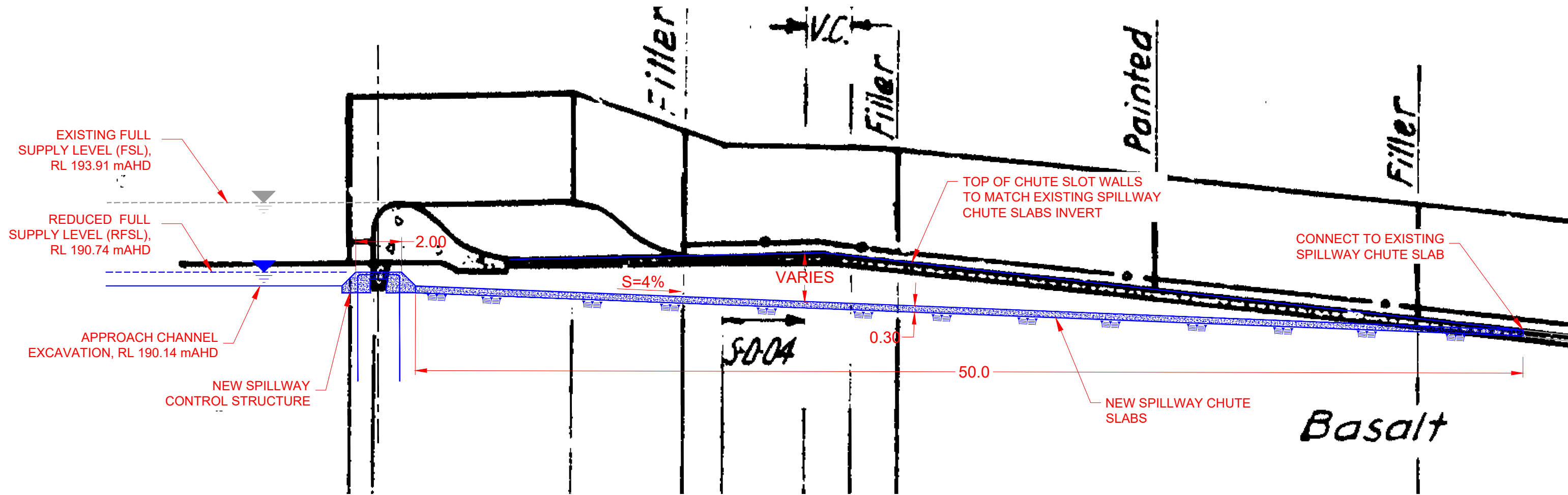

# Option: Spillway slot

Side view

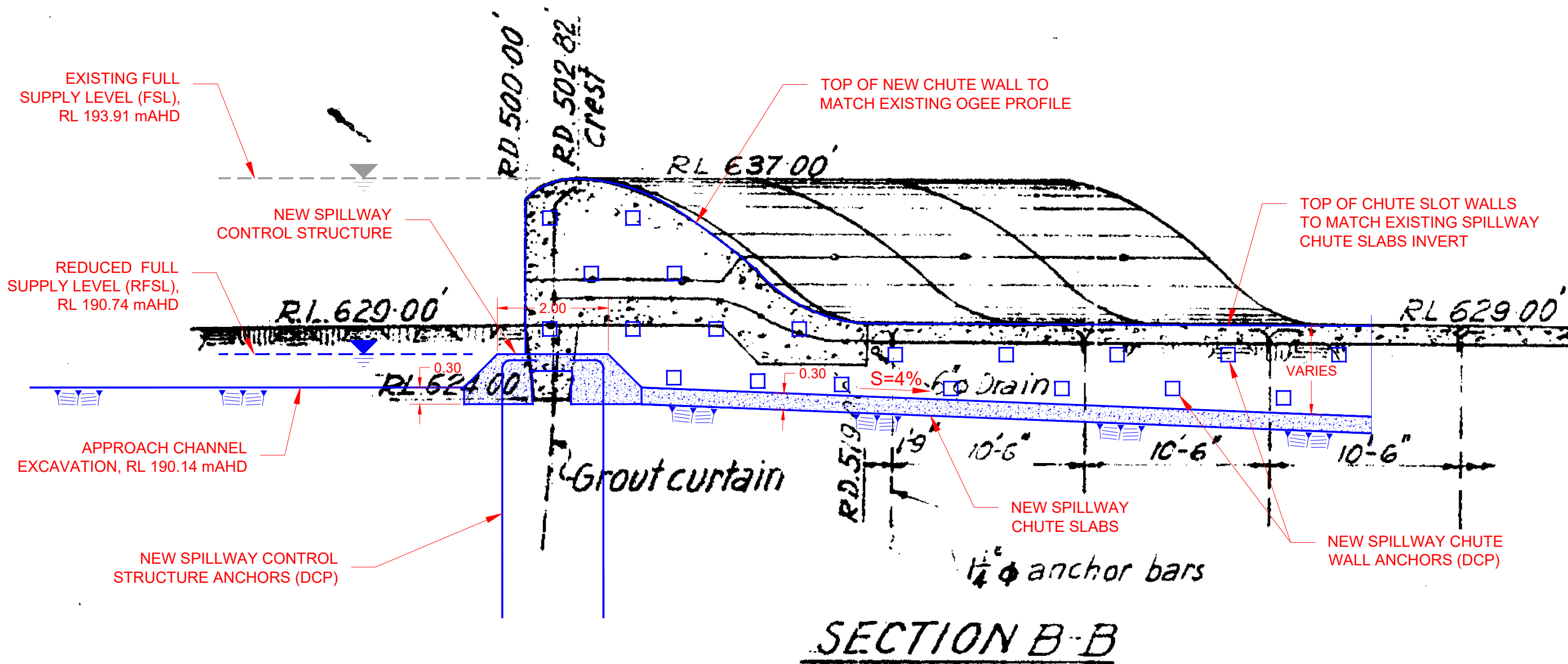

# Option: Spillway slot

*Cross-section view*

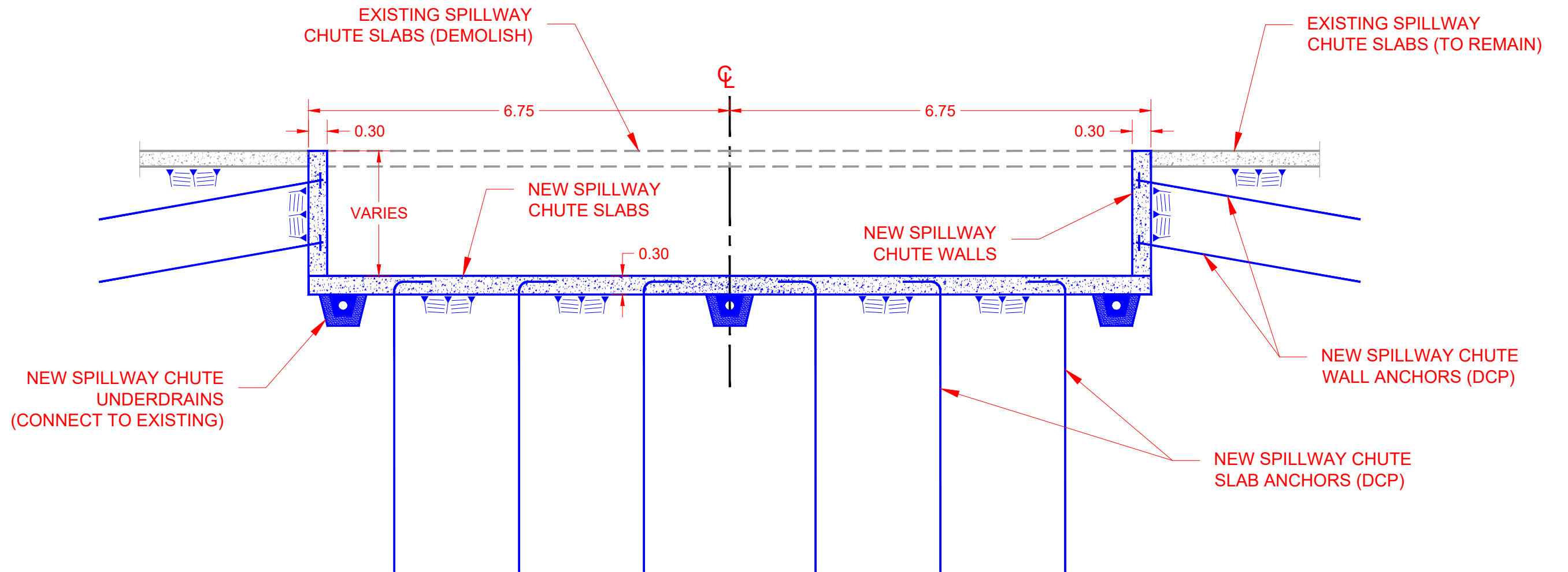

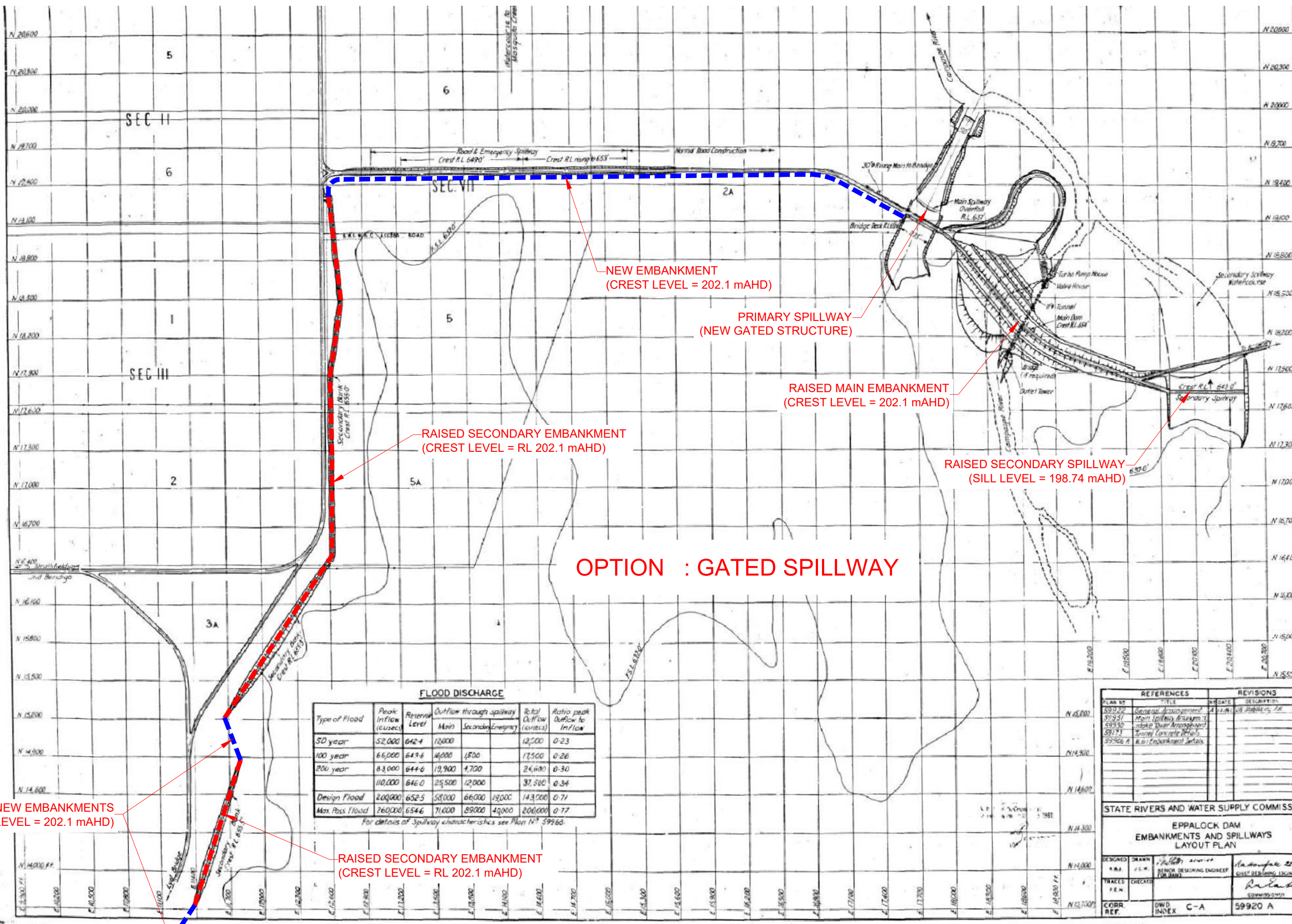

**OPTION : GATED SPILLWAY**

**NEW EMBANKMENTS  
(CREST LEVEL = 202.1 mAHD)**

**NEW EMBANKMENT  
(CREST LEVEL = 202.1 mAHD)**

**PRIMARY SPILLWAY  
(NEW GATED STRUCTURE)**

**RAISED MAIN EMBANKMENT  
(CREST LEVEL = 202.1 mAHD)**

**RAISED SECONDARY EMBANKMENT  
(CREST LEVEL = RL 202.1 mAHD)**

**RAISED SECONDARY SPILLWAY  
(SILL LEVEL = 198.74 mAHD)**

**RAISED SECONDARY EMBANKMENT  
(CREST LEVEL = RL 202.1 mAHD)**

**FLOOD DISCHARGE**

Type of Flood	Peak Inflow (cusecs)	Reserve Level	Outflow through spillway			Total Outflow (cusecs)	Ratio peak Outflow to Inflow
			Main	Secondary	Emergency		
50 year	52,000	642.4	12,000		12,000	0.23	
100 year	66,000	643.6	16,000	1,500	17,500	0.26	
200 year	83,000	644.6	19,900	1,700	21,600	0.30	
Design Flood	110,000	646.0	25,500	12,000	37,500	0.34	
Max. Poss. Flood	260,000	654.6	71,000	89,000	160,000	0.77	

For details of Spillway characteristics see Plan N° 5996B.

REFERENCES		REVISIONS	
PLAN NO	TITLE	NO DATE	DESCRIPTION
5992A	General Arrangement	A	18/11/58
5995A	Main Spillway Arrangement	B	18/11/58
5993A	Outlet Tower Arrangement	C	18/11/58
5997A	Outlet Tower Details	D	18/11/58
5996A	Spillway Embankment Details	E	18/11/58

**STATE RIVERS AND WATER SUPPLY COMMISSION**

**EPPALOCK DAM  
EMBANKMENTS AND SPILLWAYS  
LAYOUT PLAN**

DESIGNED R.B.	DRAWN C.W.	CHECKED R.B.	APPROVED R.B.
SENIOR DESIGNING ENGINEER		CHIEF DESIGNING ENGINEER	
CORR. REF.		INDEX	C-A
		5992A	

**Option: Add spillway gates**  
*Plan view of primary spillway*

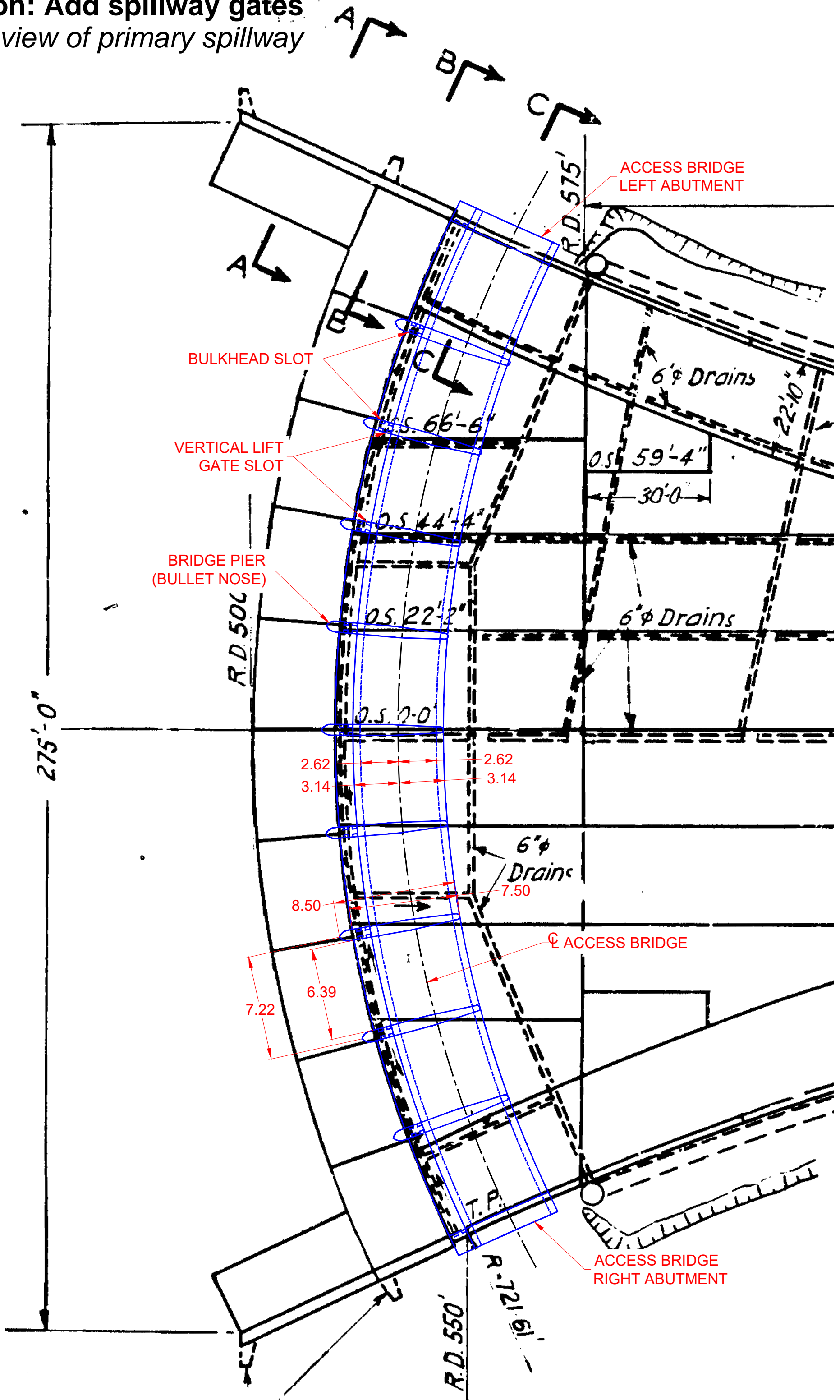

# Option: Add spillway gates

## Side view of primary spillway

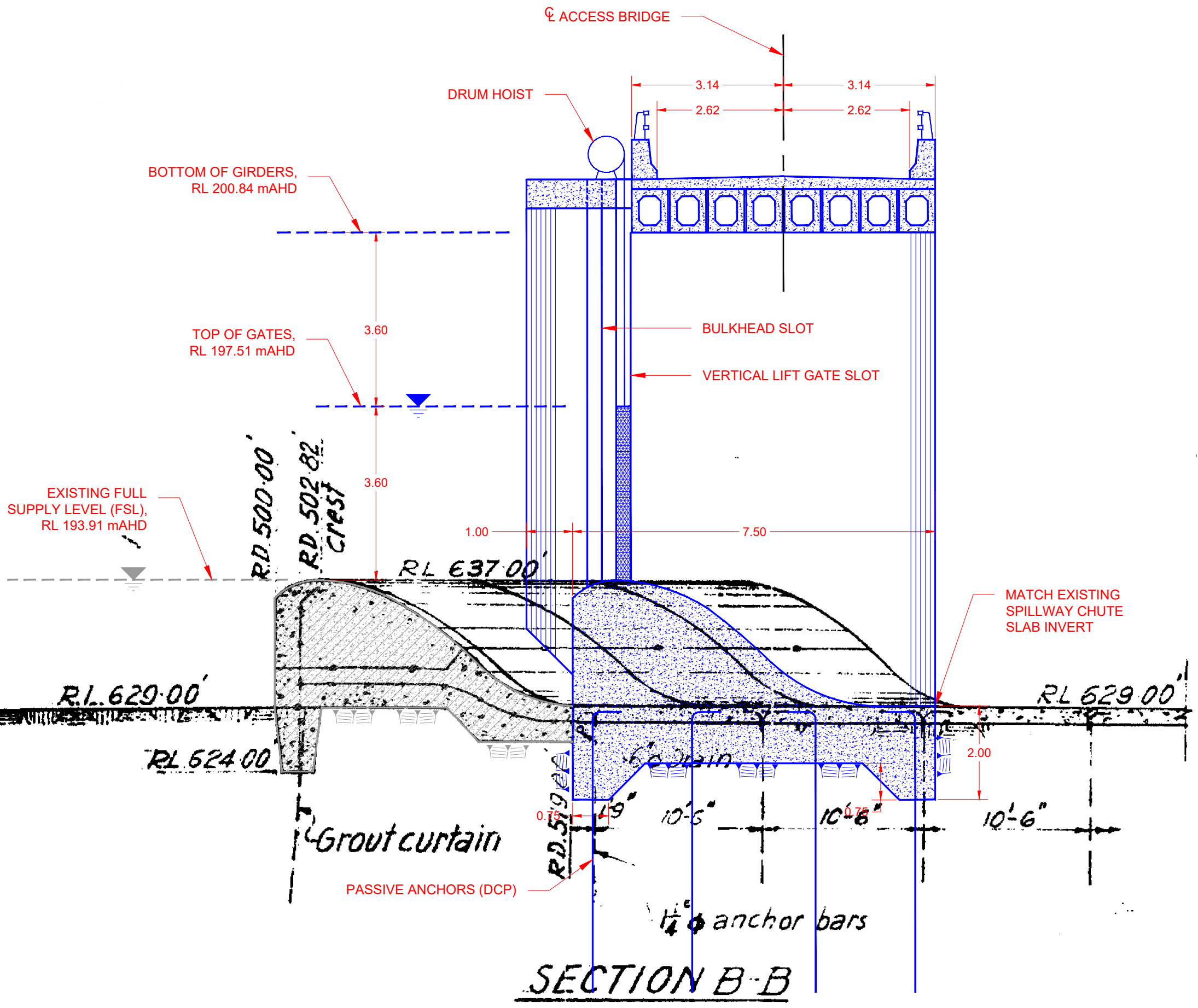

# Option: Add spillway gates

## Plan view of raised secondary spillway

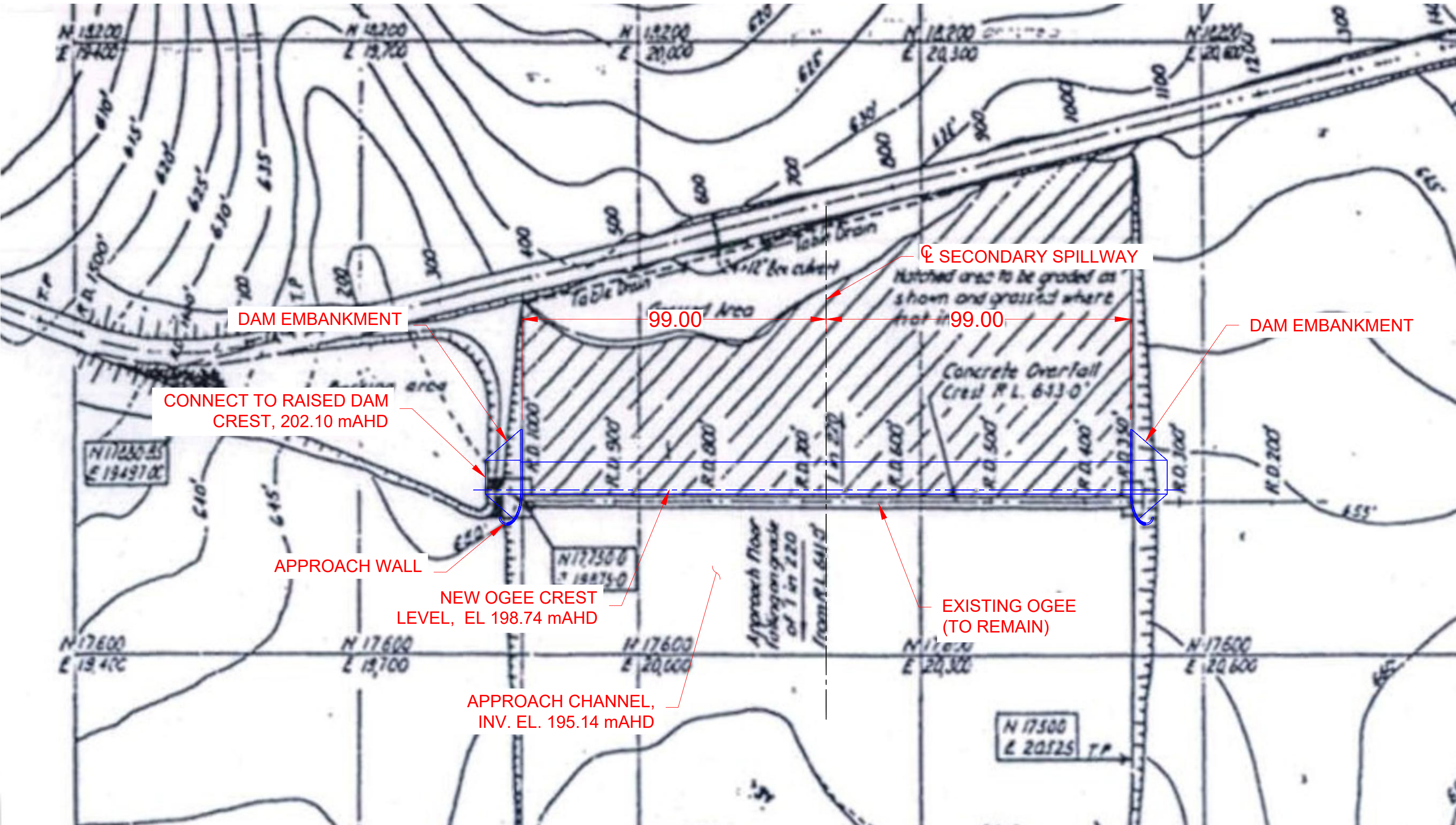

# Option: Add spillway gates

## Side view of raised secondary spillway

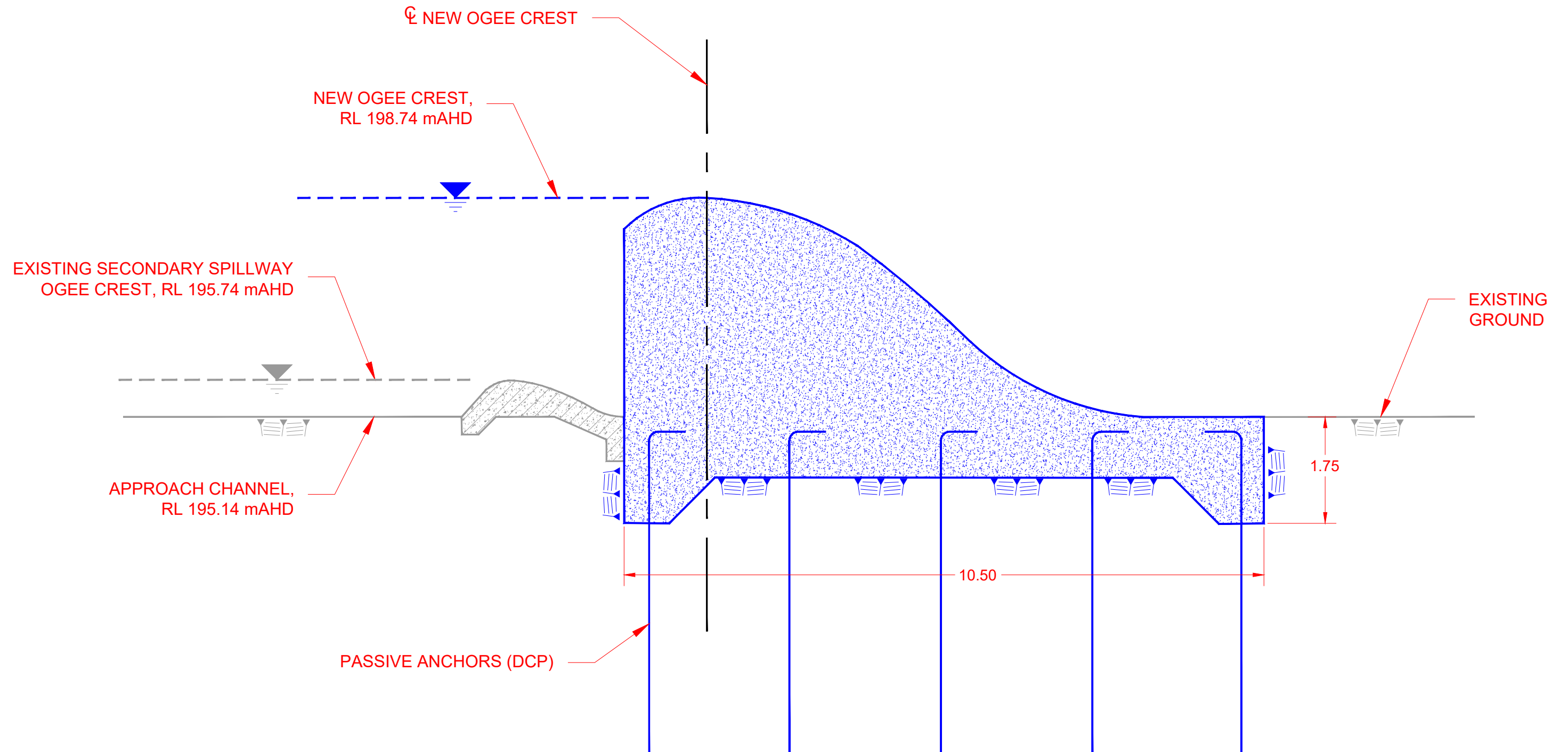



# Option: Add spillway gates

## Typical sections for embankment works

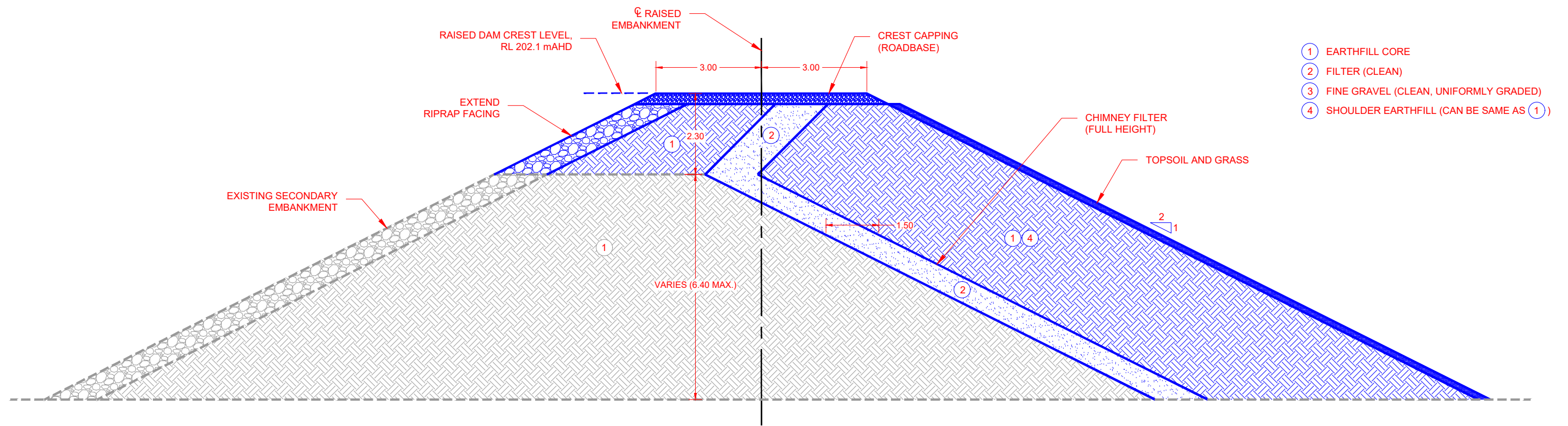

**RAISED SECONDARY EMBANKMENT  
TYPICAL SECTION**

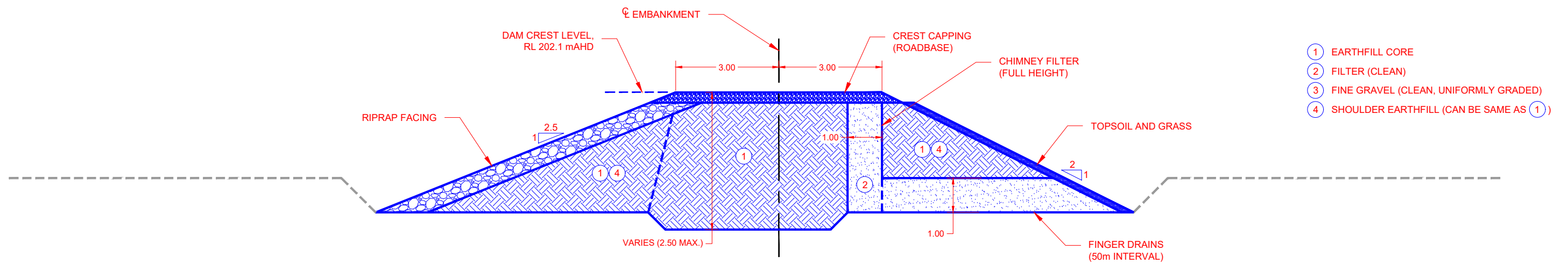

**NEW SECONDARY EMBANKMENT  
TYPICAL SECTION**

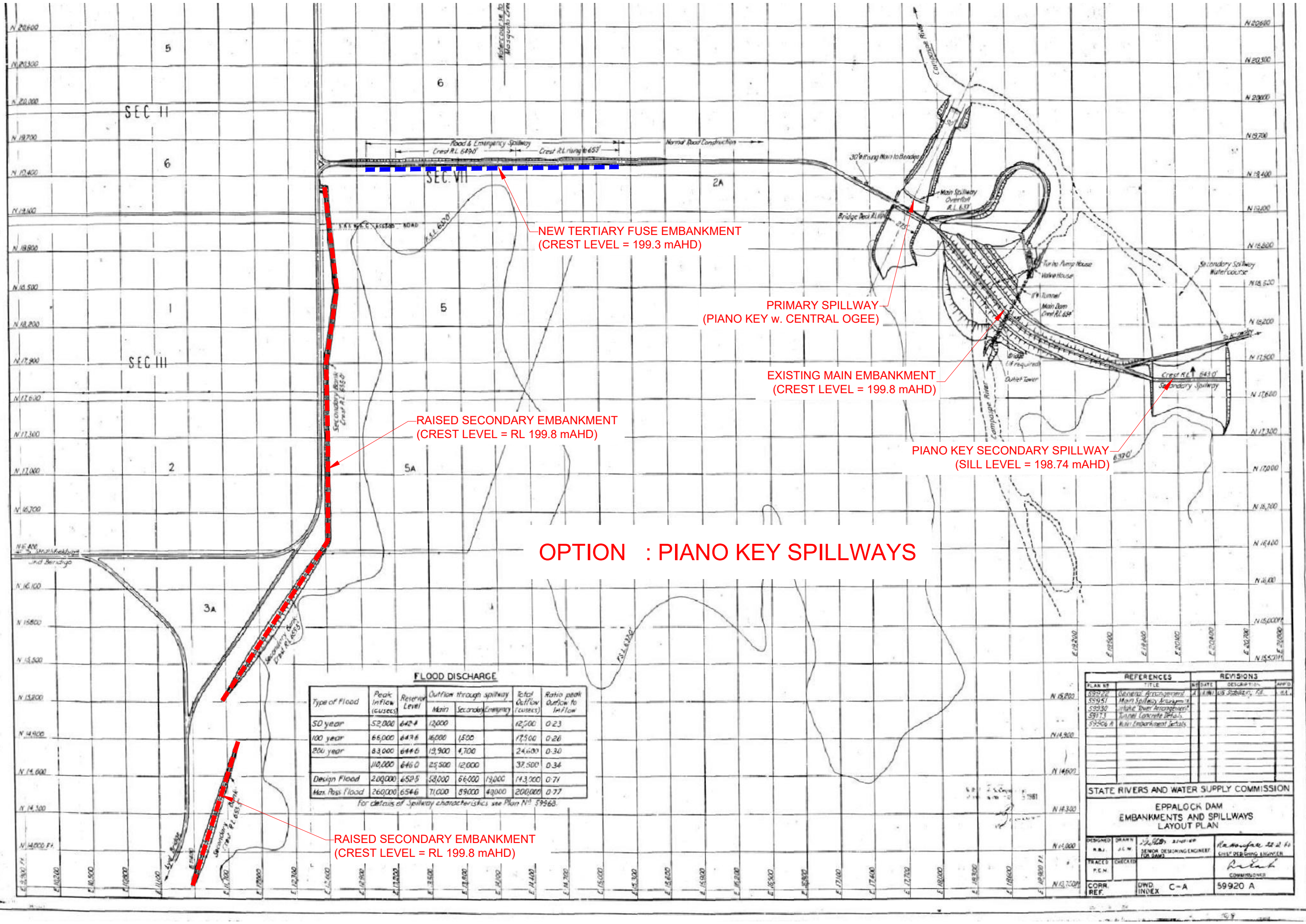

**OPTION : PIANO KEY SPILLWAYS**

**FLOOD DISCHARGE**

Type of Flood	Peak Inflow (cusecs)	Reversal Level	Outflow through spillway			Total Outflow (cusecs)	Ratio peak Outflow to Inflow
			Main	Secondary	Emergency		
50 year	52,000	642.4	12,000		12,000	0.23	
100 year	66,000	647.6	16,000	1,500	17,500	0.26	
200 year	83,000	644.6	19,900	4,700	24,600	0.30	
	110,000	646.0	25,900	12,000	37,900	0.34	
Design Flood	200,000	652.5	58,000	66,000	124,000	0.71	
Max. Poss Flood	260,000	654.6	71,000	89,000	160,000	0.77	

*For details of Spillway characteristics see Plan No 5996B.*

REFERENCES		REVISIONS	
PLAN NO	TITLE	DATE	DESCRIPTION
5992A	General Arrangement	1/1/58	US 3000, 70'
5995	Main Spillway Arrangement		
5993	Inflow River Arrangement		
5917	Tunnel Concrete Details		
5926A	Main Embankment Details		

**STATE RIVERS AND WATER SUPPLY COMMISSION**

**EPPALOCK DAM  
EMBANKMENTS AND SPILLWAYS  
LAYOUT PLAN**

DESIGNED	DRN	1/1/58	1/1/58
BY	JCW	SENIOR DESIGNING ENGINEER	SENIOR DESIGNING ENGINEER
TRACES	CHECKED		
PCN			
CORR. REF.	DWD INDEX	C-A	59920 A

# Option: Piano key spillways

Plan view of primary spillway

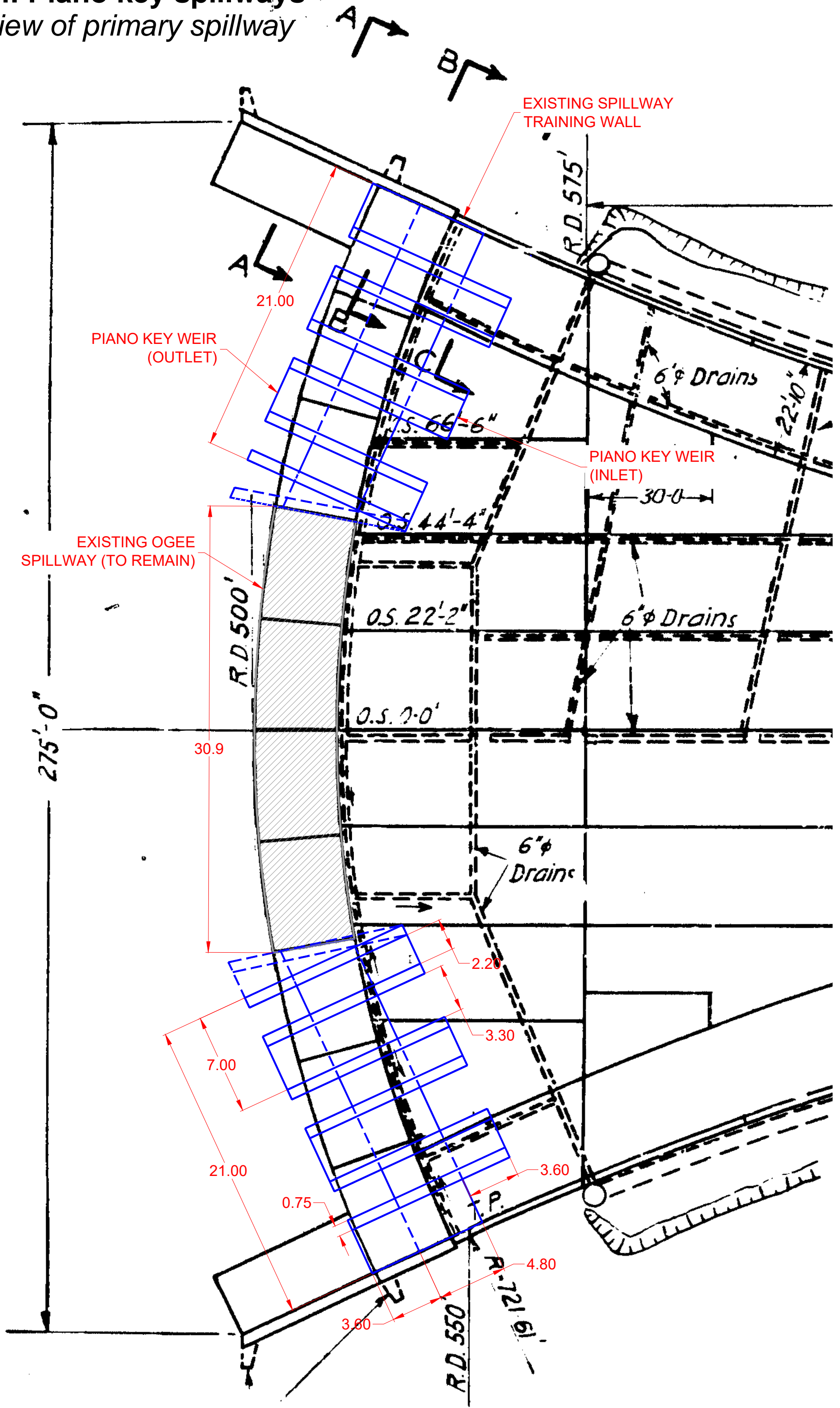

# Option: Piano key spillways

## Side view of primary spillway

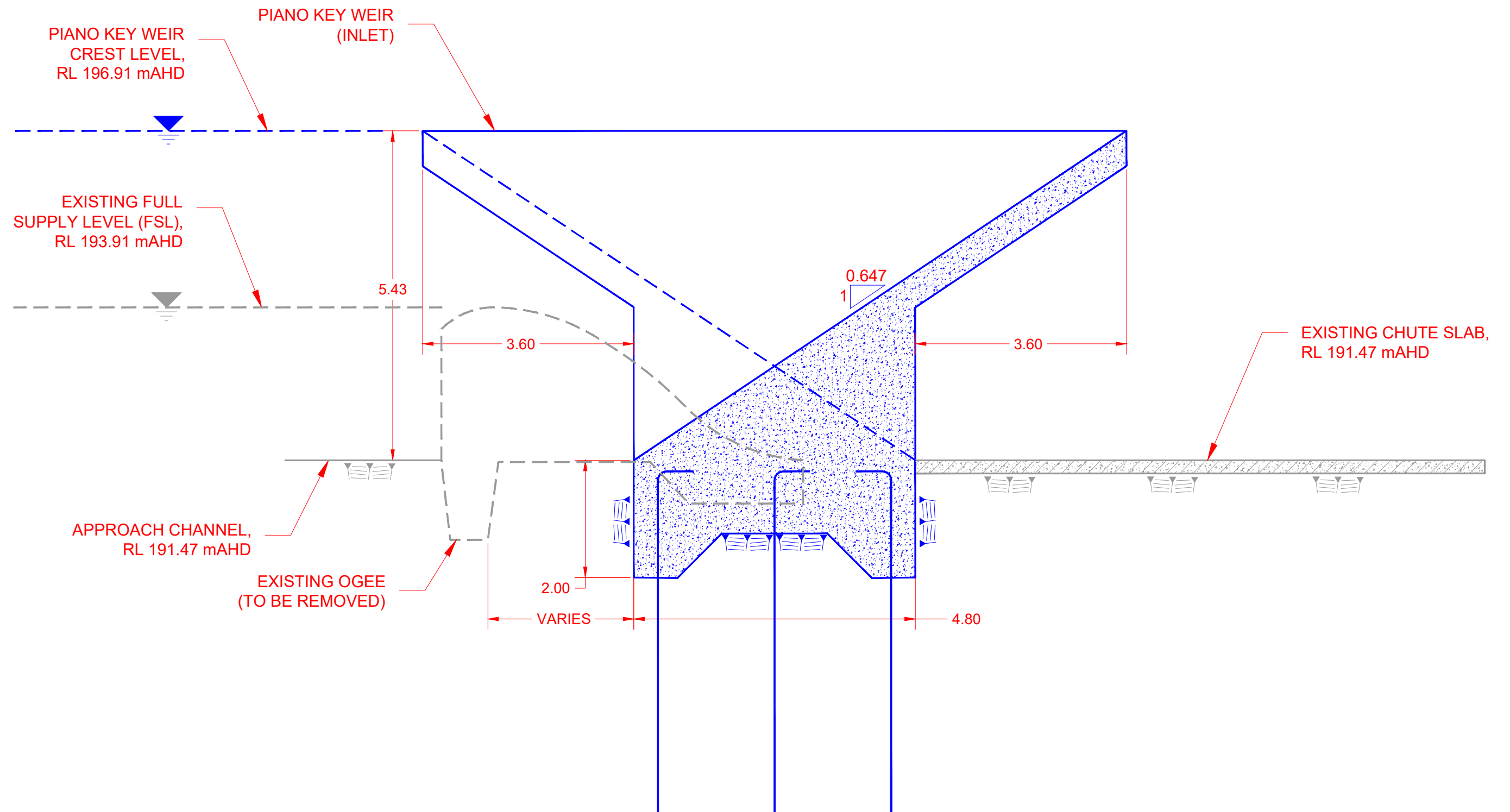

# Option: Piano key spillways

Plan view of secondary spillway

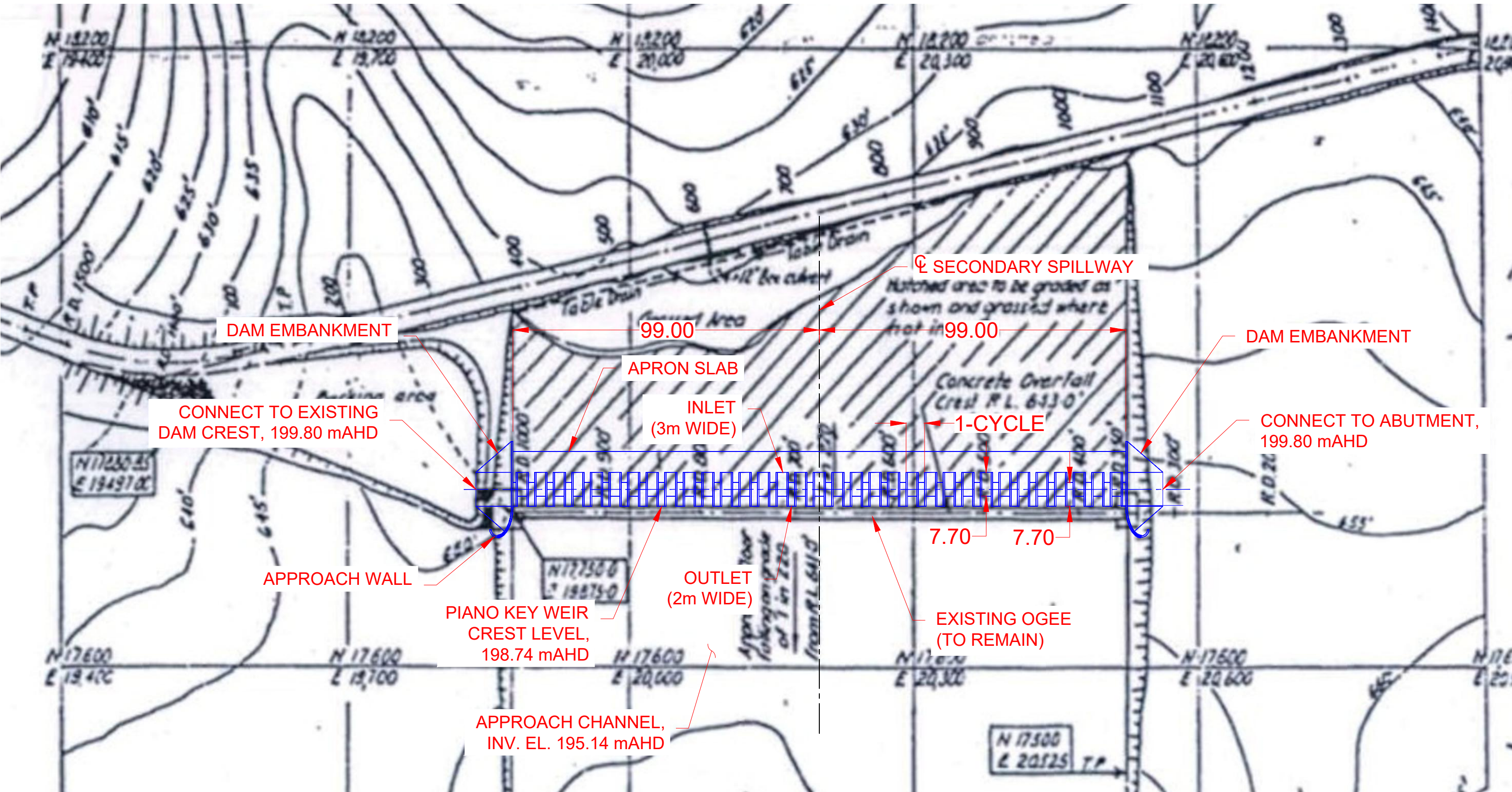

# Option: Piano key spillways

*Side view of secondary spillway*

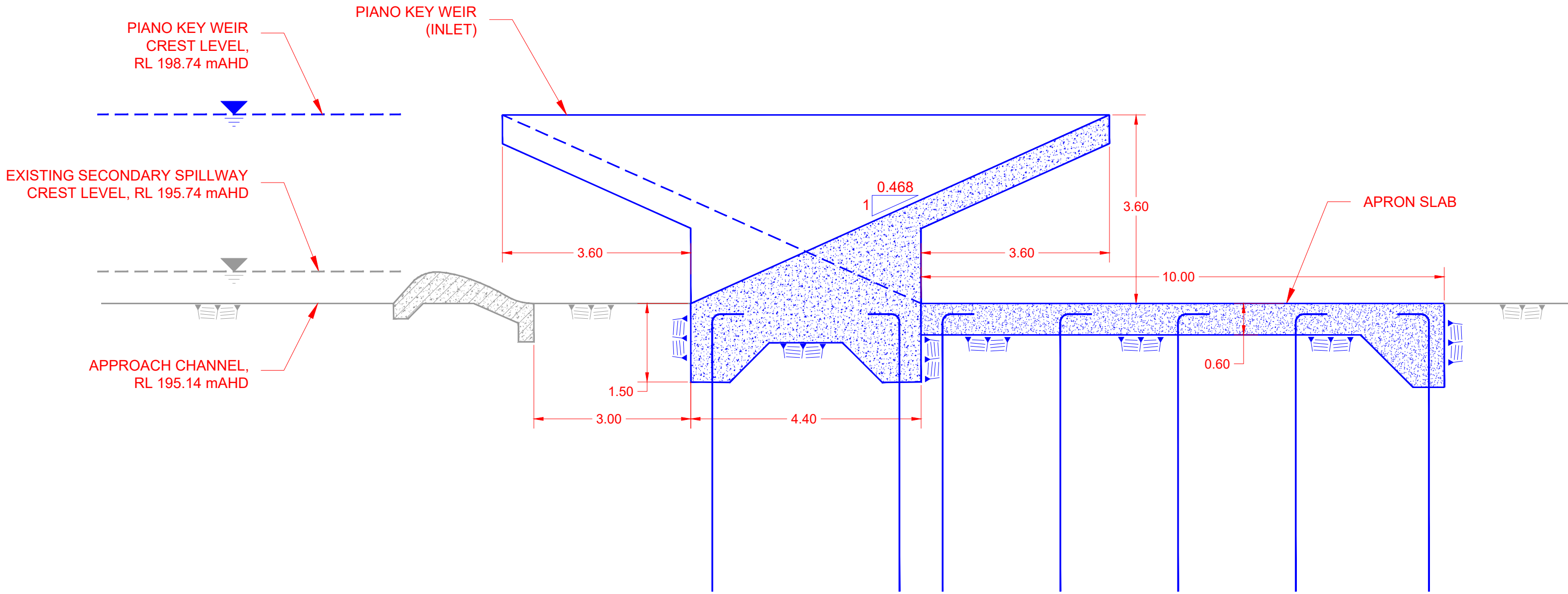

# Option: Piano key spillways

## Typical section for fuse plug

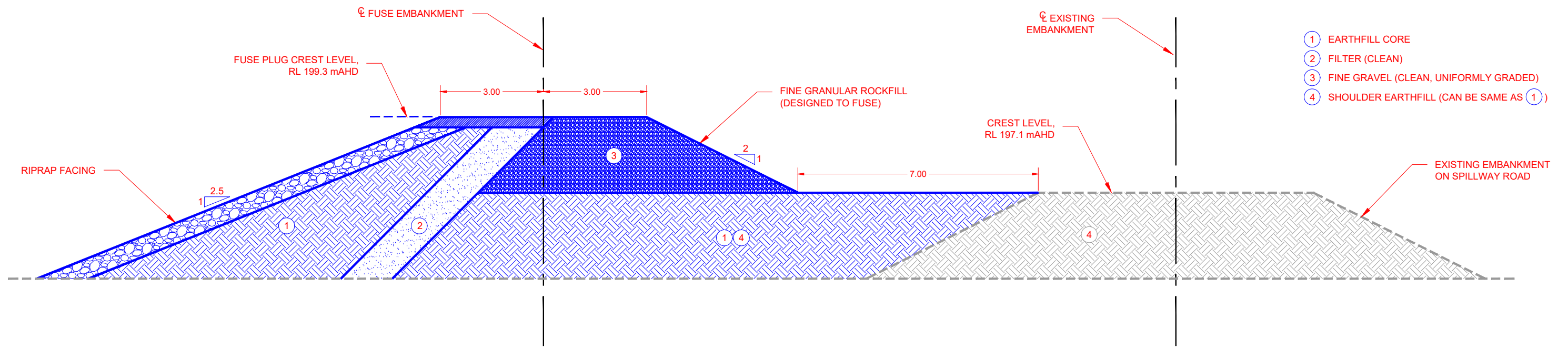

- ① EARTHFILL CORE
- ② FILTER (CLEAN)
- ③ FINE GRAVEL (CLEAN, UNIFORMLY GRADED)
- ④ SHOULDER EARTHFILL (CAN BE SAME AS ①)

NEW TERTIARY FUSEPLUG EMBANKMENT  
TYPICAL SECTION



## Appendix D Method to estimate flood damages

### Method outline

To assess the potential changes to the economic costs of flood damages if the options described in Section 4 were implemented, peak outflows from Lake Eppalock were correlated with estimates of tangible direct damages (in dollars) to:

- Buildings and contents
- Vehicles
- Roads and rail
- Agriculture

The steps involved were:

- Flood depths through Rochester as modelled by Water Technology (2013; 2018) for given flows at the Rochester syphon were overlaid on GIS databases of building and infrastructure types and locations (e.g. Map M5), and then the unit costs and depth-damage curves described below were applied to estimate the associated costs. The lower blue-dotted line in Figure 10 was used to convert peak flows at the Rochester syphon to an approximate peak spill from Lake Eppalock.
- For the area from downstream of Lake Eppalock to upstream of Rochester, a similar process was applied using flood depths modelled by HARC (2023) for a recent rapid flood risk assessment of the North Central CMA region.
- Upstream of Lake Eppalock, direct damages were estimated based on the assessment of additional buildings expected to be inundated if the spillway configuration is changed (Section 9).

Tangible indirect costs (e.g. emergency response, clean-up costs, transport disruption) were estimated as a proportion of the direct costs.

### Buildings and contents

#### *Destruction costs*

A building is 'destroyed' from an economic perspective once the cost of repairing it exceeds the cost of rebuilding. For this assessment, it was assumed that buildings are destroyed once the flood depth exceeded 3 m. The indicative reconstruction costs for destroyed non-residential buildings was based on unit rates in Blong (2003) adjusted for inflation, and estimates of building footprints available from Geoscape data and aerial photography. The value of stock and equipment lost in destroyed non-residential buildings depends on many factors and is therefore difficult to estimate without detailed ground surveys. To gain an indicative estimate, a content to structure ratio of 30% was applied. This is an average value for industrial and commercial buildings used by FEMA in their Benefit Cost Analysis Toolkit<sup>45</sup>.

---

<sup>45</sup> <https://www.fema.gov/grants/tools/benefit-cost-analysis#toolkit>



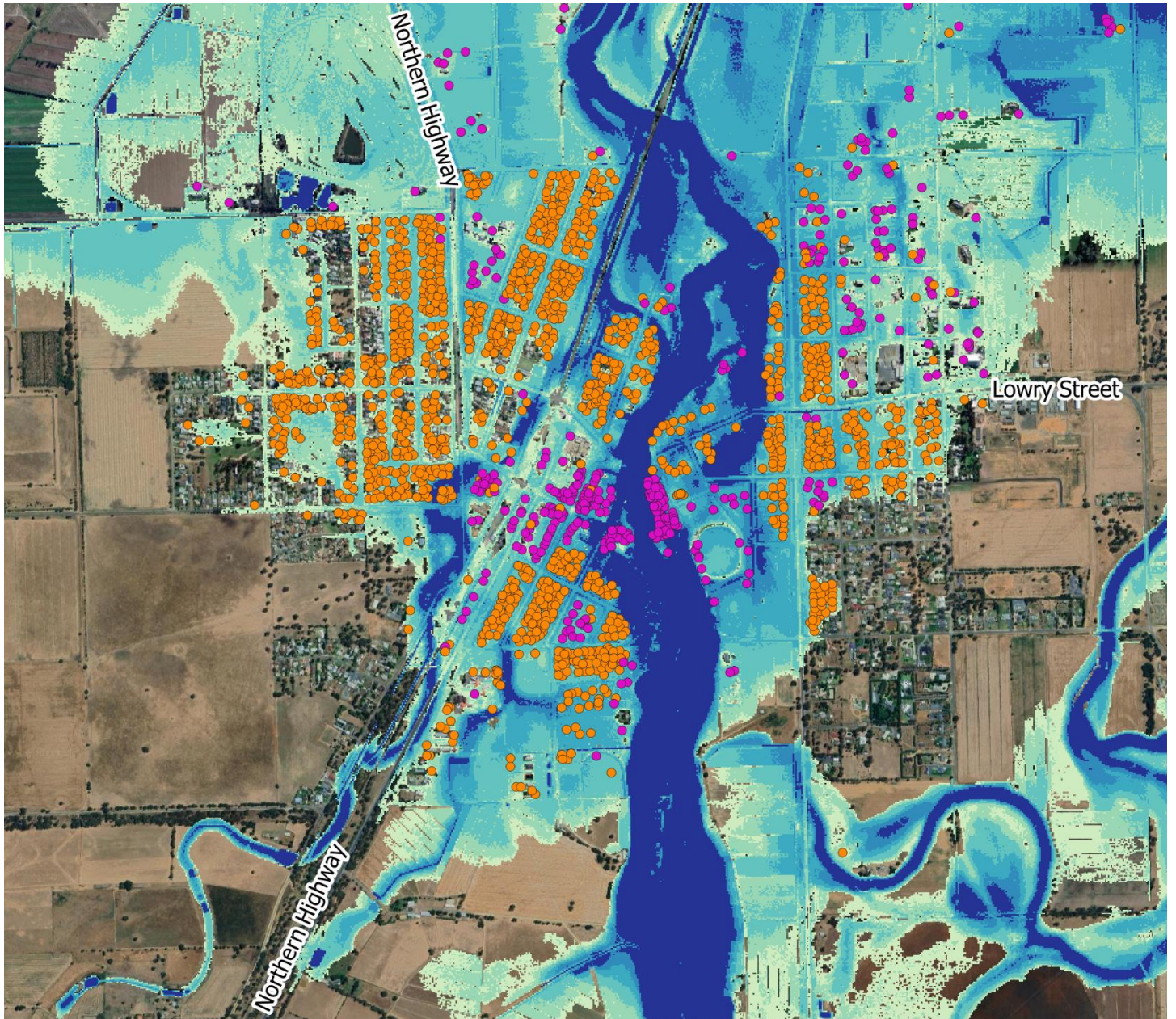

Legend

Modelled water depths (WaterTech 2018):

- <= 0.1 m
- 0.1 - 0.25 m
- 0.25 - 0.50 m
- 0.50 - 0.75 m

- 0.75 - 1.0 m
- 1.0 m >

- Inundated residential buildings
- Inundated non-residential buildings

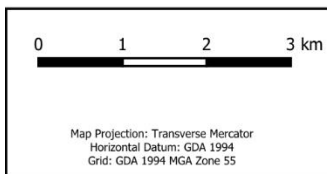

**Buildings in Rochester inundated by 74,000 ML/day at Rochester Syphon**

Job Number	VIC00115
Revision	A
Date	24 Oct 2023
Reviewed By	S. Lang
Created By	J. Tan
Map Number	VIC00115-M6



The indicative reconstruction cost and contents for destroyed residential buildings was based on 2021 data from NEXIS<sup>46</sup>. The residential contents value was calculated by applying the average value(s) of household contents, by dwelling structure, from the ABS Survey of Income and Housing (SIH)<sup>47</sup>, rounded to the nearest million \$AUD.

### Damage costs

Depth-damage curves were used to estimate the economic cost associated with damage to buildings and contents that are not destroyed. (Figure 69). The curve for residential buildings was based on guidance provided by NSW Environment and Heritage<sup>48</sup>, and the curve for non-residential buildings is from FEMA's Benefit Cost Analysis Tool (based on an average of individual curves for an office, school, light industrial property, retail clothing store and electronics store).

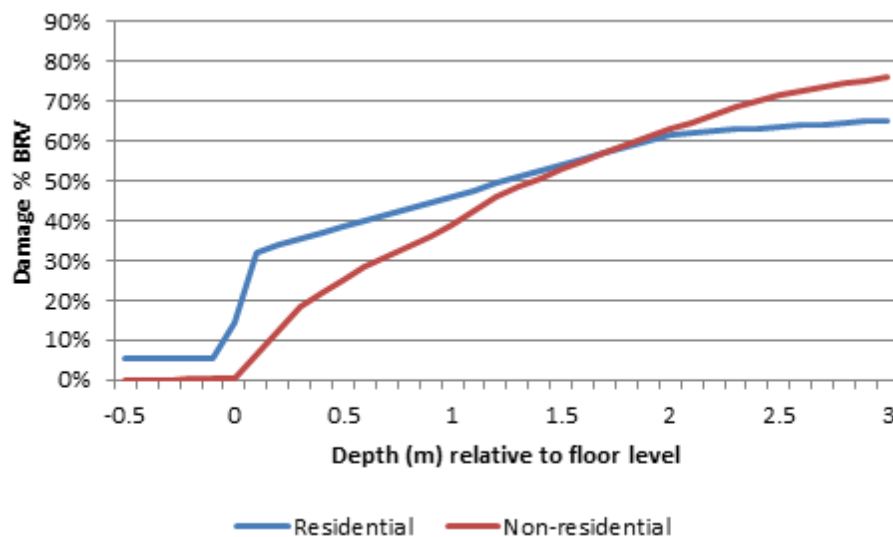

Figure 69: Estimated damage (building and contents) as a percent of building replacement value (BRV), for a given flood depth relative to floor level. Above ground but below floor-level flooding is represented by a negative depth.

### Vehicles

To estimate the direct damages to vehicles, it was estimated that on average one vehicle per inundated residence is saved from flooding. The vehicles remaining on properties where the residence is destroyed were assumed to be written-off, and half the vehicles on all other inundated residences were also assumed to be destroyed. There are 1.8 vehicles per household in Australia<sup>25</sup>. This means the expected economic cost from writing-off vehicles was estimated to be 0.8 vehicles per destroyed residential building, and 0.4 per damaged residential building.

<sup>46</sup> <https://researchdata.edu.au/national-exposure-information-1-sa1/1278205>

<sup>47</sup> <https://www.abs.gov.au/>

<sup>48</sup> <https://www.environment.nsw.gov.au/topics/water/floodplains/floodplain-guidelines>

The average vehicle is 10 years old<sup>49</sup>, and therefore the average depreciated value per vehicle was estimated to be \$28,860, based on prices for a similarly aged Toyota Hilux (which has been the highest selling car for nearly a decade on [www.carsguide.com.au](http://www.carsguide.com.au)).

## Roads and rail

Direct damages to roads and rail are generally a function of flood depth (Habermann and Hedel, 2018; Huizinga et al., 2017). Habermann and Hedel (2018) have estimated that, as a function of replacement costs, damage to roads and rail is approximately 20% for every 1 m of flooding. For example, if flood depth is 2 m the damage is 40% of the replacement cost, and for depths of 5 m and greater the road is likely to need replacing (i.e. the damage cost equals the replacement cost). Estimated replacement costs are shown in Table 36.

Table 36: Replacement costs for roads and rail

Infrastructure Type	Replacement cost (\$/m)
Walking track	50
Unsealed road	500
1 lane sealed road	1,500
2 lane sealed road	3,000
4 lane sealed road	5,000
Railway	5,000

## Agriculture

The indicative unit costs used to estimate agricultural losses from flooding were taken from the Rapid Appraisal Method (DNRE, 2000) and adjusted for inflation (Table 37). These unit costs are based on the assumption that the flooding will be of sufficient force and/or duration to result in re-establishment costs, clean-up costs and lost production, but there is a large degree of uncertainty associated with the values.

Table 37: Indicative unit costs for damage to agriculture from flooding

Type	Damage (\$/ha)
Dryland pastures	130
Dryland broadacre crops	200
Orchard	10,100
Grapes	4,300
Vegetables	10,000
Irrigated pastures	580
Irrigated broadacre crops	480

<sup>49</sup> <https://www.abs.gov.au/>



The Rapid Appraisal Method (DNRE, 2000) also provides a guide on indicative stock losses from flooding, in that expected losses can be estimated as 2 sheep and 0.5 cows per hectare inundated. The price of sheep (\$90/head) and cattle (\$850/head) was taken from the meat and livestock Australia web site<sup>50</sup>.

The Rapid Appraisal Method also says that “when calculating the cost of livestock lost during floods, the cost of carcass disposal should be considered. It is reasonable to suggest that the costs of livestock disposal will be in the order of \$6 to \$10 per sheep and \$40 to \$80 for cattle”. For this assessment, a disposal cost of \$8 per sheep and \$60 for cattle was adopted.

### Indirect costs

Examples of the indirect costs associated with flooding include emergency services and volunteers responding to the flood, clean-up costs and disruption to transport and utility services. For this assessment, general indirect costs were estimated to be 30% of the total direct damage costs.

### References

- Blong, R. (2003). *A New Damage Index*. Kluwer Academic Publishers, Netherlands.
- Department of Natural Resources and Environment (2000). *Rapid Appraisal Method (RAM) for Floodplain Management*. Report prepared by Read Sturgess and Associates.
- HARC (2023). *Rapid Flood Risk Assessment – North Central CMA Region; Campaspe River*. Report prepared for North Central CMA.
- Habermann, N. and Hedel, R. (2018). *Damage functions for transport infrastructure*. Fraunhofer Institute for Transportation and Infrastructure Systems, Germany.
- Huizinga, J., Moel, H. de, Szewczyk, W. (2017). *Global flood depth-damage functions. Methodology and the database with guidelines*. EUR 28552 EN. doi: 10.2760/16510.
- Water Technology (2013). *Rochester Flood Management Plan*. Report prepared for North Central Catchment Management Authority and Campaspe Shire Council.
- Water Technology (2018). *Rochester Mitigation Study*. Report prepared for Campaspe Shire Council.

---

<sup>50</sup> <https://www.mla.com.au/prices-markets/Trends-analysis/>



## Appendix E Future impacts of climate change

### Climate change in the Campaspe River catchment

Although there is high uncertainty, climate projections over Victoria point to drying conditions, driven by decreases in seasonal rainfall and increases in temperature. These changes are expected to interact to reduce soil moisture, and therefore both increase the demand for water and reduce reservoir inflows. The projected changes in annual rainfall, potential evapotranspiration and runoff in the Campaspe River catchment (DELWP, 2020) are summarised in Table 38 (the year 2040 projection for the RCP8.5 emissions scenario is used as an illustrative example).

Table 38: Projected change in hydroclimate variables in the Campaspe River catchment by 2040, relative to 1995, for the RCP8.5 emissions scenario (DELWP, 2020)

Climate impact scenario	Projected change (%) by 2040 compared with 1995, for RCP8.5 emissions scenario		
	Rainfall	Potential evaporation	Runoff
Low (10 <sup>th</sup> percentile)	2.4	3.0	10.5
Medium (50 <sup>th</sup> percentile)	-2.2	4.7	-12.3
High (90 <sup>th</sup> percentile)	-15.2	5.9	-37.3

At the same time, climate projections suggest there will be an increase in rainfall intensity, driven by an increase in atmospheric moisture as temperatures increase. The net effects of a drying climate but with higher rainfall intensities can lead to differences in trends depending on flood severity. For example, smaller floods which provide useful reservoir filling flows or ecologically-beneficial inundation are likely to be more sensitive to changes in soil moisture conditions compared with larger, more damaging floods, which are likely to be more sensitive to changes in rainfall intensities and volumes.

### Historical trends in floods

Research across Victoria has found that extreme rainfall intensities have been increasing over time (Wasko and Nathan, 2019). However, floods have been either increasing or decreasing in magnitude depending on their rarity. The cross-over point between this increasing or decreasing trend appears to be around the 10% AEP event (Wasko and Nathan, 2019). That is, floods more frequent than the “1 in 10” event appear to be decreasing in magnitude, and rarer, more severe floods appear to be increasing in magnitude, although this can vary by catchment. These observations (Figure 70) match the expected trends caused by climate change.

### Future climate projections for flooding

Continued climate change will have a progressively larger effect on floods, thus potentially accelerating historic trends. Increasing temperatures will increase rainfall intensities of long-duration events ( $\geq 24$  hours) by about 6-8% per degree of warming (Wasko et al., 2021). Rainfall intensities during shorter duration events will increase at a faster rate of about 15% per degree of warming (Wasko et al., 2021).

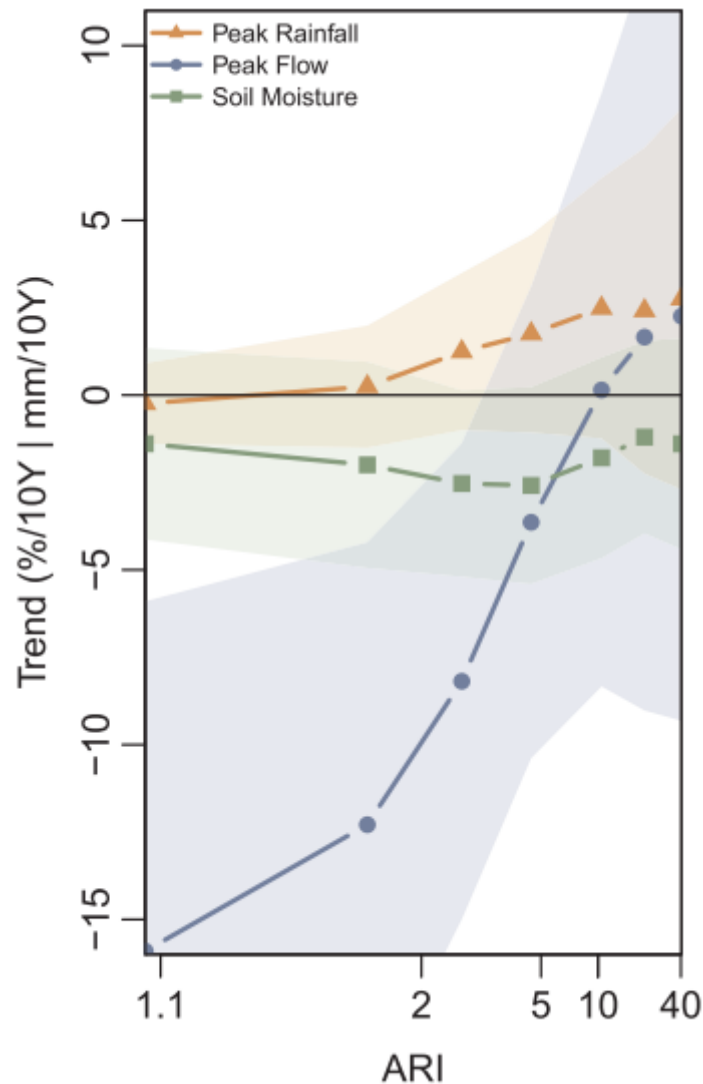

Figure 70: Average historic trend for peak rainfall, peak flow and soil moisture – across all sites assessed by Wasko and Nathan (2019) – versus the Average Recurrence Interval (ARI in years) of the peak rainfall. A 10-year ARI event is the same as a 10% or 1 in 10 annual exceedance probability (AEP) event. The thick lines show the mean trend, and the shaded interval represent one standard deviation. Source: Figure 7 of Wasko and Nathan (2019).

### Implications for reservoir and flood management

In the shorter term, the natural variability of Australia’s climate rather than climate change will be the dominate influence on Lake Eppalock storage and peak outflow behaviour. However, natural variability can also mask or enhance longer-term climate change. For example, some recent research suggests that the influence of climate change may exceed the influence of natural variability on long-term water entitlement yield in the Campaspe River catchment by 2040 (John et al., 2023).

Many of the options assessed in this report provide additional flood mitigation by reducing the target storage or FSL at Lake Eppalock below the current FSL. Whilst the effect of these options on water supply reliability can be offset via the purchase or retirement of entitlements, reducing the volumes stored at Lake Eppalock is likely to exacerbate for consumptive users the impacts of a drying climate.

In turn, there may also be some point in future when there is simultaneously reduced water availability in the Campaspe system because of a drying climate, and worse flooding because of increased rainfall intensities. In other words, it is likely that the flood mitigation benefits relative to current conditions of any change in reservoir operations or infrastructure at Lake Eppalock will be eroded as the climate continues to change.

Unfortunately, how to best quantitatively assess the impacts of climate change in the context of operating reservoirs for water supply and/or flood mitigation is an open research question. This is due to difficulties in combining water resource and flood modelling (mostly due to the complexities of models, uncertainties in future climate and differences in simulation time step required).

However, future work on potential operating and infrastructure options for increasing the flood mitigation provided by Lake Eppalock could be informed by using decision-making or similar processes recommended by Maier et al., (2016); Haasnoot et al. (2013) and John et al. (2021). These approaches can highlight potential adaptation options that deliver benefits despite climate change uncertainty. In any case, whatever operating or infrastructure options are implemented at Lake Eppalock will need to be adaptable in future to adequately cope with the expected continued climate change.

## References

- John, A., Horne, A., Nathan, R., Fowler, K., Webb, J. A. and Stewardson, M. (2021). *Robust climate change adaptation for environmental flows in the Goulburn River, Australia*. *Frontiers in Environmental Science*, 9, 573.
- John, A., Nathan, R., Horne, A., Fowler, K., Stewardson, M., Peel, M. and Webb, J. A. (2023). *The time of emergence of climate-induced hydrologic change in Australian rivers*. *Journal of Hydrology*, 619, 129371.
- Haasnoot, M., Kwakkel, J. H., Walker, W. E. and Ter Maat, J. (2013). *Dynamic adaptive policy pathways: A method for crafting robust decisions for a deeply uncertain world*. *Global environmental change*, 23(2), 485-498.
- Maier, H. R., Guillaume, J. H., van Delden, H., Riddell, G. A., Haasnoot, M. and Kwakkel, J. H. (2016). *An uncertain future, deep uncertainty, scenarios, robustness and adaptation: How do they fit together?* *Environmental modelling & software*, 81, 154-164.
- Wasko, C. and Nathan, R. (2019). *Influence of changes in rainfall and soil moisture on trends in flooding*. *Journal of Hydrology*, 575, 432-441.
- Wasko, C., Nathan, R., Stein, L. and O'Shea, D. (2021). *Evidence of shorter more extreme rainfalls and increased flood variability under climate change*. *Journal of Hydrology*, 603, 126994.